

**COST Action TU0901:  
Integrating and Harmonizing Sound Insulation Aspects  
in Sustainable Urban Housing Constructions**

# **Building acoustics throughout Europe Volume 2: Housing and construction types country by country**



*Chair:* Birgit Rasmussen  
SBI, Danish Building Research Institute  
Aalborg University  
Denmark

*Vice Chair:* María Machimbarrena  
Architecture School; Applied Physics Dpt.  
University of Valladolid  
Spain

Australia | Austria | Belgium | Canada | Croatia | Czech Republic | Denmark | Estonia | Finland | France | Germany  
Greece | Hungary | Iceland | Italy | Lithuania | Macedonia | Malta | Netherlands | New Zealand | Norway  
Poland | Portugal | Romania | Serbia | Slovakia | Slovenia | Spain | Sweden | Switzerland | Turkey | United Kingdom



### Editorial board:

Birgit Rasmussen, María Machimbarrena and Patrizio Fausti

### Revisors:

Teresa Carrascal, Ed Clarke, Patrizio Fausti, Eddy Gerretsen, Bart Ingelaere,  
María Machimbarrena, Jeffrey Mahn, Birgit Rasmussen

### Cover design:

Stefano Pedersoli

© COST Office and authors, [2014]

The responsibility and copyright of each chapter belongs to the author(s). When quoting, it is mandatory to make proper reference to the book and/or the authors of the quoted chapter. Permission from copyright holder is required in case of reproducing contents of images, diagrams, tables or other material from other copyright holders.

Neither the COST Office nor any person acting on its behalf is responsible for the use which might be made of the information contained in this publication. The COST Office is not responsible for the external websites referred to in this publication.

This book may be cited as:

Birgit Rasmussen & María Machimbarrena (editors), COST Action TU0901 –  
*Building acoustics throughout Europe. Volume 2: Housing and construction types  
country by country.*

This publication is supported by COST  
e-ISBN: 978-84-697-0159-1

Layout: DiScript Preimpresion, S. L.

Publisher: DiScript Preimpresion, S. L.

*COST - European Cooperation in Science and Technology is an intergovernmental framework aimed at facilitating the collaboration and networking of scientists and researchers at European level. It was established in 1971 by 19 member countries and currently includes 35 member countries across Europe, and Israel as a cooperating state.*

*COST funds pan-European, bottom-up networks of scientists and researchers across all science and technology fields. These networks, called 'COST Actions', promote international coordination of nationally-funded research.*

*By fostering the networking of researchers at an international level, COST enables break-through scientific developments leading to new concepts and products, thereby contributing to strengthening Europe's research and innovation capacities.*

*COST's mission focuses in particular on:*

- *Building capacity by connecting high quality scientific communities throughout Europe and worldwide;*
- *Providing networking opportunities for early career investigators;*
- *Increasing the impact of research on policy makers, regulatory bodies and national decision makers as well as the private sector.*

*Through its inclusiveness, COST supports the integration of research communities, leverages national research investments and addresses issues of global relevance.*

*Every year thousands of European scientists benefit from being involved in COST Actions, allowing the pooling of national research funding to achieve common goals.*

*As a precursor of advanced multidisciplinary research, COST anticipates and complements the activities of EU Framework Programmes, constituting a "bridge" towards the scientific communities of emerging countries. In particular, COST Actions are also open to participation by non-European scientists coming from neighbour countries (for example Albania, Algeria, Armenia, Azerbaijan, Belarus, Egypt, Georgia, Jordan, Lebanon, Libya, Moldova, Montenegro, Morocco, the Palestinian Authority, Russia, Syria, Tunisia and Ukraine) and from a number of international partner countries.*

*COST's budget for networking activities has traditionally been provided by successive EU RTD Framework Programmes. COST is currently executed by the European Science Foundation (ESF) through the COST Office on a mandate by the European Commission, and the framework is governed by a Committee of Senior Officials (CSO) representing all its 35 member countries.*

*More information about COST is available at [www.cost.eu](http://www.cost.eu).*

## Preface

Neighbour noise is a significant problem having had insufficient attention for decades, both for existing housing and new housing. Time had come to solve the challenges by establishing a common framework in building acoustics throughout Europe. As a consequence, the research network, COST Action TU0901 “Integrating and Harmonizing Sound Insulation Aspects in Sustainable Urban Housing Constructions” was established to initiate and support a process towards such framework.

COST TU0901 considered the main tool to be an acoustic classification scheme for dwellings –implying definition of a number of quality classes– combined with knowledge about housing constructions complying with the class criteria.

During the four years official lifetime of COST TU0901, close research cooperation and discussions have taken place between around 90 experts from 29 European countries and 3 overseas countries participating in COST TU0901. Most of the work was done in or through the three TU0901 working groups.

The findings from COST TU0901 are presented in two books with the joint main title “Building acoustics throughout Europe”. Volume 1 describes the background, the current situation and the main findings from the working groups. Volume 2 consists of country chapters describing the national housing stock, construction types and related sound insulation performance in countries involved in COST TU0901.

We hope all the work presented herein will be used to meet our main objective, which is no other than providing “sustainable, quieter homes all over Europe” –and maybe beyond–.

The cooperation initiated in COST TU0901 will continue in many ways, including standardization groups and research projects, thus supporting the process towards quieter European homes.

April 2014

Birgit Rasmussen – Chair of COST TU0901

María Machimbarrena – Vice Chair of COST TU0901

# Contents

<b>Preface</b> .....	4
<b>Introduction</b>	
<i>Sean Smith, Patrizio Fausti</i> .....	8
<b>Chapter 1. Austria</b>	
<i>Judith Lang, Herbert Muellner</i> .....	11
<b>Chapter 2. Belgium</b>	
<i>Bart Ingelaere</i> .....	35
<b>Chapter 3. Croatia</b>	
<i>Marko Horvat</i> .....	75
<b>Chapter 4. Czech Republic</b>	
<i>Jiri Novacek</i> .....	92
<b>Chapter 5. Denmark</b>	
<i>Dan Hoffmeyer, Birgit Rasmussen</i> .....	102
<b>Chapter 6. Estonia</b>	
<i>Marko Ründva, Linda Madalik</i> .....	119
<b>Chapter 7. Finland</b>	
<i>Heikki Helimäki, Matias Remes, Pekka Taina</i> .....	131
<b>Chapter 8. France</b>	
<i>C. Guigou-Carter, J.-L. Kouyoumji, N. Balanant, J.-B. Chéné</i> .....	149
<b>Chapter 9. Germany</b>	
<i>Martin Schneider, Andreas Ruff, Heinz-Martin Fischer</i> .....	170
<b>Chapter 10. Greece</b>	
<i>Konstantinos Vogiatzis</i> .....	179
<b>Chapter 11. Hungary</b>	
<i>A. B. Nagy, G. Józsa</i> .....	189
<b>Chapter 12. Iceland</b>	
<i>Steindór Guðmundsson</i> .....	202

<b>Chapter 13. Italy</b>	
<i>P. Fausti, S. Secchi, A. Di Bella, F. Scamoni</i> .....	214
<b>Chapter 14. Lithuania</b>	
<i>Vidmantas Dikavicius, Kestutis Miskinis</i> .....	238
<b>Chapter 15. Macedonia</b>	
<i>Todorka Samardzioska</i> .....	259
<b>Chapter 16. Malta</b>	
<i>Vincent Buhagiar, Noella Cassar</i> .....	273
<b>Chapter 17. Netherlands</b>	
<i>Wim Beentjes</i> .....	285
<b>Chapter 18. Norway</b>	
<i>Clas Ola Høsøien, Iiris Turunen-Rindel</i> .....	314
<b>Chapter 19. Poland</b>	
<i>A. Izewska, B. Szudrowicz, R. Ciszewski</i> .....	323
<b>Chapter 20. Portugal</b>	
<i>Julieta António, Jorge Patrício, Sónia Antunes</i> .....	335
<b>Chapter 21. Romania</b>	
<i>Marta Cristina Zaharia, Mirel Florin Delia</i> .....	352
<b>Chapter 22. Serbia</b>	
<i>Miomir Mijić, Ana Radivojević, Dragana Šumarac Pavlović, Draško Mašović, Milica Jovanović Popović, Dušan Ignjatović, Aleksandar Rajčić</i> .....	373
<b>Chapter 23. Slovakia</b>	
<i>Juraj Medved', Vojtech Chmelík, Andrea Vargová</i> .....	388
<b>Chapter 24. Slovenia</b>	
<i>M. Ramšak, M. Čudina</i> .....	415
<b>Chapter 25. Spain</b>	
<i>T. Carrascal García, M. Machimbarrena, C. Monteiro</i> .....	427

<b>Chapter 26. Sweden</b>	
<i>K. Larsson, K. Hagberg, C. Simmons</i> .....	453
<b>Chapter 27. Switzerland</b>	
<i>Victor Desarnaulds</i> .....	471
<b>Chapter 28. Republic of Turkey</b>	
<i>Selma Kurra</i> .....	504
<b>Chapter 29. United Kingdom</b>	
<i>Sean Smith, Ed Clarke</i> .....	523
<b>Chapter 30. Australia</b>	
<i>John Laurence Davy</i> .....	541
<b>Chapter 31. New Zealand</b>	
<i>Jeffrey Mahn</i> .....	563



# Building acoustics throughout Europe

## Volume 2: Housing and construction types country by country

### Introduction

Authors:  
**Sean Smith**  
**Patrizio Fausti**

<sup>1</sup> Institute for Sustainable Construction, Edinburgh Napier University, Edinburgh, UK  
e-mail: [se.smith@napier.ac.uk](mailto:se.smith@napier.ac.uk)

<sup>2</sup> Engineering Department of the University of Ferrara, Italy  
e-mail: [patrizio.fausti@unife.it](mailto:patrizio.fausti@unife.it)



## Introduction

This book covering key aspects of building acoustic construction for dwellings found in 31 countries is the second volume of “Towards a common framework in European building acoustics”. It represents some of the main discussions and gathering of data undertaken by Working Group 3 (WG3) of COST Action TU0901 and also participating country members from WG1 and WG2.

TU0901 provided the platform to bring 32 countries together to discuss, share research findings and also plan future joint research towards improving the quality of life for future residential occupants through a more harmonized approach to sound insulation.

To undertake the purpose of data gathering across so many countries “project mosaic” was initiated by WG3 members. There was a rich diversity of data, databases, building systems and solutions found across the participating countries. The interim regular meetings of the COST Action TU0901 over 4 years allowed “project mosaic” data to be gathered and presented at each meeting. This allowed a better understanding of each country, the differences and similarities in building design, construction materials, innovative products and common workmanship factors.

This compilation of 31 countries data is not an exhaustive review of each country but provides more specific details and sound insulation performance characteristics than Volume 1 Chapters 9, 10 and 11 giving information across all countries. In addition, in this Volume 2, various data is also presented including construction details, historical trends, building regulations and guidance found in countries.

As with energy systems for buildings involving thermal mass of concrete, so acoustics construction systems for walls and floors in heavyweight materials provide mass and stiffness. Similarly the multi-component lightweight wall and floor systems involve properties of isolation, resilience and stiffness which have an important role in reducing sound transmission. There are clear geographical similarities across countries such as central and southern Europe using perforated clay block wall systems and parts of northern Europe using more lightweight timber construction. Nevertheless commonalities in the use of concrete systems, lightweight steel and screed floor finishes are found across all countries.

The construction details, sound insulation data and information presented in this Volume 2 would not have been possible without the contributions of the key authors and their colleagues for each country. We wish to thank all of the WG3 participants and all of the chapter authors for the information they have provided which provides a unique acoustic tapestry of building acoustics not only in Europe but also Australia and New Zealand.

It is the hope that the COST TU0901 books will be a milestone towards continued exchange of construction solutions and data between all countries and that learning from each other will facilitate the process towards quieter European homes.



# Building acoustics throughout Europe

## Volume 2: Housing and construction types country by country



**Austria**

Authors:

**Judith Lang<sup>1</sup>**

**Herbert Muellner<sup>1</sup>**

<sup>1</sup> Federal Institute of Technology TGM, Vienna, Austria



## CHAPTER

## 1

## Austria

## 1.1. Introduction

An extensive study in 1974 on the sound insulation in residential buildings in Austria [1] gave basic data for requirements on sound insulation and their fulfilment in Austria. A large number of questionnaires on audibility and annoyance of neighbours noise and their comparison with results of sound insulation measurements gave the findings that  $R'$  does not ensure the same subjective assessment for floors and walls with different areas. Therefore the requirement was changed to  $D_{nT'}$  and many measurements showed that the reverberation time in furnished rooms in residential buildings is about 0.5 seconds.

In Austria therefore the standardized sound level difference  $D_{nT,w}$  is used to define sound insulation requirements since decades. For impact sound insulation also the standardized impact sound level difference  $L'_{nT,w}$  is used.  $D_{nT,w} \geq 55$  dB and  $L'_{nT,w} \leq 48$  dB were derived from the results of the questionnaires and are still the minimum requirements.

The measurements showed also the importance of flanking transmission and in 1974 first appropriate combinations of partitions and flanking elements were published.

Adequate calculation schemes were published already in 1981 and standardized in 1992 and then replaced by EN 12354.

To assist planners, tables were established with adequate combinations of partitions with flanking elements and of floors with flanking elements to fulfil the minimum requirement  $D_{nT,w} \geq 55$  dB. In ÖNORM B 8115-4 there is a table for partitions to be combined with adequate flanking floors and walls. A similar table gives the walls to be used in combination with different floors.

Higher classes of sound insulation have been published in ÖNORM B 8115-5 in 2012 based on  $D_{nT,w} + C_{50-5000}$  and  $L'_{nT,w} + C_{1,50-2500}$  as studies have shown the importance of the low frequencies. In the higher classes requirements are not only defined for the sound insulation between adjacent flats but also between rooms in the same flat (if wanted and set in planning stage), especially also to be applied to detached houses.

## 1.2. Overview of housing stock

Slightly less than four fifths of all buildings in Austria are residential buildings with one or two dwellings. One building out of nine is a residential building with three or more dwellings, 9.9% are non-residential buildings. By contrast only 45.3% of all dwellings are located in residential buildings with a maximum of two dwellings. 21.6% are located in residential buildings with three to ten dwellings, 29.9% are in residential buildings with 11 or more dwellings, and only 2.9% of the dwellings are located in buildings that primarily serve commercial, industrial or cultural purposes or the provision of services [2, 3].

Tables 1.1 and 1.2 below show the number of buildings and number of dwellings in residential buildings in the years 1951 – 2011 and 1971 – 2011 respectively.

*Table 1.1. Number of buildings and dwellings, 1951 – 2011 [2].*

1951	1961	1971	1981	1991	2001	2011
<b>Buildings</b>						
896030	1049953	1281114	1586841	1809060	2046712	2191280
<b>Conventional dwellings</b>						
2138001	2249678	2666048	3052036	3393271	3863262	4441408

*Table 1.2. Number of dwellings in the building, 1971 – 2011 [3].*

Topic	1971	1981	1991	2001	2011
<b>Buildings in total</b>	1281114	1586841	1809060	2046712	2191280
<b>Number of dwellings in the building</b>					
No dwelling	71468	150011	168457	216659	143377
1 dwelling	882552	1068596	1231861	1354020	1491566
2 dwellings	189098	205231	230848	264017	298766
3 to 5 dwellings	62486	64358	68090	80496	102236
6 to 10 dwellings	36895	46683	54945	69886	83537
11 to 20 dwellings	25287	37809	40753	46189	53487
21 or more dwellings	13328	14153	14106	15445	18311



### *The most populated cities*

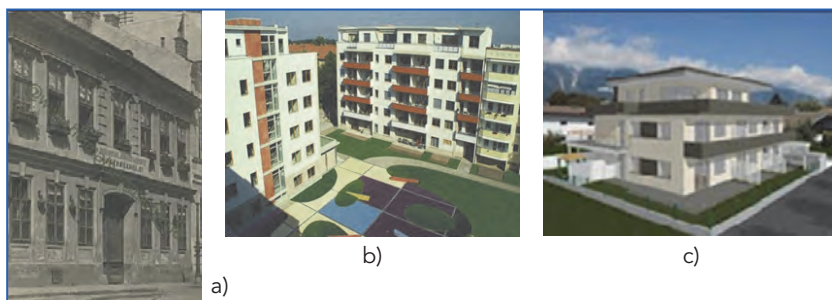
The total population in Austria is 8.42 million (data from 2011). The most populated cities (data from 2006) are the capital Vienna (1.66 million), Graz (0.25 million), Linz (0.19 million), Salzburg (0.15 million), Innsbruck (0.12 million).

## 1.3. New build housing constructions

### 1.3.1. Overview

The constructions are more or less similar since 1980. Mainly the traditional mode of construction with brick walls and concrete floors is applied. In the last decade, however, timber constructions have become increasingly common. In 2008, for example, 13 % of multifamily houses were built in timber.

Figures 1.1 and 1.2 below show some examples of typical residential buildings of different construction periods, detached and terraced houses.

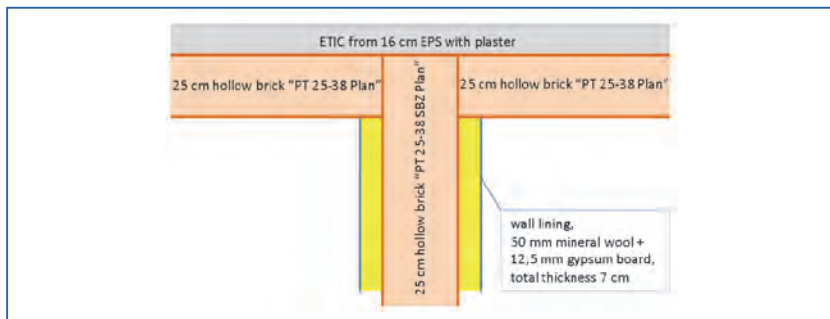


**Figure 1.1.** Residential buildings: a) first half 20<sup>th</sup> century; b) 2000; c) 2010.


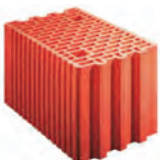



**Figure 1.2.** a) detached house, 2000; b) terraced house, 2005.

### 1.3.2. Typical heavy constructions




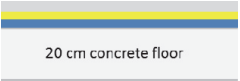


**Figure 1.3.** Example of a typical partition and outer walls in brickwork with typical concrete floor with floating screed.

Partition	
<p>25 cm hollow brick "PT 25-38 SBZ Plan" (15,1 kg), with concrete filling 425 kg/m<sup>2</sup>, with plaster 450 kg/m<sup>2</sup></p> <p>on both sides wall lining consisting of 50 mm mineral wool + 12.5 mm gypsum board, total thickness 7 cm</p>	
Flanking walls	
<p>25 cm hollow brick "PT 25-38 Plan" (18.6 kg), inside plaster, outside ETIC from 16 cm EPS with plaster, total weight 225 kg/m<sup>2</sup>, R'<sub>w</sub> = 47 dB</p>	
Flanking floor	
<p>5 cm floating concrete screed                      3.5 cm mineral wool "TDPS" CP4, s' = 9 MN/m<sup>3</sup>                      5 cm polystyrene-concrete 350 kg/m<sup>3</sup>                      20 cm reinforced concrete slab                      total mass 480/kg/m<sup>2</sup></p> <p>All walls and bearing concrete slab rigid contact</p>	

**Figure 1.4.** Typical partition in brickwork (c.f. Figure 1.3) with typical concrete floor with floating screed, partition with 2 flexible layers, example A

$$D_{nT,w} (C; C_{tr}) = 60 (-8; -16) \text{ dB.}$$

Partition	
<p>25 cm hollow brick "PT 25-50 SBZ Plan" (19.2 kg), with concrete filling 410 kg/m<sup>2</sup>, with plaster 435 kg/m<sup>2</sup></p> <p>on both sides flexible layer VSDP drywall lining, sticking mortar-35 mm mineral wool (s' = 9MN/m<sup>3</sup>)-plaster (total thickness 7 cm)</p>	
Flanking outer wall	
<p>25 cm hollow brick "PT 25 Plan" (18.6 kg), inside plaster, outside ETIC from 14 cm EPS with plaster, total mass 240 kg/m<sup>2</sup></p>	
Flanking inner wall	
<p>20 cm hollow brick "PT 20-40 Plan" (22.1 kg), on both sides plaster, total mass 250 kg/m<sup>2</sup></p>	
Flanking floor	
<p>5 cm floating concrete screed                      3.5 cm mineral wool "TDPS" CP4, s' = 9 MN/m<sup>3</sup>                      5 cm Styropor-concrete 350 kg/m<sup>3</sup>                      20 cm reinforced concrete slab                      total mass 480/kg/m<sup>2</sup></p> <p>All walls and load bearing floor rigid contact</p>	

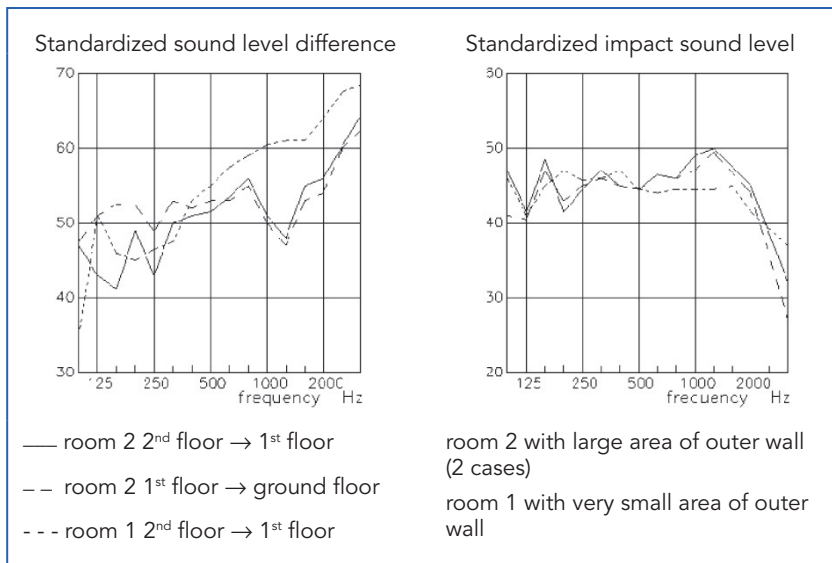
**Figure 1.5.** Typical partition in brickwork (c.f. Figure 1.3) with typical concrete floor with floating screed, partition with 2 flexible layers, example B  
 $D_{nT,w} (C; C_{tr}, C_{50-3150}, C_{tr,50-3150}) = 58 (-3; -9; -4; -13) \text{ dB}$ .

### 1.3.3. Typical errors in design and workmanship (heavy constructions)

A flanking wall reduces airborne and impact sound insulation between two rooms one above the other as shown in the sound insulation characteristics in Figure 1.6 below.



A hollow brick wall with a resonance frequency at 1250 Hz flanking a heavy floor with floating screed causes a considerable dip at this resonance frequency in airborne and impact sound insulation between the two rooms separated by the flanked floor.

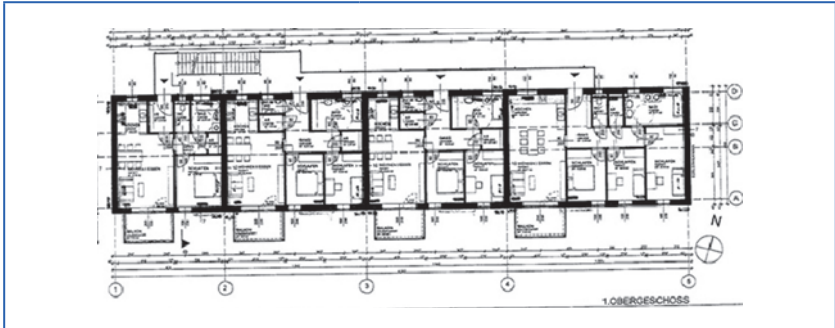


**Figure 1.6.** Flanking wall reduces airborne and impact sound insulation between two rooms one above the other.

### 1.3.4. Typical lightweight constructions



**Figure 1.7a.** Example of a new residential building in timber construction (2010).



Floor	Party wall
70 mm concrete screed 20 mm mineral wool TDPS 25/20 80 mm loose fill 20 mm mineral wool TDPT 20/20 147 mm CLT cross laminated timber 350 kg/m <sup>2</sup>	12.5 mm gypsum fibre board 50 mm cellulose insulation 15 mm gypsum fibre board 22 mm OSB 100 mm timber studs in between mineral wool 20 mm air space 100 mm timber studs in between mineral wool 22 mm OSB 15 mm gypsum fibre board 50 mm cellulose insulation 12.5 mm gypsum fibre board 120 kg/m <sup>2</sup>
Façade	Inner wall
2 x 12.5 mm gypsum fibre board 100 mm mineral wool 22 mm OSB 200 mm cellulose insulation in wooden construction 13 mm MDF 50 mm cork insulation 10 mm plaster 60 kg/m <sup>2</sup>	12.5 mm gypsum fibre board 100 mm timber studs, in-between mineral wool 12.5 mm gypsum fibre board 40 kg/m <sup>2</sup>

**Figure 1.7b.** Example of a new residential building in timber construction (2010), description of the components.

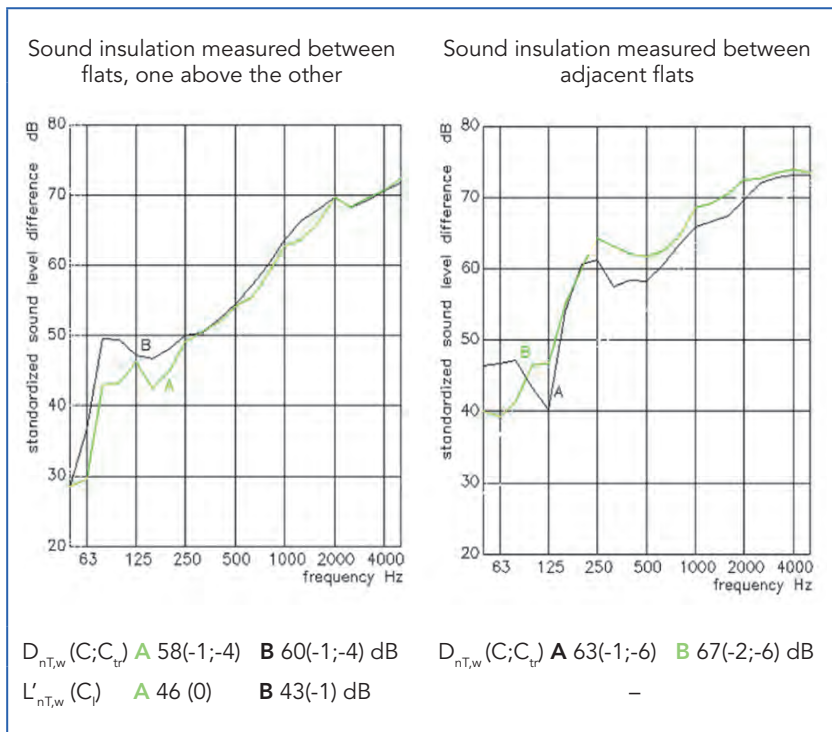


Figure 1.8. Results of sound insulation measurements in the houses A and B.

### 1.3.5. Example for construction of wall and floor and the relevant connections in a multi-family house built in timber and timber frame construction mode (1990-2000)

In the last few decades, a growing number of multi-storey apartment houses have been built in Austria using timber constructions. When measuring the sound insulation of these buildings, it was found that with proper workmanship (particularly for the wall and floor connections) a high level of sound insulation can be achieved. For instance, when measuring the sound insulation in a multi-family house where the walls and floors had been constructed according to the shown figures the following weighted standardized sound level differences were found:  $D_{nT,w} = 64$  dB (c.f. Figure 1.12) between adjacent rooms and  $D_{nT,w} = 56$  dB between rooms located on top of each other.

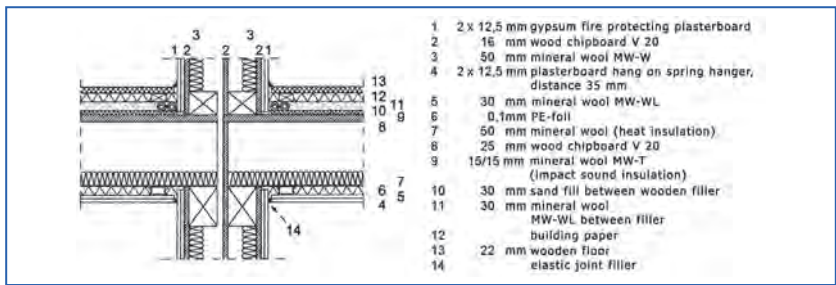


Figure 1.9. Connection between wall separating flats and floor (vertical section).

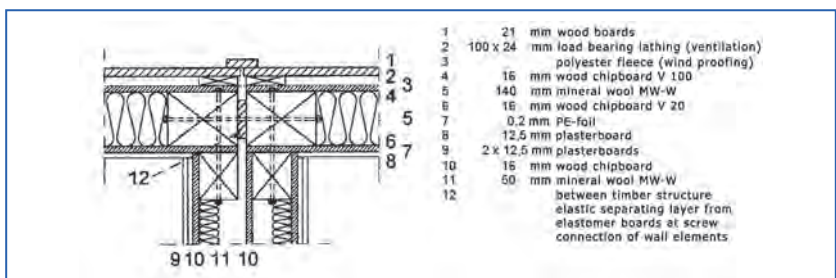


Figure 1.10. Connection between outer wall and wall separating flats (horizontal section).

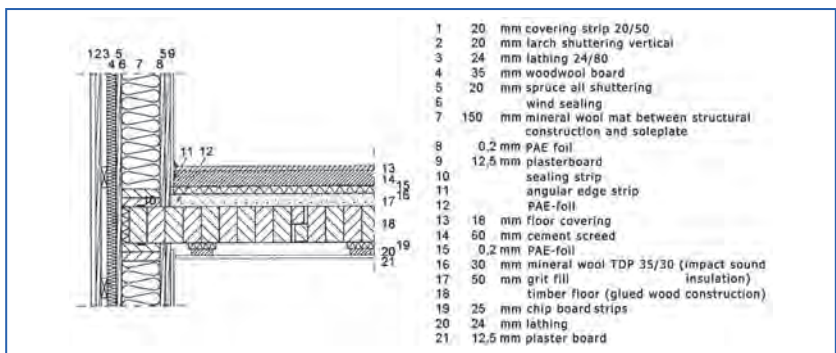


Figure 1.11. Connection between outer wall and floor (vertical section).

Remarks:

In Figure 1.9, the wooden floor covering used in this case is not very often used; gypsum board on mineral wool is the most used floor in timber buildings.



In Figure 1.10, the outer wall is now usually constructed with higher thickness of mineral wool No. 5.

In Figure 1.11, the chip board strips No.19 may not always be used.

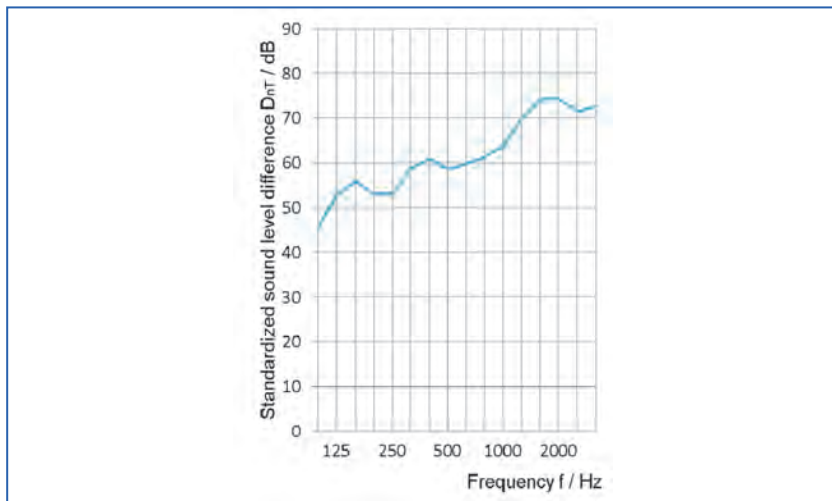


Figure 1.12. Standardized sound level difference between adjacent flats  
 $D_{nT,w} = 64$  dB.

### 1.3.6. Typical errors in design and workmanship (in general)

#### Inappropriate arrangement of adjacent rooms

In ground plans in residential buildings **noise producing rooms like bathroom or kitchen are often planned adjacent to bedrooms**. The noise from technical equipment intrudes into the living room or sleeping room and causes annoyance, especially during the night time.

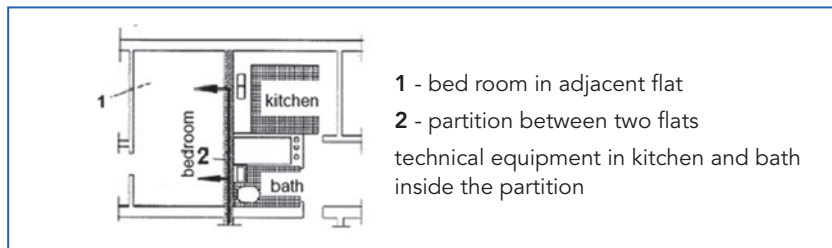


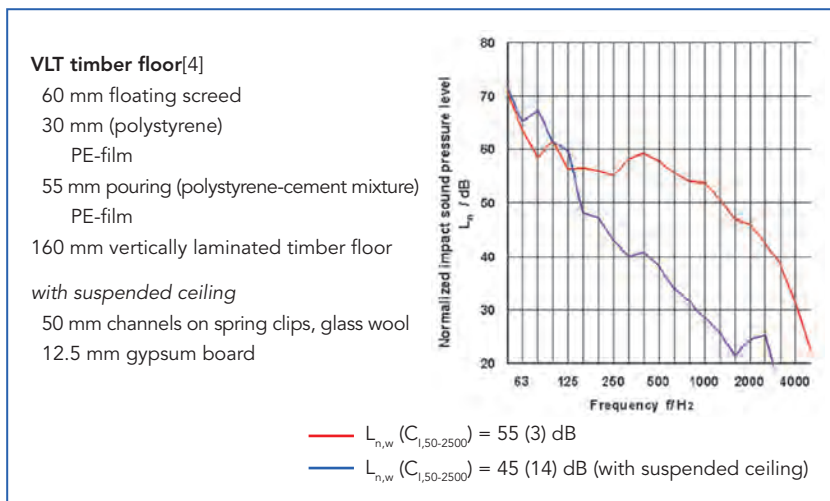
Figure 1.13. Disadvantageous arrangement of the adjacent rooms.



### 1.3.7. Typical errors in design and workmanship (light weight constructions)

Inappropriate suspended ceiling on a floor reduces airborne and impact sound insulation caused by resonance.

Often a ceiling consisting from a flexible layer on mineral wool is planned to increase the airborne or the impact sound insulation of floors. However the sound insulation may be worsened in the low frequency range by this ceiling, caused by the resonance frequency of the flexible layer which is often in the range of 50-80 Hz.



**Figure 1.14a.** Inappropriate suspended ceiling reduces airborne and impact sound insulation, example VLT timber floor.

#### Influence of position of the screws in gypsum board walls

Close to the free edge of the profile or close to the opposite edge [5] leads to different sound insulation characteristics.

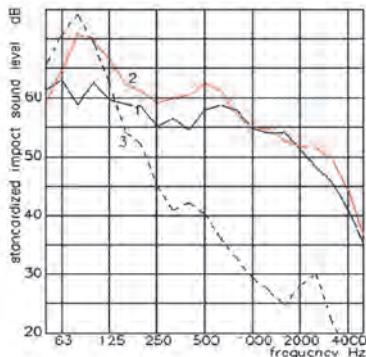
#### Inappropriate mounting of flexible layer on heavy wall (dry lining systems)

“Roofing compound” (30 mm mineral wool +12,5 mm gypsum board) fixed to wall with “mortar points” (too many, too stiff) causes high resonance frequency with a dip in the sound insulation curve.



**CLT timber floor**

- 1 60 mm concrete screed  
30 mm mineral wool  
50 mm gravel
- 2 59 mm concrete screed  
33 mm EPS  
54 mm gravel
- 3 like 2 with ceiling of  
15 mm gypsum board  
50 mm spring clips systems, mineral  
wool in the gap

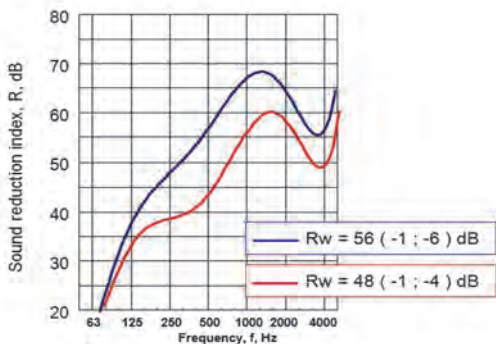


- 1  $L_{n,w}(C_r; C_{1,50-2500}) = 58 (-4; -2)$  dB
- 2  $L_{n,w}(C_r; C_{1,50-2500}) = 61 (-2; 0)$  dB
- 3  $L_{n,w}(C_r; C_{1,50-2500}) = 50 (5; 12)$  dB

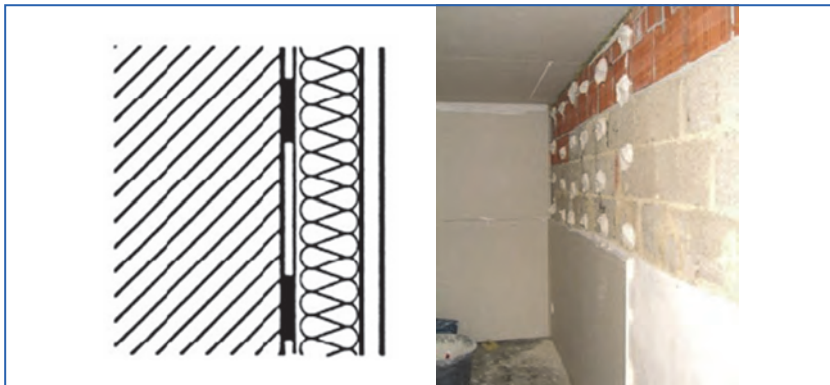
**Figure 1.14b.** Inappropriate suspended ceiling reduces airborne and impact sound insulation, example CLT timber floor.



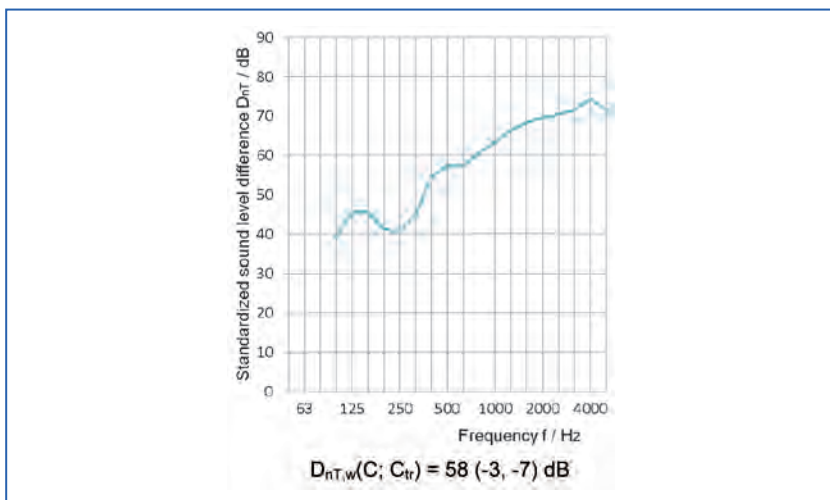
**Figure 1.15.** Position of the screws: left optimal, right suboptimal.



**Figure 1.16.** Sound reduction index of gypsum board walls with optimal (blue graph) and suboptimal (red graph) screw positions



**Figure 1.17a.** Inappropriate mounting of flexible layer on heavy wall.



**Figure 1.17b.** Inappropriate mounting of flexible layer on heavy wall, sound insulation characteristic

## 1.4. Existing housing

### 1.4.1. Typical constructions found in existing stock

#### Period - 1970

In an investigation in the beginning of the 1970's asking people on the annoyance by living noise of their neighbours the following turned out [1]:



**Table 1.3.** Annoyance and sound source in residential buildings.

Sound source	Percentage of inhabitants being annoyed or very annoyed in house erected			
	Until 1918	1919-1944	1945-1960	1960-1970
talking	17.9	22.9	28.9	35.6
radio, TV	21.7	30.2	34.5	33.7
children playing	12.7	14.8	26.2	35.6
walking	16.6	13.9	25.4	33.8

The “old” constructions, which were mainly brick work walls with floors from timber beams with parquet floor on heavy slag and with a ceiling from reed with plaster, had good sound insulation. The new constructions, however, were walls with less mass, walls with inappropriate isolation mats, concrete or brick floors with less mass and with inappropriate “floating” screed; in addition flanking inner walls with low mass reduced the sound insulation between flats.

In the investigation, the required sound insulation in sound level difference and impact sound level was defined and instructions for appropriate constructions and appropriate workmanship were published.

### Period after 1975

After 1975 the sound insulation following the new standard ÖNORM B 8115 and the instructions for correct planning and workmanship, communicated in a series of seminars and similar, improved. In particular the plans and the achieved sound insulation in the finished residential buildings were controlled by federal authorities if the buildings had been subsidized (and nearly all were subsidized). With the great number of new residential buildings constructed following the new standards, the number of people disturbed by the living noise of the neighbours was reduced.

The many types of light concrete and brick floors disappeared and 20 or 25 cm concrete floors were used combined with effective floating concrete screeds. Partitions from concrete or brick walls covered with effective linings from gypsum board on mineral wool (required with respect to the heat insulation between flats to avoid “heat theft”) ensure high sound insulation. Additionally in the last decades timber constructions for

multifamily houses with adequate sound insulation were developed and erected.

In Austria in 1970-1994, inquiries about the annoyance of people in their dwellings were performed by Statistisches Zentralamt, now Statistic Austria, in 3-year periods within the scope of carrying out a micro census. In the following years the inquiries were performed at somewhat wider intervals in 1998, 2003, 2007 and 2011. So there exists a good overview of the development of annoyance by noise in Austria in the last 4 decades [6]. Up to 1998 the annoyance could be specified in 3 degrees: very strong, strong and slight. In 2003 the rating of the annoyance was widened to 4 degrees: very strong, strong, medium and slight. By inserting the grade "medium" the share of the other grades was reduced. The annoyance is asked for day and night separately. The sources of strong and very strong annoyance are separated into road traffic noise, railway noise, aircraft noise, noise from neighbours, noise from industry and other sources. In 2003 29.1%, in 2007 38.9% and in 2011 40% were annoyed in different grades by noise of different sources. Traffic is the most important source of annoyance, although it was significantly reduced, with 62% in 2011 compared to 74% in 2003. The most important source – not induced by traffic – is the neighbours' noise, significantly higher in houses with 10 or more flats compared to smaller houses. In 2003 noise from the neighbours was the cause for annoyance in 10.5%, in 2007 in 12.7% and in 2011 in 16.5%.

In all the past years the percentage of annoyance decreased; only in the last enquiries (2007 and 2011) the percentage increased a little; that seems to be explained by the facts that many more private buildings are now erected (plans and achieved sound insulation not controlled) and traffic noise is considerably reduced and new buildings are erected in suburbs with less traffic noise so that the neighbours may be heard better.

#### *1.4.2. Typical sound insulation performance in Austrian buildings*

The following Figures 1.18 and 1.19 show the (measured) average, maximum and minimum weighted standardized sound level difference  $D_{nT,w}$  between flats in residential buildings in **Vienna** in the period between 2001 – 2010 [7]. Figure 1.19 shows the airborne sound insulation if the spectrum adaptation term C according to ISO 717-1 is considered.

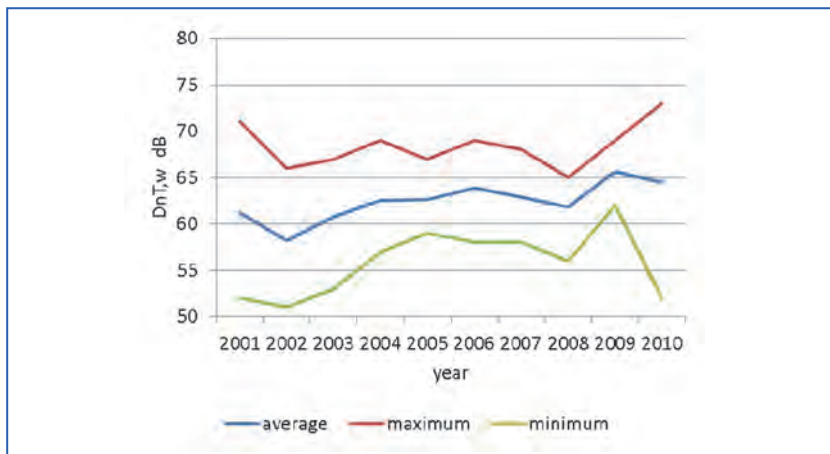


Figure 1.18.  $D_{nT,w}$  between adjacent flats.

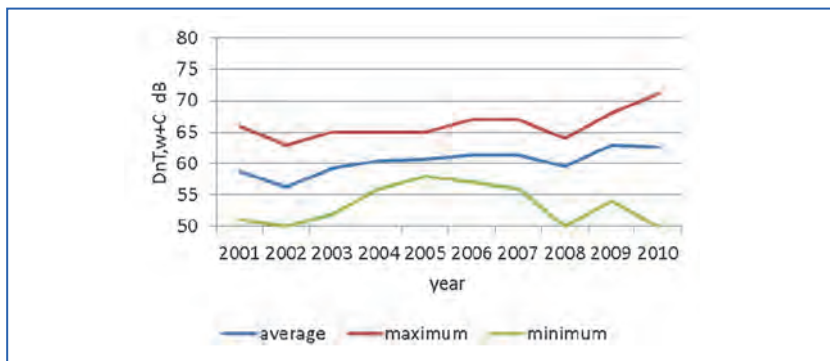


Figure 1.19.  $D_{nT,w} + C$  between adjacent flats.

In Figures 1.20 – 1.22, the (measured) average, maximum and minimum weighted standardized impact sound pressure levels  $L'_{nT,w}$  of floors between flats in residential buildings in **Vienna**, in the period between 2001 – 2010 [7], are shown. Figures 1.21 and 1.22 show the impact sound insulation if the spectrum adaptation terms  $C_1$  and  $C_{1,50-2500}$  according to ISO 717-2 are taken into account.

In the following Figures 1.23 – 1.28 the airborne and impact sound insulation ( $D_{nT,w}$  and  $L'_{nT,w}$ ) in subsidized residential buildings, in the province of **Upper-Austria**, for the period from 1990 – 2010, are shown [8].

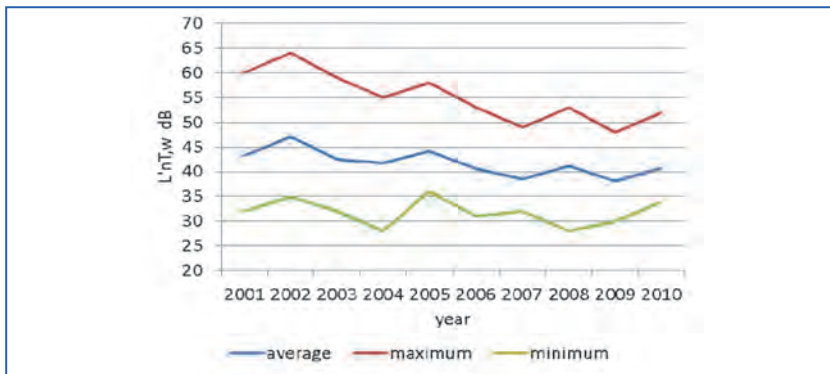


Figure 1.20.  $L'_{nT,w}$  between flats one above the other.

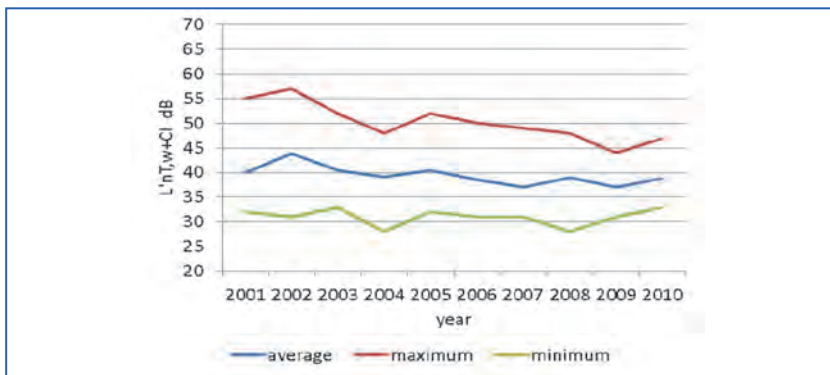


Figure 1.21.  $L'_{nT,w} + C_i$  between flats one above the other.

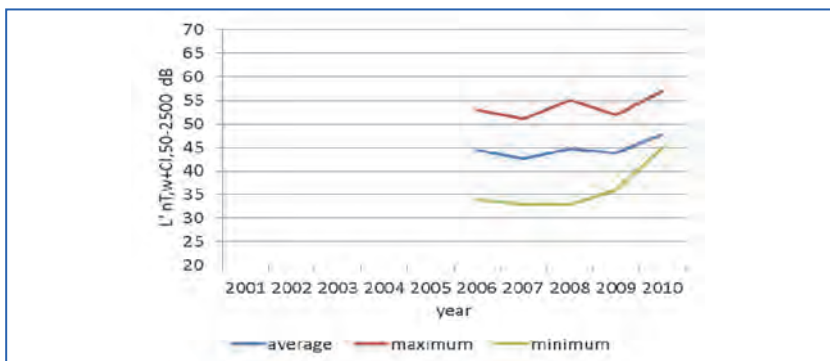


Figure 1.22.  $L'_{nT,w} + C_{i,50-2500}$  between flats one above each other.

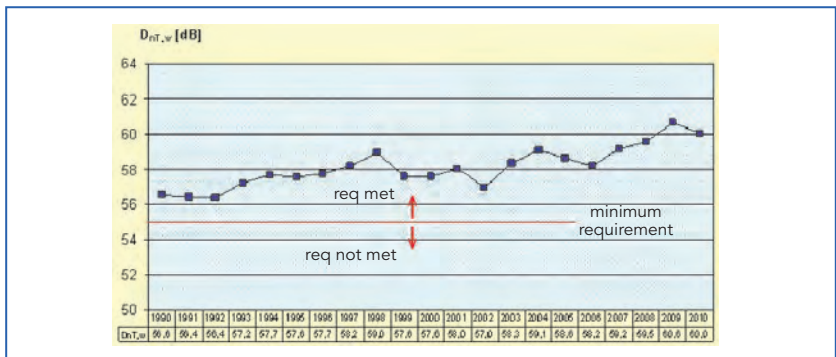


Figure 1.23. Average weighted standardized sound level difference  $D_{nT,w}$  between adjacent flats per year.

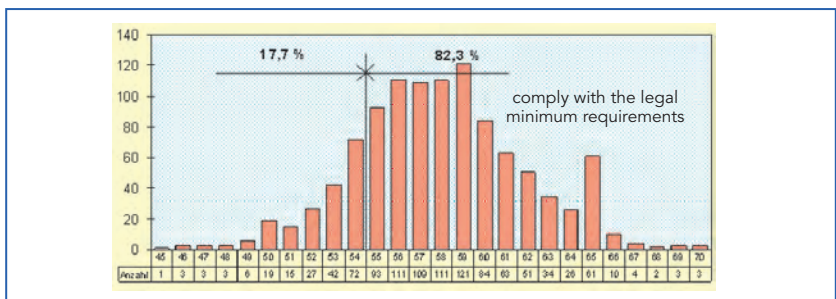


Figure 1.24. Frequency of weighted standardized sound level difference values between adjacent flats (measured during the period from 1990 – 2010).

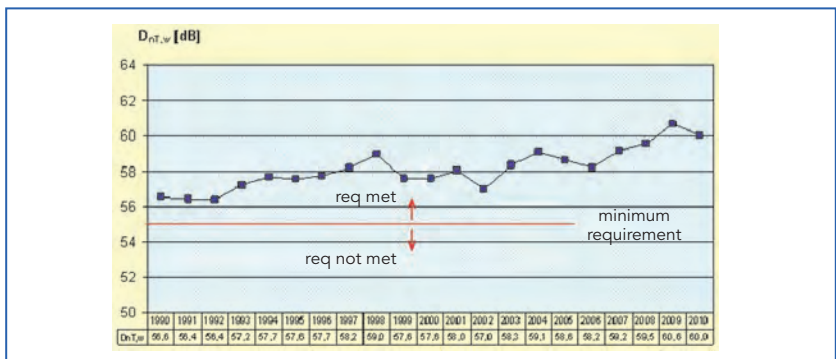


Figure 1.25. Average weighted standardized sound level difference  $D_{nT,w}$  between flats one above the other per year.

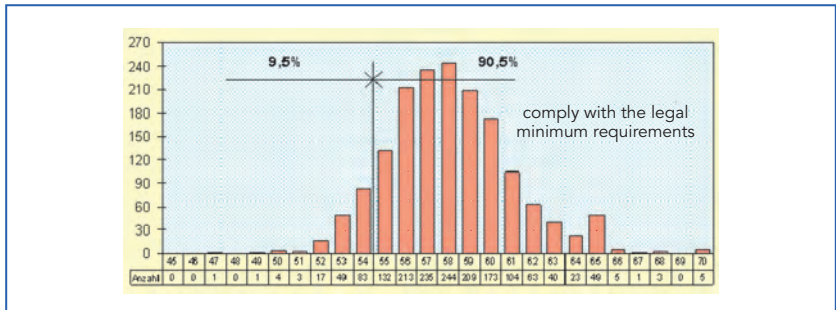


Figure 1.26. Frequency of weighted standardized sound level difference values between flats one above the other (measured during the period from 1990 – 2010).

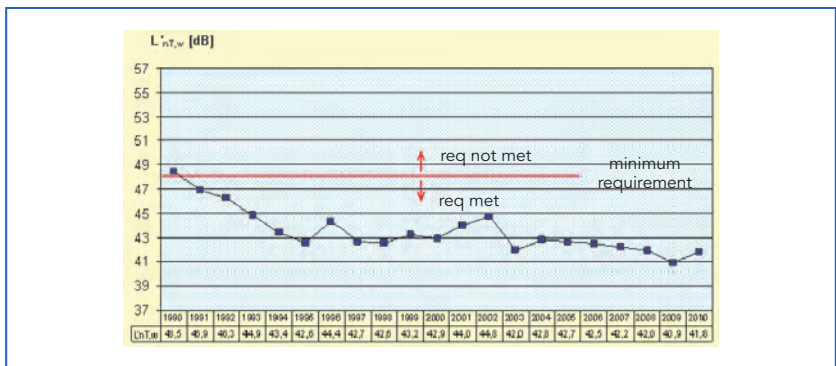


Figure 1.27. Average weighted standardized impact sound pressure level  $L'_{nT,w}$  of floors between flats per year.

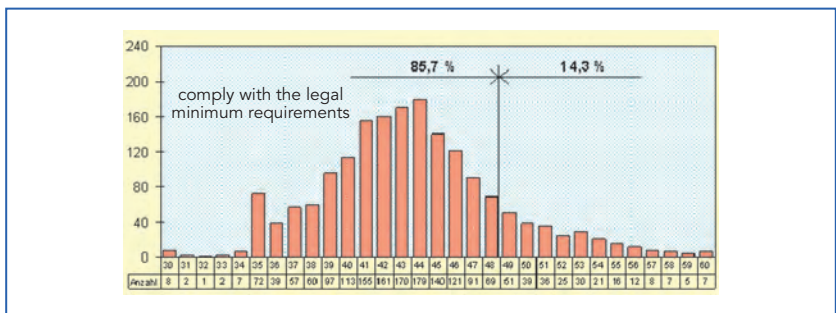


Figure 1.28. Frequency of weighted standardized impact sound pressure level values between flats one above the other (measured during the period from 1990 – 2010).

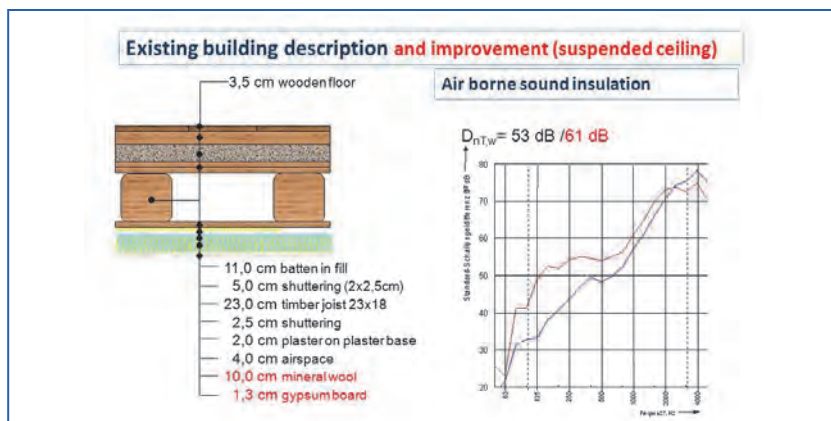
## 1.5. Methods of improving sound insulation

### Example of improvement of sound insulation in an existing building

The following data are taken from a study “Possibilities of improvement of airborne and impact sound insulation for timber floors” carried out by the department on protection of the environment of the administration of the province of Upper Austria [9].



**Figure 1.29.** Example of a residential building in Linz (capital of the province of Upper Austria), built during the first half of the 20<sup>th</sup> century, brickwork walls and timber floors.



**Figure 1.30.** Improvement of a timber joist floor, adding a suspended ceiling.

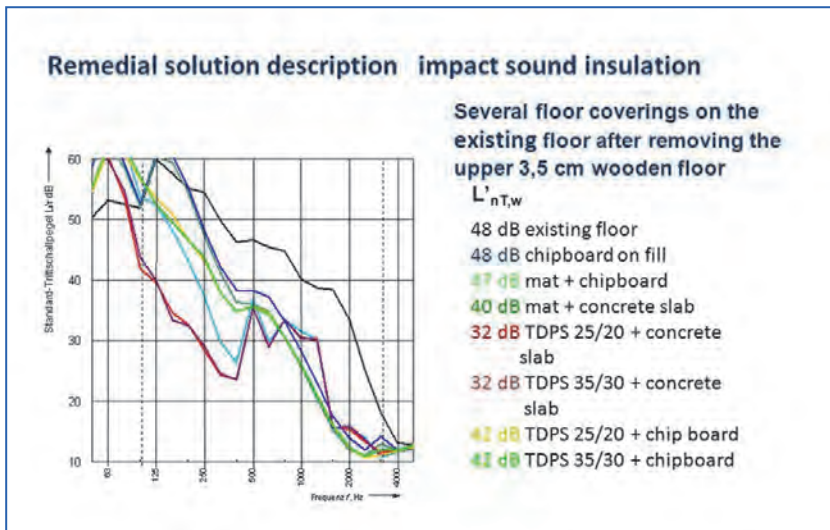


Figure 1.31. Impact sound insulation properties of a timber joist floor with different kind of floor coverings, existing upper floor covering was removed.

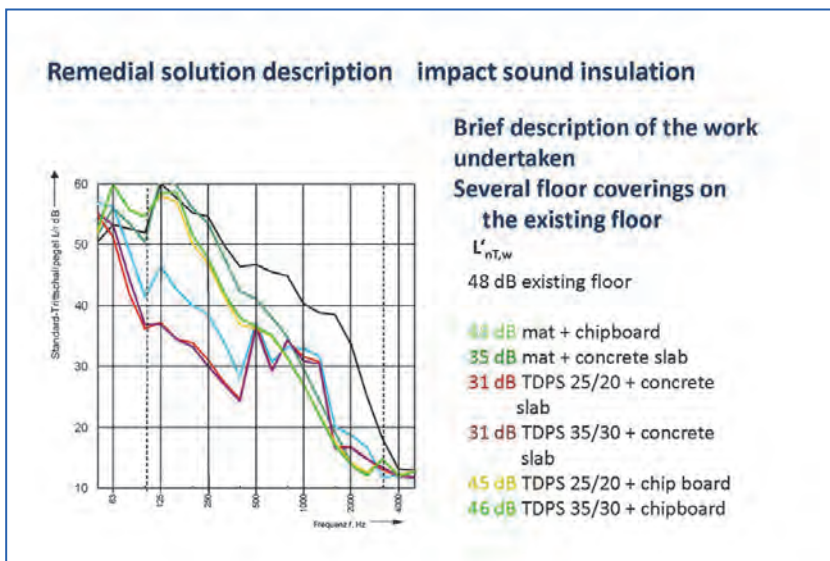
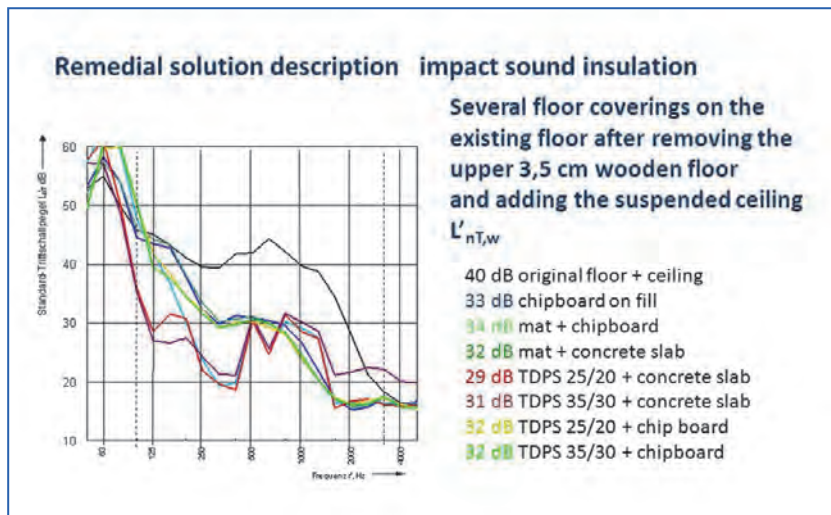


Figure 1.32. Impact sound insulation properties of a timber joist floor with different kind of floor coverings, added to the existing floor covering.





**Figure 1.33.** Impact sound insulation properties of a timber joist floor with different kind of floor coverings, added to the existing floor covering and suspended ceiling.

## 1.6. References

- [1] Bruckmayer, F. and Lang, J. (1974): Richtlinien für die Anwendung wirtschaftlicher Schallschutzmaßnahmen im Wohnungsbau (Guidelines for economic sound insulation measures in housing construction). Schriftenreihe Heft 55 Forschungsgesellschaft für Wohnen, Bauen und Planen, Wien 1974.
- [2] STATISTICS AUSTRIA, Buildings and Dwellings Censuses 1951 to 2001, Register-based Census 2011. Compiled on 4 December 2013. <http://www.statistik.at>
- [3] STATISTICS AUSTRIA, Buildings and Dwellings Censuses 1971 to 2001, Register-based Census 2011. Compiled on 4 December 2013. 1) Including other public bodies. - 2) 1991 Census: 1981 or later. - 3) 2001 Census: 1991 or later. <http://www.statistik.at>
- [4] Muellner, H., Frey, A. and Humer, C. (2008): Sound insulation properties of building elements, considering the frequency range below 100 Hz. Proceedings Euronoise Paris 08.
- [5] Muellner, H. and Plotzlin, I. (2002): The Influence of the Screw Position on the Airborne Sound Insulation of Plasterboard Walls, Proceedings Forum-Acusticum Seville 2002.

- [6] Umweltbedingungen, Umweltverhalten 2011, Ergebnisse des Mikrozensus, STATISTIK AUSTRIA [http://www.statistik.at/web\\_de/Redirect/index.htm?dDocName=071169](http://www.statistik.at/web_de/Redirect/index.htm?dDocName=071169)
- [7] Data delivered by Magistrat der Stadt Wien Magistratsabteilung 39, Bauphysiklabor, Arbeitsgebiet Schall, 2011.
- [8] Data delivered by Amt der Oberösterreichischen Landesregierung, Abteilung Umweltschutz, Gruppe Bauphysik, 2011.
- [9] Schallprojekt Tramdecke V3. Land Oberösterreich – Umwelt- und Anlagentechnik, 2004.



# Building acoustics throughout Europe

## Volume 2: Housing and construction types country by country

# 2

## Belgium

Author:  
**Bart Ingelaere**

BBRI-BART: BBRI-WTCB-CSTC  
Belgian Building Research Institute  
Avenue Pierre Holoffe 21, 1342 Limelette, Belgium  
e-mail: [bart.ingelaere@bbri.be](mailto:bart.ingelaere@bbri.be)



## CHAPTER

## 2

## Belgium

## 2.1. Design and acoustic performance

### 2.1.1. Overview of housing stock and construction sector

With a population of 11.2 million inhabitants on a surface of 30528 km<sup>2</sup>, Belgium has a population density of 361 persons per km<sup>2</sup>, one of the highest in the world.

Being the first country on the continent involved in the industrial revolution, very early a dense rail and tram connection system was built, to be completed in the 20<sup>th</sup> century with one of the densest road and motorway networks in Europe. Combined with the small size of the country, this allowed people to stay in their native villages and cities, so in contrary to most other European countries, no exodus to major cities happened. The consequence is a large number of middle sized cities all situated at close distance from each other combined with a huge urban sprawl, the very rural Ardennes in south eastern Belgium being the exception. This results in large traffic movements (and jams), far more than can be expected from the population size. Even nowadays most people only buy once in a lifetime a house and do not move when they change jobs, preferring to travel.

The dense traffic generates a lot of noise and due to the urban sprawl and huge population density, all airports are near dense population areas resulting in a lot of complaints about air traffic noise. Sound insulation is thus an important aspect in Belgian construction. As the population is so well spread over the territory, architecture is not characterised by high rise apartment complexes (very unpopular), but rather by terraced, detached and semi-detached houses with only a minor proportion of apartments which are almost all situated in small, low rise building complexes in the cities. Belgium has 3,654,338 dwellings of which 1,167,777 (32 %), are row houses 935,905 (25%) are semi-detached houses, 1,379,328 (38%) are detached houses (incl. farms, castles etc.) and only 171,328 (5%) are apartments [1]. Belgians still massively opt for the detached houses nowadays, continuing the tradition of urban sprawl (and traffic congestion): 63 % of the dwellings built after 1981 are

detached houses, 20% are semi-detached buildings, 10% are row houses and less than 7% apartments. To combat this urban sprawl, regional authorities now try to impose more dense constructions but encounter a lot of resistance. Better sound insulation should help the population to accept this denser architecture.

After a construction boom in 2007, activities fell gradually with 10% in the midst of the bank crisis in 2009 and recovered almost completely in 2011. 2012 saw again a decrease in activity with around 6% but the situation improved slightly in 2013. The main problems that construction faces nowadays, are the lack of available building plots and the more severe criteria for mortgages since the bank crisis [2].

Architecture in Belgium used to be (and still to a large extent is) almost entirely a private business: an individual client contacts an individual architect to design his private home. Only since the sixties, promoters have been building houses and apartments that are being sold after or during construction. The result is a non-homogeneous, very individual architecture and the use of many different building systems. Being a multicultural small country situated in the centre of Europe, Belgium has always been a bit the whole of Europe fitted in one small country, so building products and systems from most European countries are sold and used in construction.

Figure 2.1 shows examples of housing found across Belgium.

## 2.2. Requirements

### 2.2.1. Introduction

Belgium is a federal state and legal building requirements belong to the competence of each of the three regions. To avoid different requirements in each of these regions, building industry opted for acoustic requirements in a Belgian standard, identical and valid all over the territory. There are some subtle nuances, but the requirements in Belgian standards are almost as obligatory as requirements in laws, due to the Belgian law “on the obligatory use of good craftsmanship”. In case of dissatisfaction with the acoustic quality, suing before court will lead to a judgement based upon the criteria in the standard.

The first acoustic standard with criteria dates back from 1966 (NBN 576.40 “Criteria van de akoestische isolatie - Critères de l’isolation acoustique”), this standard was replaced by the standard NBN S01-400



*Figure 2.1. Examples of housing found across Belgium.*

in 1977 (same title). In 2008, this single standard was replaced by a series of standards: NBN S01-400 part 1 [4] (acoustic criteria for dwellings, published in 2008); NBN S01-400 part 2 (acoustic criteria for schools, published in 2013) and NBN S01-400 part 3 (acoustic criteria for non-residential buildings (still in preparation). We will limit the information below to part 1. The standard NBN S01-400-1:2008 “Akoestische criteria voor woongebouwen – Critères acoustiques pour des habitations” defines two acoustic classes:

- **“normal acoustic comfort” (NAC)** is a compromise between acoustic comfort/protection and building cost and is supposed to give satisfaction to statistically 70 % of the inhabitants;
- **“enhanced acoustic comfort” (EAC)** is supposed to give satisfaction to statistically 90 % of the inhabitants.

The information here below should be seen as a summary in which basic, but incomplete information is given. For important decisions and full information we refer to the standard which is available in Dutch and French.

### 2.2.2. Requirements for the sound insulation within the same dwelling (all building types) (\*)

Emission room within the same dwelling	Reception room within the same dwelling	Normal Acoustic Comfort (NAC)	Enhanced Acoustic Comfort (EAC)
Bedroom, kitchen, living room, toilet, bathroom (that does not belong exclusively to the reception room)	Bedroom, study room	<ul style="list-style-type: none"> <li>Airborne sound insulation: <math>D_{nT,w} \geq 35</math> dB</li> <li>Impact sound insulation without floor covering: no requirement</li> </ul>	<ul style="list-style-type: none"> <li>Airborne sound insulation: <math>D_{nT,w} \geq 43</math> dB</li> <li>Impact sound insulation without floor covering: <math>L'_{nT,w} \leq 58</math> dB</li> </ul>

(\*) All measurements should be done from the larger to the smaller room.

### 2.2.3. Requirements for the sound insulation between dwellings (\*)(\*\*)

ROW HOUSES / SEMI-DETACHED HOUSES (63 % of the building stock)			
Emission room outside the dwelling	Reception room inside the dwelling	Normal Acoustic Comfort (NAC)	Enhanced Acoustic Comfort (EAC)
Any room	Any room with the exception of a technical space or an entry hall	<ul style="list-style-type: none"> <li>Airborne sound insulation: <math>D_{nT,w} \geq 58</math> dB</li> <li>Impact sound insulation without floor covering: <math>L'_{nT,w} \leq 58</math> dB / <math>\leq 54</math> dB (***)</li> </ul>	<ul style="list-style-type: none"> <li>Airborne sound insulation: <math>D_{nT,w} \geq 62</math> dB</li> <li>Impact sound insulation without floor covering: <math>L'_{nT,w} \leq 50</math> dB</li> </ul>
APARTMENTS (only 6 % of the dwellings)			
Emission room outside the dwelling	Reception room inside the dwelling	Normal Acoustic Comfort (NAC)	Enhanced Acoustic Comfort (EAC)
Any room	Any room with the exception of a technical space or an entry hall	<ul style="list-style-type: none"> <li>Airborne sound insulation: <math>D_{nT,w} \geq 54</math> dB</li> <li>Impact sound insulation without floor covering: <math>L'_{nT,w} \leq 58</math> dB / <math>\leq 54</math> dB (***)</li> </ul>	<ul style="list-style-type: none"> <li>Airborne sound insulation: <math>D_{nT,w} \geq 58</math> dB</li> <li>Impact sound insulation without floor covering: <math>L'_{nT,w} \leq 50</math> dB</li> </ul>

(\*) All measurements should be done from the larger to the smaller room.

(\*\*) If the emission room is not a dwelling, specific requirements in function of the “possible noise charge” are given in NBN S01-400-1;

(\*\*\*) If the reception room is a bedroom, and the emission room outside the dwelling is not, then the requirement for normal acoustic comfort becomes  $L'_{nT,w} \leq 54$  dB

The standard considers *normal neighbour noise* as being less than 80 dB (A-weighted). Walking, the displacement of small furniture such as chairs and the impact of small toys are considered as *normal impact noise*.

### 2.2.4. Requirements for the façade sound insulation

The requirements of the façade sound insulation are determined in 4 steps S1 to S4 (see Figure 2.2).

S1. First the reference sound level  $L_{A,ref}$  in a measurement point at 2 m distance (2 m height above the ground surface) in front of the most exposed (future) façade pane<sup>1</sup> must be determined as well in the design phase as for evaluations of the finished building. The standard also gives precisions about the determination of  $L_{A,ref}$  [4];

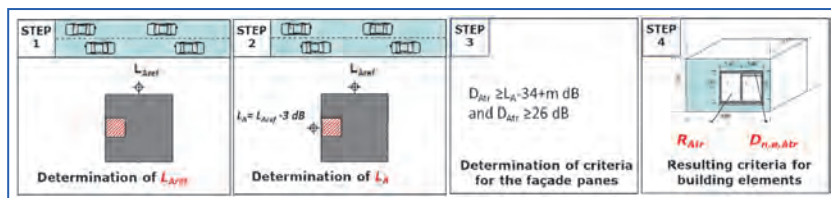


Figure 2.2. Determination of the façade requirements in 4 steps.

S2. The value  $L_A$  of the calculated sound level 2m in front of the façade pane must be derived from the reference noise level  $L_{A,ref}$  using the schemes in Figure 2.3. The same “calculation” must be applied in the design phase as well as in the evaluation of the finished building. This procedure offers more certainty for the designers and contractors and so should avoid over dimensioning of the façade sound insulation.

S3. The first requirement concerns the façade panes:

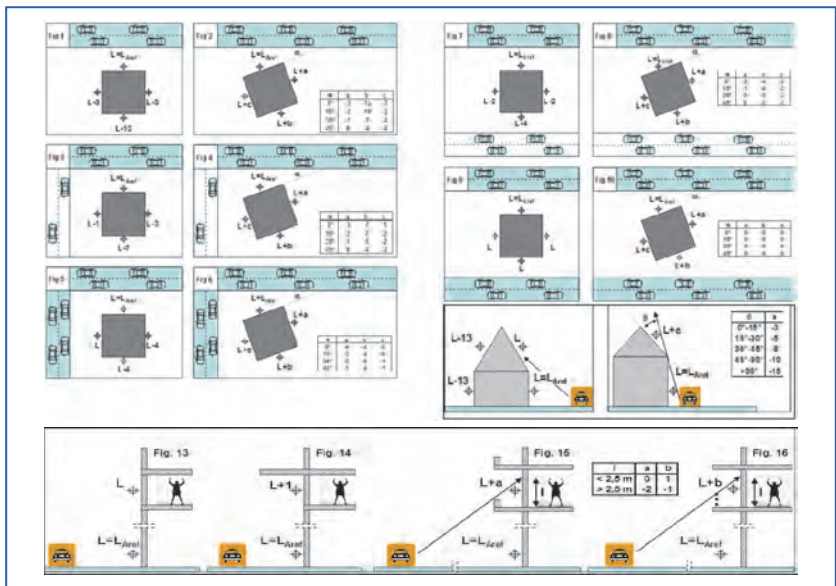
Criteria for the sound insulation $D_{Atr}$ of façade panes		
Type of room	Normal Acoustic Comfort (NAC) (*)	Enhanced Acoustic Comfort (EAC) (*)
Living room, kitchen, study room, bedroom	$D_{Atr} \geq L_A - 34 + m$ dB and $D_{Atr} \geq 26$ dB	$D_{Atr} \geq L_A - 30 + m$ dB and $D_{Atr} \geq 26$ dB
Bedrooms near airports and railways(**)	$D_{Atr} \geq L_A - 34 + m$ dB and $D_{Atr} \geq 34 + m$ dB	$D_{Atr} \geq L_A - 30 + m$ dB and $D_{Atr} \geq 34 + m$ dB

(\*)  $m = 0$  dB except  $m = 3$  dB when the room has both more than 2 façade panes containing building elements  $R_{Atr} < 48$  dB AND when  $L_A > 60$  dB in front of each façade pane.

(\*\*) In the standard, the conditions when this requirement is of application, are more developed than we can do in this small summary

<sup>1</sup> A façade pane is that part of the façade of a room that has the same orientation. Roofs are also to be considered as façade panes. Rooms can have several façade panes.





**Figure 2.3.** Obligatory derivation of the sound level  $L$  at 2 m from the façade from the reference sound level at 2 m from the most exposed façade (white streets = at least 5 dB less noise).

S4. The last type of requirement concerns the building elements. The standard gives the choice: either the design team determines the performance of each building element constituting the façade pane (using e.g. 12354 part 3), or this is not done and then the default values of the standard apply as to the table here below. The reason the standard requires this, is to be able to distinguish responsibilities if the final result does not comply with the requirements in step 3 (“is it the window, the ventilation grid or some other building element that was badly installed?”). At the same time, it gives the acoustic solution to “compose” the façade pane correctly.

Default requirements for the acoustic performance of the building elements for a certain façade pane of a living room, kitchen, study room or bedroom (with connecting details to the adjacent building element included)	
All façade elements except ventilation grids	$R_{Atr} \geq D_{Atr} + 10 \lg[3(S_{netto} + 5n)/V]$ [dB]
Ventilation grids if present	$D_{neAtr} \geq R_{Atr} + 3$ [dB]

Notes:

- $n$  = total length of ventilationgrids
- $S_{netto}$  = total surface of building elements of the façade panes that have an  $R_{Atr} < 48$  dB

### 2.2.5. The limitation of the equipment noise

There are two types of requirements:

- (1) Limitation of the excess of equipment noise relative to the background noise:

Limitation of the excess of equipment noise relative to the background noise $\Delta L_{Aeq,T} \leq$		
Room	Normal Acoustic Comfort (NAC) $\Delta L_{Aeq,T} \leq$	Enhanced Acoustic Comfort (EAC) $\Delta L_{Aeq,T} \leq$
Living room	6 dB except if $L_{Aeq,T} - k \leq 33$ dB	3 dB except if $L_{Aeq,T} - k \leq 30$ dB
Bedroom	3 dB except if $L_{Aeq,T} - k \leq 30$ dB	3 dB except if $L_{Aeq,T} - k \leq 28$ dB

- (2) The standardised equipment noise  $L_{A_{instal,nT}}$  is limited (measurement as to NBN EN ISO 10052: 2005):

$$L_{A_{instal,nT}} = 101 \lg \left( \frac{10^{L_{Aeq,1/10}} + 10^{L_{Aeq,2/10}} + 10^{L_{Aeq,3/10}}}{3} \right) - k \text{ [dB]}$$

Limitation of the equipment noise			
Situation		Normal Acoustic Comfort (NAC) $L_{A_{instal,nT}} \leq$	Enhanced Acoustic Comfort (EAC) $L_{A_{instal,nT}} \leq$
Bathroom/Toilet	Mechanical ventilation:	35 dB	30 dB
	Sanitary devices:	65 dB	60 dB
Living / Study	Mechanical ventilation	30 dB	27 dB
Kitchen	Mechanical ventilation	35 dB	30 dB
	Hood	60 dB	40 dB
Bedroom	Mechanical ventilation	27 dB	25 dB
Technical rooms with equipment for less than 10 dwellings		75 dB	75 dB
Technical rooms with equipment for 10 or more dwellings		85 dB	85 dB

### 2.2.6. Limitation of the reverberation time in the semi-public spaces of apartments (corridors, stairs)

We refer to the standard NBN S01-400-1:2008 [4] for more information on this topic.

### 2.2.7. Tolerances

To take in account the measurement precision, a tolerance of 2 dB is allowed for the airborne and impact sound measurements and 3 dB for

the façade sound insulation measurements, except if it can be shown that the original design could not meet the requirements. The standard recognizes that in some cases of retrofitting of old buildings, the requirements cannot be fulfilled because of esthetical, historical or technical reasons. A complete procedure described in the standard is to be followed in such cases (for more details, see standard chapter 10).

### 2.2.8. Classification system

The standard has only 3 classes: enhanced acoustic comfort, normal acoustic comfort, insufficient comfort. In the standard NBN S01 400-1:2008, this only allows for the classification of performances of parts of the building. It does not allow for the overall classification of the dwelling. Such a system for the overall classification of a building exists in Belgium via a private system “VALIDEO” (similar to the BREEAM approach).

## 2.3. New build housing constructions: general concepts

### 2.3.1. Introduction

The BBRI publishes Technical Notes which are followed as guides of good practice all over Belgium. In juridical cases these are often taken as “the rules of good craftsmanship” (see the law about this in the chapter about requirements) and can be seen as the complement of the acoustic standard. The text and drawings below are extracts from the technical note about acoustics and dwellings. To fit in the limited number of pages available, the text below will be restricted to 10 junctions between dwellings and no façade sound insulation nor equipment noise will be treated in the text below. The technical note –a living document as it will be also published as an e-book– is still under preparation and contains a lot more information than the few pages here below.

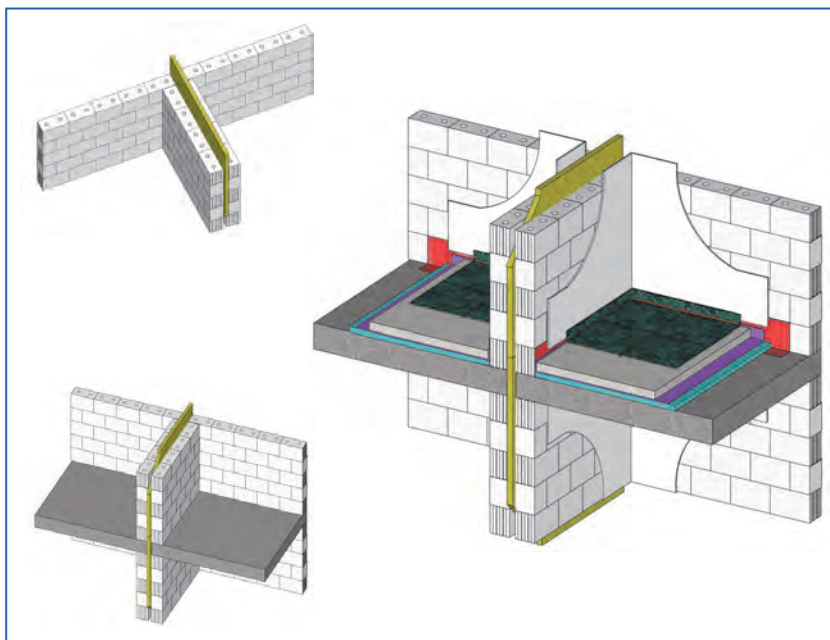
The technical note uses “building concepts”, i.e. a series of total concepts of building junctions (floor / party wall / lateral walls /...) , see Section 2.3.2.-2.3.10. *In Belgium, thermal requirements impose a minimal thermal insulation between dwellings (even between apartments), which has a serious influence on the acoustic building concepts: there needs to be some thermal insulation in the party wall or floor.* The information in the technical note goes a lot further than we can do here. As an example and only for the first 5 building concepts, we have added the main checklists accompanying these building concepts.

Checklists for the other building concepts can be given by the author on simple request.

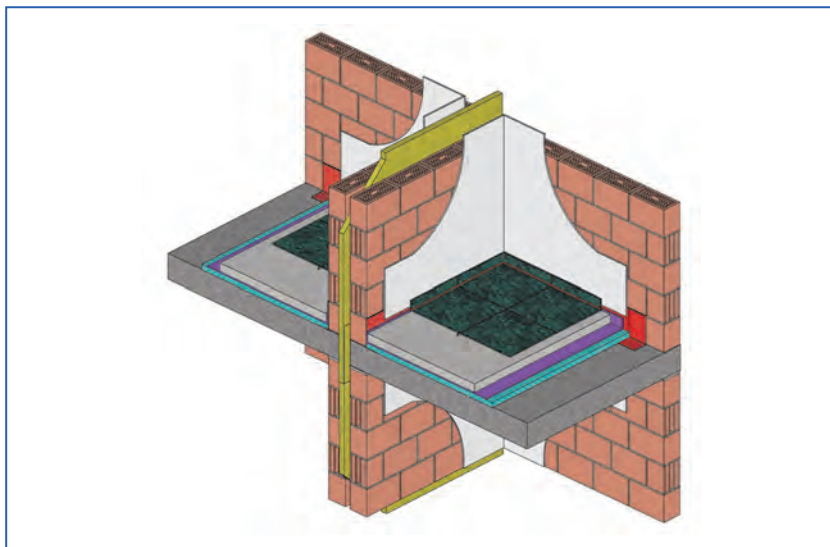


### 2.3.2 CONCEPTS 1 and 2: Building concepts with INTERRUPTED floor slabs and LOAD BEARING DOUBLE walls WITHOUT TIES as party wall

The party wall between two apartments or row houses consists of two walls separated by a cavity of at least 4 cm. In between both walls, neither connections nor ties are allowed at all. The concrete slab must bear on each of these walls but shall be interrupted in the cavity. The only exceptions are the connections at the foundation level and the roof. Special details there have to be respected so as to limit the structural transmission between both leaves to preserve the acoustic double wall behaviour of the party wall. The concept avoids all flanking transmission and very high sound insulations between two horizontally adjacent dwellings can be obtained; The system assures enhanced acoustic comfort between row houses for surface masses of the composing party walls  $\geq 150 \text{ kg/m}^2$ . Not all variants are suitable for apartment constructions. Though in the horizontal way, very high sound insulations are possible, in the vertical way, a judicious choice of surface masses for walls and floors as well as good floating floors is necessary.



**Figure 2.4.** Drawing of building concept 1 using heavy walls ( $>250 \text{ kg/m}^2$ ).



**Figure 2.5.** Building concept 2 uses semi-heavy walls (> 125 kg/m<sup>2</sup>) and needs very heavy concrete slabs (> 550 kg/m<sup>2</sup>) if used for apartment constructions.

**Checklists:**

Foundation and the lowest load bearing floor	SEMI HEAVY				HEAVY		
	Variant 1	Variant 2	Variant 3	Variant 4	Variant 1	Variant 2	Variant 3
Choice of the type of foundation and lowest load bearing floor	Choose the suitable construction in chapter 2.4.1.				Choose the suitable construction in chapter 2.4.1		
$\Delta L_w$ [dB] of the floating floor above the lowest load bearing floor $\geq$	22	22	22	22	22	22	22
<b>Higher situated load bearing floors</b>	<b>Variant 1</b>	<b>Variant 2</b>	<b>Variant 3</b>	<b>Variant 4</b>	<b>Variant 1</b>	<b>Variant 2</b>	<b>Variant 3</b>
Connections between the load bearing floors at the party wall junction	None	None	None	None	None	None	None
Should the load bearing floor be supported by its wall portion of the party wall?	Yes	Yes	Yes	Yes	Yes	Yes	Yes
Should the load bearing floor be supported by ALL the other load bearing walls?	Yes	Yes	Yes	Yes	Yes	Yes	Yes

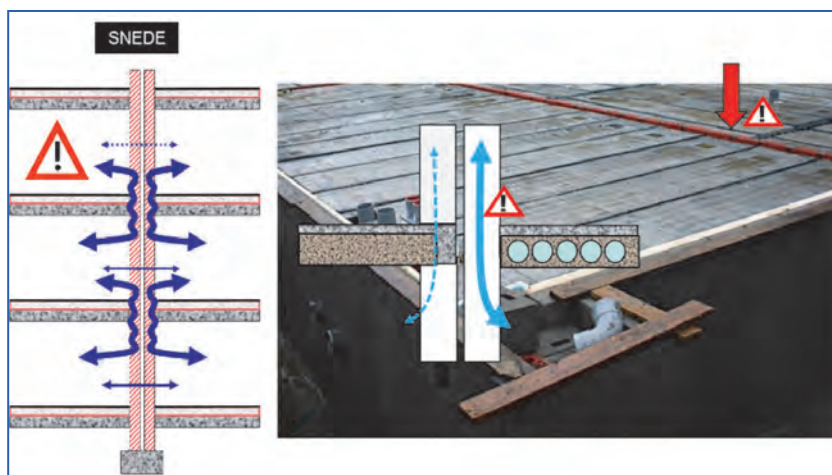
	SEMI HEAVY				HEAVY		
Higher situated load bearing floors	Variant 1	Variant 2	Variant 3	Variant 4	Variant 1	Variant 2	Variant 3
Minimal surface mass [kg/m <sup>2</sup> ] of the load bearing floor ≥	300	300	400	550	300	400	550
Minimal ΔLw [dB] of the floating floor ≥	No requir.	24	24	24	22	22	24
Minimal ΔLw [dB] of the floating when the room above a bedroom is not a bedroom ≥	No requir.	24	24	24	22	22	24
Acoustic strips	Variant 1	Variant 2	Variant 3	Variant 4	Variant 1	Variant 2	Variant 3
On top of the wall / below concrete slab	None	None	None	None	None	None	None
Below the wall / on top of the concrete slab	None	None	None	None	None	None	None
Party wall	Variant 1	Variant 2	Variant 3	Variant 4	Variant 1	Variant 2	Variant 3
Minimal surface mass m'' [kg/m <sup>2</sup> ] of wall portion 1 ≥	125	150	150	150	250	250	250
Minimal surface mass m'' [kg/m <sup>2</sup> ] of wall portion 1 ≥	125	150	150	150	250	250	250
Minimal cavity width [cm] ≥	4	4	4	4	4	4	4
Limitation of the cavity filling when using a rigid thermal insulation [cm] ≤	2	2	2	2	2	2	2
Connections between the wall portions	None	None	None	None	None	None	None
Other load bearing walls	Variant 1	Variant 2	Variant 3	Variant 4	Variant 1	Variant 2	Variant 3
Minimal surface mass m'' [kg/m <sup>2</sup> ] ≥	125	125	150	150	250	250	250
Interruption of the inner leaf of the façade wall at the junction with the cavity of the party wall	Yes	Yes	Yes	Yes	Yes	Yes	Yes
Interruption of the outer leaf of the façade wall at the junction with the cavity of the party wall	Recomm.	Recomm.	Recomm.	Recomm.	Recomm.	Recomm.	Recomm.
Façade cavity filling near party wall and floor	See chapter common details				See chapter common details		
Non load bearing walls	Variant 1	Variant 2	Variant 3	Variant 4	Variant 1	Variant 2	Variant 3
Surface mass m''	No requir.	No requir.	No requir.	No requir.	No requir.	No requir.	No requir.

	SEMI HEAVY				HEAVY		
Non load bearing walls	Variant 1	Variant 2	Variant 3	Variant 4	Variant 1	Variant 2	Variant 3
Acoustic strips below the semi-heavy walls ( $m'' < 150 \text{ kg/m}^2$ ) (this is always the case on top of the walls):	Recomm.	Recomm.	Recomm.	Recomm.	Recomm.	Recomm.	Recomm.
Acoustic class to be expected	Variant 1	Variant 2	Variant 3	Variant 4	Variant 1	Variant 2	Variant 3
APARTMENT CONSTRUCTION	Not suitable	Not suitable	(NAC)	(EAC)	Not suitable	(NAC)	(EAC)
ROW HOUSES	NAC	EAC	EAC	EAC	EAC	EAC	EAC

Note: EAC= Enhanced acoustic comfort / NAC= Normal acoustic comfort (see chapter requirements)

Common errors or risks are:

- Concept details are not entirely respected (e.g. mixing of prescriptions between different variants);
- Local connections between both walls of the party wall (mortar bridges, steel ties, continuous concrete beam, continuous floor or terraces, ...);
- Floors do not support on all load bearing walls (important vertical flanking  $F_f$ , structural flanking via foundation in the case of the party walls);



**Figure 2.6.** When precast concrete elements or concrete slabs are not supported by all load bearing walls, then important vertical flanking transmissions can occur (path  $F_f$ ).



- Bad combination of too light floor slabs and too light load bearing walls (especially for the façade walls): increases the vertical flanking transmission in apartment constructions;
- Problems with the floating floor (see chapter common details);
- Roof details or foundation details are not correctly executed or followed (see chapter common details);
- Details at the junction of the façade with the party wall or floor wrongly executed or designed (see chapter common details);
- Indirect sound transmission via mechanical ventilation systems, hoods, insufficiently acoustically attenuated ventilation grids.



*Figure 2.7. Hard connections (continuous floors, concrete beams but even small metal ties can largely reduce the sound insulation; the party wall loses its acoustic double wall behaviour and extra flanking transmission will occur.*

### **2.3.3. CONCEPT 3: Building concepts with INTERRUPTED floor slabs, ACOUSTIC STRIPS and SEMI-HEAVY (> 125 kg/m<sup>2</sup> for each wall) LOAD BEARING DOUBLE walls WITHOUT TIES as party wall**

The party wall between two apartments or row houses consists of two SEMI-HEAVY walls (each at least **125 kg/m<sup>2</sup>**, e.g. 14 cm bricks) separated by a cavity of at least 4 cm. In between both walls, neither connections nor ties are allowed at all. The concrete slab must bear on each of these walls but shall be interrupted in the cavity. The only exceptions are the connections at the foundation level and the roof for which special details have to be followed to limit the structural transmission between both leaves to preserve the acoustic double wall behaviour of the party wall.



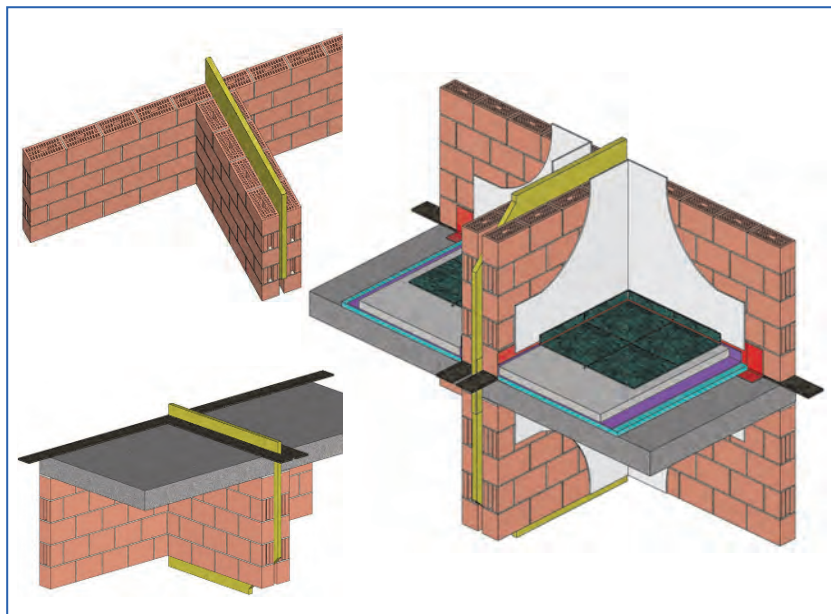


Figure 2.8. Sketchup drawings of building concept 3.

The concept avoids all flanking transmission and very high sound insulations between two **horizontally** adjacent dwellings can be obtained; the system allows for obtaining enhanced acoustic comfort between row houses. To limit the flanking transmission in the **vertical way (apartment constructions)**, acoustic strips needs to be placed between the concrete slab and ALL the load bearing walls (so not only below the party wall). The acoustic strips almost entirely eliminate the Ff and Df flanking transmission paths and allow for **the use of lighter concrete slabs**. This system is limited to max 5 floor levels. The concept is **only useful for the construction of apartments**, it is indeed not necessary to undertake such actions for the vertical flanking transmission paths for row houses.

### Checklists:

Foundation and the lowest load bearing floor	Variant 1	Variant 2	Variant 3
Choice of the type of foundation and lowest load bearing floor	Choose the suitable construction in chapter 2.4.1.		
$\Delta L_w$ [dB] of the floating floor above the lowest load bearing floor $\geq$	22	22	22



Higher situated load bearing floors	Variante 1	Variante 2	Variante 3
Connections between the load bearing floors at the party wall junction	None	None	None
Should the load bearing floor be supported by its wall portion of the party wall?	Yes	Yes	Yes
Should the load bearing floor be supported by ALL the other load bearing walls?	Yes	Yes	Yes
Minimal surface mass [kg/m <sup>2</sup> ] of the load bearing floor ≥	300	400	500
Minimal ΔLw [dB] of the floating floor ≥	24	22	22
Minimal ΔLw [dB] of the floating when the room above a bedroom is not a bedroom ≥	28	25	25
Acoustic strips	Variante 1	Variante 2	Variante 3
On top of the wall / below concrete slab	None	None	None
Below the wall / on top of the concrete slab	Yes	Yes	Yes
Party wall	Variante 1	Variante 2	Variante 3
Minimal surface mass m'' [kg/m <sup>2</sup> ] of wall portion 1 ≥	125	150	150
Minimal surface mass m'' [kg/m <sup>2</sup> ] of wall portion 2 ≥	125	150	150
Minimal cavity width [cm] ≥	4	4	4
Limitation of the cavity filling when using a rigid thermal insulation [cm] ≤	2	2	2
Connections between the wall portions	None	None	None
Other load bearing walls	Variante 1	Variante 2	Variante 3
Minimal surface mass m'' [kg/m <sup>2</sup> ] ≥	125	125	125
Interruption of the inner leaf of the façade wall at the junction with the cavity of the party wall	Yes	Yes	Yes
Interruption of the outer leaf of the façade wall at the junction with the cavity of the party wall	Recomm.	Recomm.	Recomm.
Façade cavity filling near party wall and floor	See chapter common details		
Non load bearing walls	Variante 1	Variante 2	Variante 3
Surface mass m''	No requir.	No requir.	No requir.
Acoustic strips below the semi-heavy walls (m'' < 150 kg/m <sup>2</sup> ) (this is always the case on top of the walls):	Recomm.	Recomm.	Recomm.
ACOUSTIC CLASS TO BE EXPECTED	Variante 1	Variante 2	Variante 3
APARTMENT CONSTRUCTION	NAC	NAC	EAC
ROW HOUSES	NAC	EAC	EAC

Note: EAC= Enhanced acoustic comfort / NAC= Normal acoustic comfort (see chapter requirements)

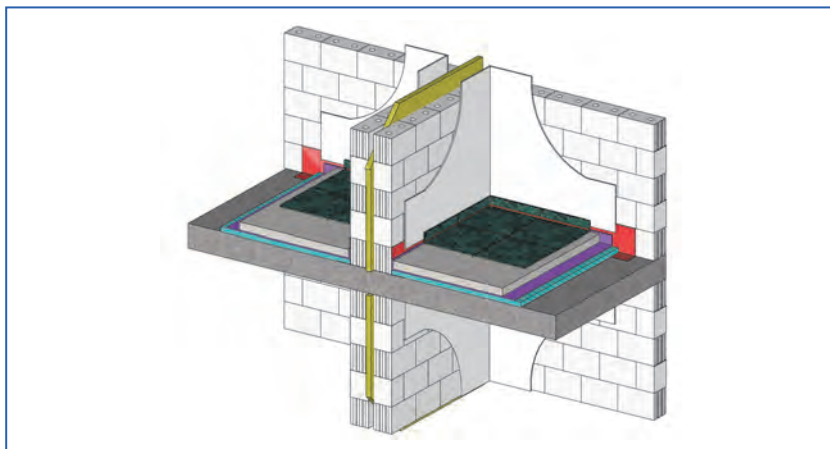


Common errors or risks are:

- A great quantity of mortar bridges connecting the brick wall and the floor slab can deteriorate the sound insulation;
- When no elastic border strip is placed against the brick wall before pouring the levelling screed, then this latter can form a “vibration bridge” between the brick wall and the concrete slab, deteriorating seriously the sound insulation.
- Similar problems as described in building concept 1.

#### 2.3.4. *CONCEPT 4: Building concepts with CONTINUOUS floor slabs HEAVY (>200 kg/m<sup>2</sup> for each wall) LOAD BEARING DOUBLE walls*

This building concept is not valid for row houses (insufficient horizontal sound insulation). The party wall between both apartments consists of a double heavy wall (each wall needs to have a surface mass superior to 250 kg/m<sup>2</sup>) with the thermal insulation in the cavity. The cavity should be larger than 3 cm. Connections between the walls are allowed as the system does not work as an acoustic double wall construction. In the vertical direction, enhanced acoustic comfort can be obtained when sufficiently heavy concrete slabs and a very efficient floating floor are used (variant 2). Special details about the connection with the roof and the façade wall have to be respected.



**Figure 2.9.** Sketchup drawing of building concept 4.

Common errors or risks are:

- This building concept is correct for the construction of apartments (requirement for the horizontal sound insulation is 4 dB lower down to only  $D_{nT,w} > 54$  dB for normal acoustic comfort). It is not suited for the construction of row houses or semi-detached houses!
- This building concept needs heavy blocks! So not suited for constructions with bricks (if applied, then a rather bad sound insulation will be the result)!
- Problems with the floating floor (see chapter common details);
- Roof details or foundation details are not correctly executed or followed (see chapter common details);
- Details at the junction of the façade with the party wall or floor wrongly executed or designed (see chapter common details);
- Indirect sound transmission via mechanical ventilation systems, hoods, insufficiently acoustically attenuated ventilation grids;

**Checklist:**

Foundation and the lowest load bearing floor	Variant 1	Variant 2
Choice of the type of foundation and lowest load bearing floor	Choose the suitable construction in chapter 2.4.1.	
$\Delta Lw$ [dB] of the floating floor above the lowest load bearing floor $\geq$	22	22
Higher situated load bearing floors	Variant 1	Variant 2
Connections between the load bearing floors at the party wall junction	None	None
Should the load bearing floor be supported by its wall portion of the party wall?	Yes	Yes
Should the load bearing floor be supported by ALL the other load bearing walls?	Yes	Yes
Minimal surface mass [kg/m <sup>2</sup> ] of the load bearing floor $\geq$	400	550
Minimal $\Delta Lw$ [dB] of the floating floor $\geq$	22	24
Minimal $\Delta Lw$ [dB] of the floating when the room above a bedroom is not a bedroom $\geq$	22	24
Acoustic strips	Variant 1	Variant 2
On top of the wall / below concrete slab	None	None
Below the wall / on top of the concrete slab	None	None



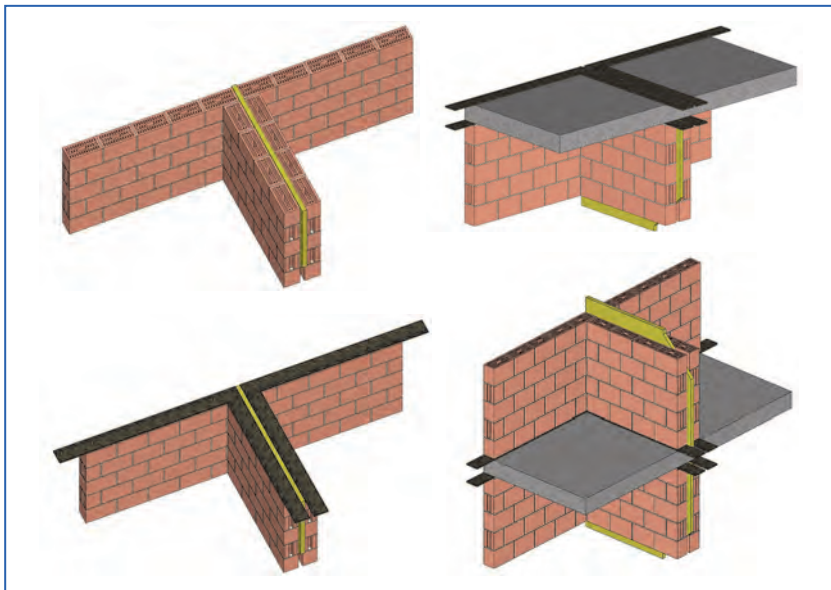
Party wall	Variante 1	Variante 2
Minimal surface mass $m''$ [kg/m <sup>2</sup> ] of wall portion 1 $\geq$	250	250
Minimal surface mass $m''$ [kg/m <sup>2</sup> ] of wall portion 1 $\geq$	250	250
Minimal cavity width [cm] $\geq$	4	4
Limitation of the cavity filling when using a rigid thermal insulation [cm] $\leq$	2	2
Connections between the wall portions	None	None
Other load bearing walls	Variante 1	Variante 2
Minimal surface mass $m''$ [kg/m <sup>2</sup> ] $\geq$	250	250
Interruption of the inner leaf of the façade wall at the junction with the cavity of the party wall	No requir.	No requir.
Interruption of the outer leaf of the façade wall at the junction with the cavity of the party wall	Recomm.	Recomm.
Façade cavity filling near party wall and floor	See chapter common details	
Non load bearing walls	Variante 1	Variante 2
Surface mass $m''$	No requir.	No requir.
Acoustic strips below the semi-heavy walls ( $m'' < 150$ kg/m <sup>2</sup> ) (this is always the case on top of the walls):	Recomm.	Recomm.
ACOUSTIC CLASS TO BE EXPECTED	Variante 1	Variante 2
APARTMENT CONSTRUCTION	NAC	NAC
ROW HOUSES	Not suitable	Not suitable

Note: EAC= Enhanced acoustic comfort / NAC= Normal acoustic comfort (see chapter requirements)

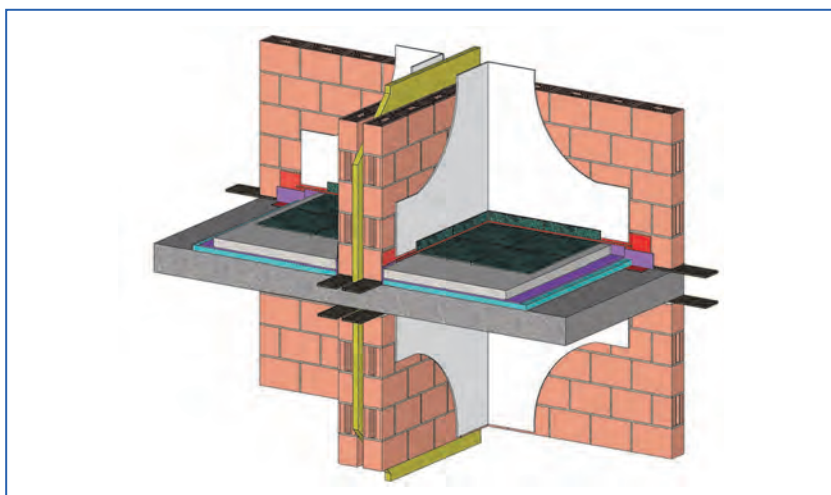
### 2.3.5. CONCEPT 5: Building concepts with CONTINUOUS floor slabs, ACOUSTIC STRIPS and SEMI- HEAVY ( $\leq 200$ kg/m<sup>2</sup> for each wall) LOAD BEARING DOUBLE walls

The party wall between two apartments or row houses consists of two SEMI-HEAVY walls (each at least **125 kg/m<sup>2</sup>**, e.g. 14 cm bricks) separated by a cavity of at least 4 cm. Between both walls, no connections nor ties are allowed at all. Special details at the junction with the roof must be respected. Specific acoustic strips are applied below and on top of all load bearing walls. This allows the double wall of the party wall to behave as an acoustic double wall even with the continuous concrete slab (from which it is separated by the acoustic strips). The sound insulation in the horizontal way is then dependent from the direct sound insulation of the party wall and the flanking transmission via the ceiling concrete slab. In the vertical direction, there is almost no flanking transmission due to the

acoustic strips. So the vertical transmission is entirely dominated by the sound insulation of the concrete slab with its floating floor.



*Figure 2.10. Sketchup drawings of building concept 5.*



*Figure 2.11. Sketchup drawing of building concept 5.*

**Checklist:**

Foundation and the lowest load bearing floor	Variant 1	Variant 2
Choice of the type of foundation and lowest load bearing floor	Choose the suitable construction in chapter 2.4.1.	
$\Delta L_w$ [dB] of the floating floor above the lowest load bearing floor $\geq$	22	24
Higher situated load bearing floors	Variant 1	Variant 2
Connections between the load bearing floors at the party wall junction	Continuous	Continuous
Should the load bearing floor be supported by its wall portion of the party wall?	Yes	Yes
Should the load bearing floor be supported by ALL the other load bearing walls?	Yes	Yes
Minimal surface mass [kg/m <sup>2</sup> ] of the load bearing floor $\geq$	400	500
Minimal $\Delta L_w$ [dB] of the floating floor $\geq$	21	24
Minimal $\Delta L_w$ [dB] of the floating when the room above a bedroom is not a bedroom $\geq$	25	24
Acoustic strips	Variant 1	Variant 2
On top of the wall / below concrete slab	Yes	Yes
Below the wall / on top of the concrete slab	Yes	Yes
Party wall	Variant 1	Variant 2
Minimal surface mass $m''$ [kg/m <sup>2</sup> ] of wall portion 1 $\geq$	125	150
Minimal surface mass $m''$ [kg/m <sup>2</sup> ] of wall portion 2 $\geq$	125	150
Minimal cavity width [cm] $\geq$	4	4
Limitation of the cavity filling when using a rigid thermal insulation [cm] $\leq$	2	2
Connections between the wall portions	None	None
Other load bearing walls	Variant 1	Variant 2
Minimal surface mass $m''$ [kg/m <sup>2</sup> ] $\geq$	125 kg/m <sup>2</sup>	125
Interruption of the inner leaf of the façade wall at the junction with the cavity of the party wall	Yes	Yes
Interruption of the outer leaf of the façade wall at the junction with the cavity of the party wall	Recommended	Recommended
Façade cavity filling near party wall and floor	See chapter common details	
Non load bearing walls	Variant 1	Variant 2
Surface mass $m''$	No requirement	No requirement
Acoustic strips below the semi-heavy walls ( $m'' < 150$ kg/m <sup>2</sup> ) (this is always the case on top of the walls):	Recommended	Recommended
ACOUSTIC CLASS TO BE EXPECTED	Variant 1	Variant 2
APARTMENT CONSTRUCTION	NAC	EAC
ROW HOUSES	RISC/NAC	EAC



Common errors or risks are:

- A great quantity of mortar bridges connecting the brick wall and the floor slab can deteriorate the sound insulation;
- When no elastic border strip is placed against the brick wall before pouring the levelling screed, then this latter can form a “vibration bridge” between the brick wall and the concrete slab, deteriorating seriously the sound insulation (see Figure 2.12);
- Junction details between ceiling/brick wall/acoustic strip not respected (see Figure 2.13);
- Problems with the floating floor (see chapter common details);
- Roof details or foundation details are not correctly executed or followed (see chapter common details);
- Details at the junction of the façade with the party wall or floor wrongly executed or designed (see chapter common details);
- Indirect sound transmission via mechanical ventilation systems, hoods, insufficiently acoustically attenuated ventilation grids.



**Figure 2.12.** Detail of concrete slab with floating floor and acoustic strip (Sonic strip, Wienerberger – CDM). It is important to put a border resilient strip before executing the levelling screed to avoid a hard contact between the concrete slab and the brick wall!





**Figure 2.13.** Detail of the acoustic strip below the concrete slab and on top of the wall. It is always important to cut the plaster at the junction between the brick wall and the concrete slab to avoid cracks (different thermal dilatation), but when using acoustic strips, it should be cut completely down to the acoustic strip and filled up with silicones to avoid a “vibration bridge”.



**Figure 2.14.** Application of acoustic strips below brick walls (party wall below) and concrete blocks (the elevator shaft). The acoustic strips (CDM, Sonic strips) have only a limited deformation (2 mm under the weight of the building, almost no creep in time).



### 2.3.6. CONCEPT 6: Building concepts with CONTINUOUS floor slabs, ACOUSTIC STRIPS and SEMI- HEAVY ( $\leq 200 \text{ kg/m}^2$ for each wall) NON-LOAD BEARING DOUBLE walls

The advantage of this system compared to concept 5 is that the acoustic strips only need to be placed at the party wall. There is less risk of execution errors with the floating floor and the acoustic strips: mortar bridges cannot short circuit the acoustic strips, there is further no need to place a border elastic strip before executing the levelling screed and the elastic interlayer of the floating floor can easily be bent towards the wall so that no execution error can happen here. The concept requires heavy concrete slabs ( $m'' > 650 \text{ kg/m}^2$ ) to limit the vertical flanking transmission, what will also have a positive effect on the horizontal flanking transmission  $F_f$  (the only path still present).

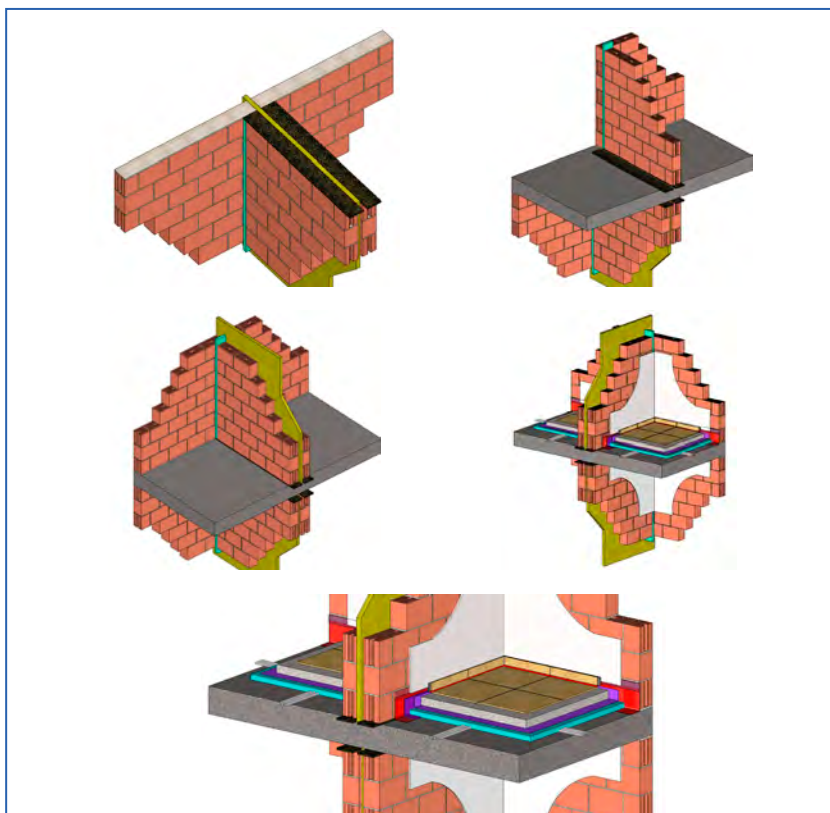
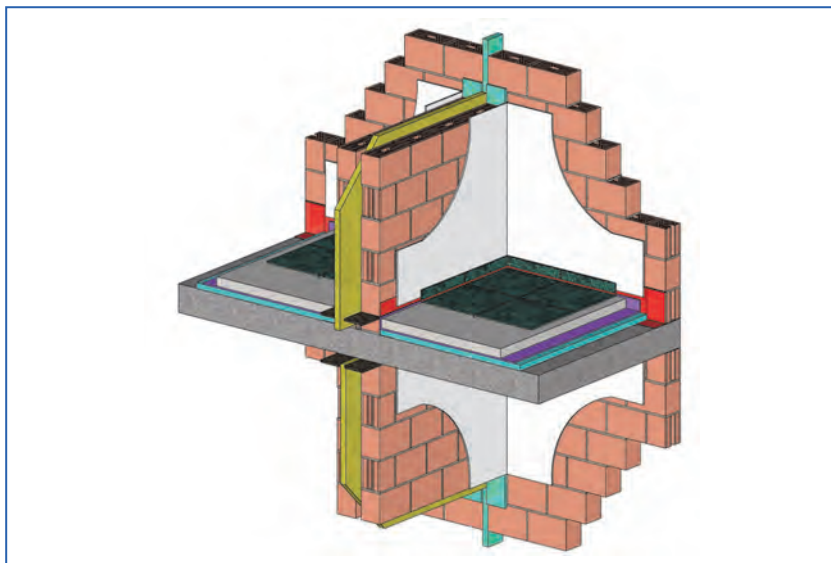


Figure 2.15. Sketchup drawings of building concept 6.



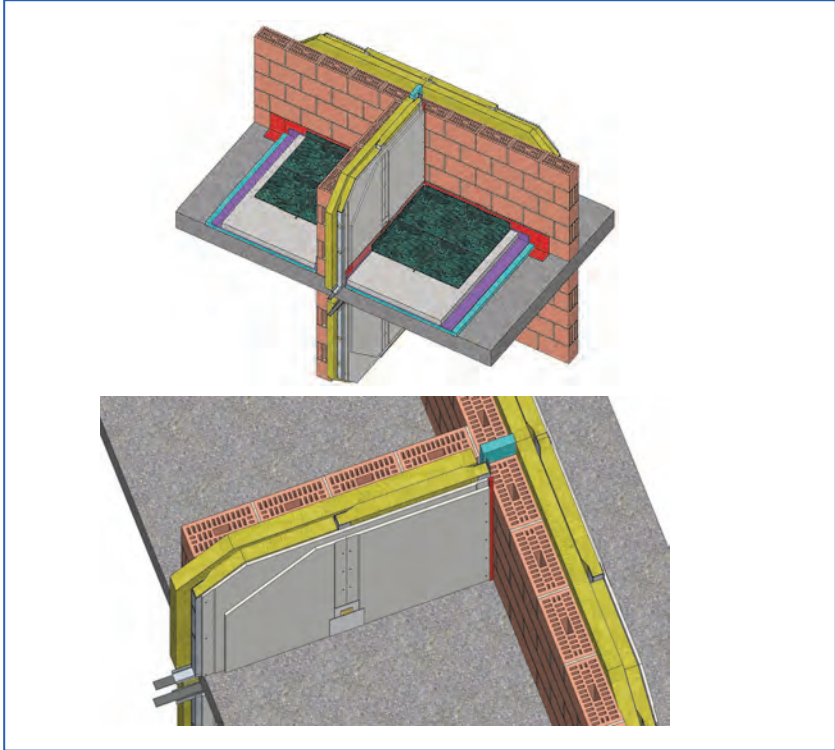
**Figure 2.16.** Sketchup drawing of building concept 6.

### **Checklist:**

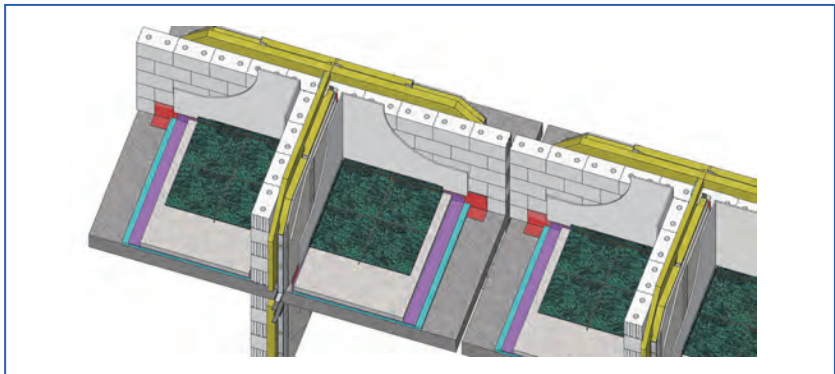
Due to space constraints, no checklist or risk warnings are given here (neither for the next building concepts).

### **2.3.7. CONCEPT 7: Building concepts with CONTINUOUS floor slabs and a party wall with a SINGLE LOAD BEARING WALL with GYPSUM BOARD LININGS**

The party wall between two apartments or row houses consists of a load bearing wall and a gypsum board lining (of at least 2 x 12.5 mm gypsum) on a separated (or vibration disconnected) metal stud frame. The cavity width between the gypsum boards and the wall should be such that the mass-spring-mass resonance falls below 50 Hz. The cavity needs to be filled with mineral wool or similar. To optimise thermal inertia of the apartment as well as to limit the vertical flanking transmission, it is interesting to have a concept such that half of the apartment party walls are stone, the other half the gypsum board lining (see figure here below). This building concept is popular as it allows for party walls with a limited width compared to the other building systems.



**Figure 2.17.** Drawings of general concept 6 with semi-heavy single load bearing wall.



**Figure 2.18.** Drawing of general concept 6 with heavy single load bearing wall.

2.3.8. **CONCEPT 8: Building concepts with CONTINUOUS floor slabs and a party wall with NON LOAD BEARING WALLS of GYPSUM BLOCKS**

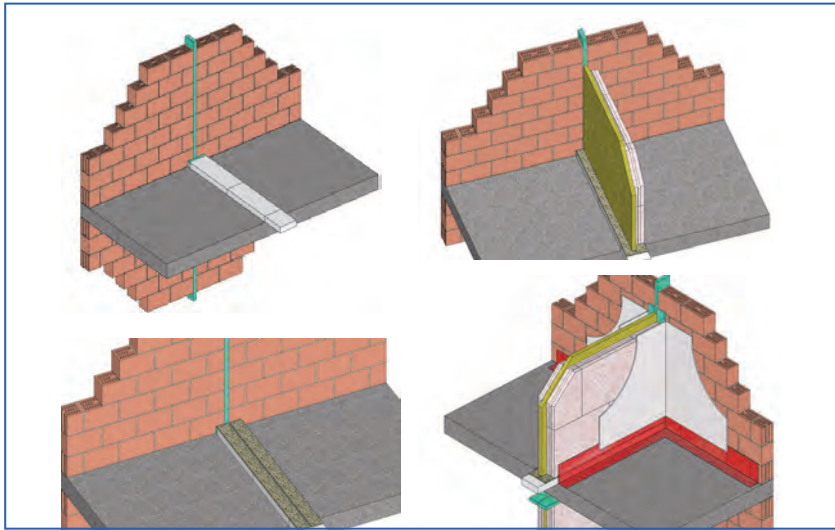


Figure 2.19. Sketchup drawings of building concept 8.

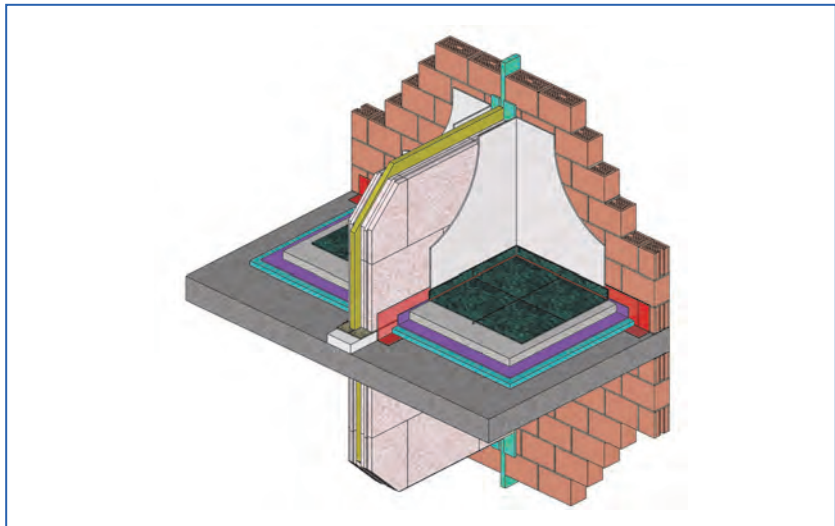


Figure 2.20. Sketchup drawing of building concept 8.



The party wall between two apartments or row houses consists of a double gypsum block party wall. The composing walls must have different thicknesses (to create compensating coincidence dips due to shifted critical frequencies). Cavity distance and surface mass of the blocks should be chosen in such a way that the mass-spring mass resonance shifts below 50 Hz. The load bearing brick wall (or other) should be interrupted at the cavity of the party wall to avoid horizontal flanking transmission. The (ceiling) concrete slab should have a surface mass of more than 650 kg/m<sup>2</sup> to limit the vertical and horizontal flanking transmission. This building concept is mainly used for the construction of apartments with a concrete frame structure. Absolute attention should be paid to the decoupling of the gypsum blocks of the surrounding structure so as to maintain the acoustic double wall behaviour of the party wall. Moreover, if not well disconnected from the floors or walls, then the badly situated critical frequency can cause most annoying noise radiation at the lower mid frequencies (equipment noise, impact noise, flanking transmission, etc.).



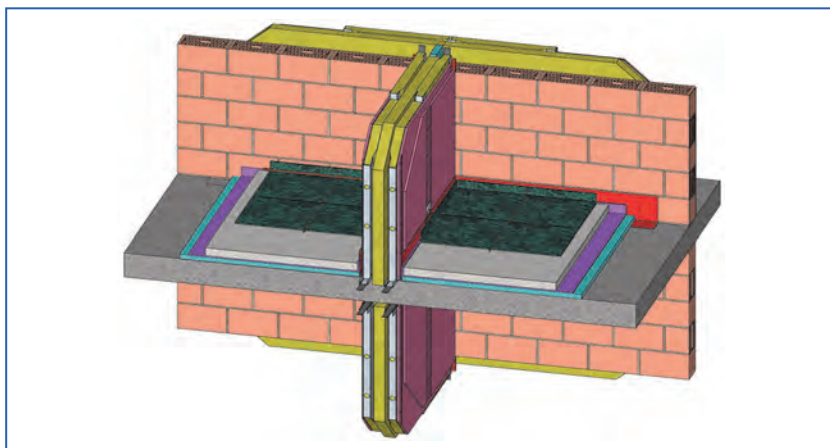
**Figure 2.21.** Gypsum block walls need to well disconnected from the surrounding structure.

### 2.3.9. CONCEPT 9: Building concepts with CONTINUOUS floor slabs and a party wall with NON LOAD BEARING WALLS of GYPSUM BOARDS

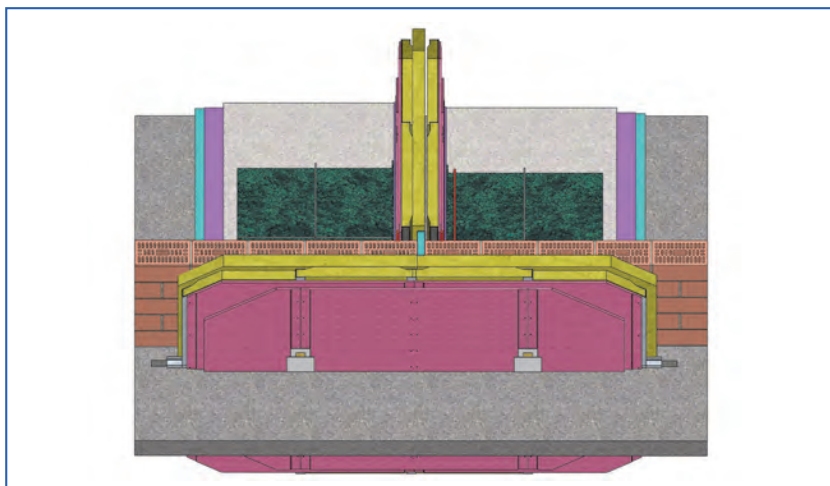
The party wall between two apartments or row houses consists of at least a double wall with separated metal stud frame and on each site a 2 x 15 mm fire resistant gypsum or 2 x 12.5 fibre reinforced cement boards with a cavity of 200 mm filled with mineral wool so as to have a mass-spring-mass resonance frequency below 50 Hz. For fire protection reasons, there can be no wholes made in this wall (e.g. for electricity plugs). If needed, extra technical linings have to be installed. The load bearing wall has to be interrupted at the cavity. The (ceiling) concrete slab should have a surface



mass of more than  $650 \text{ kg/m}^2$  to limit the vertical and horizontal flanking transmission. This building concept is not popular for new constructions in Belgium, because of the possibly complicated structure, possible complications to conciliate fire protection and the wish to have electricity plugs in the party wall. With only a double wall, there is moreover a risk of impact sound generated by cupboards mounted against the party wall.



**Figure 2.22.** Sketchup drawing of building concept 9



**Figure 2.23.** General concept: it is also necessary to put a lining before the brick wall at the side of the corridor (or of the apartment if this would be the case).



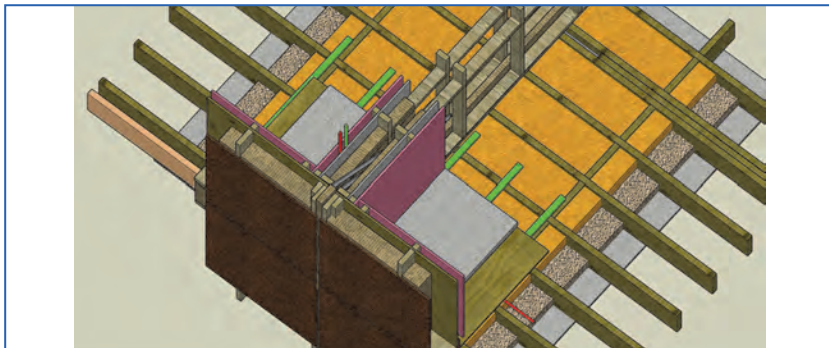
### 2.3.10. CONCEPT 10: Light weight timber frame constructions



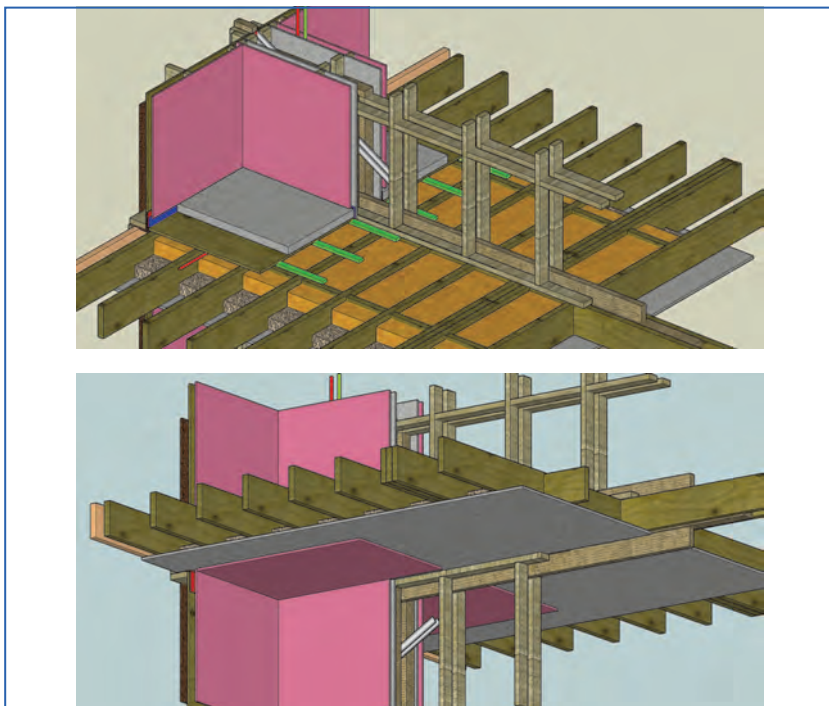
**Figure 2.24.** The newly developed party wall with improved fire and acoustic performances, are now regularly being built (prefabrication).

Light weight timber frame constructions in Belgium are popular for detached houses. In the last couple for years we see an expansion towards row houses and even small apartment constructions. Recent research in the BBRI allowed greatly improving these constructions, especially in their low frequency performance. First new party walls were developed ( $R'_{\text{living},50} > 64$  dB), in a second phase, new floors were developed ( $R_{\text{living}} > 65$  dB and  $L_{n,T,w} + C_{1,50-2500} < 48$  dB). After optimisation for non-acoustic aspects such as fire protection, building cost, airtightness, structural behaviour,... we came to the concept as shown in the figures here below. The first apartment constructions applying these designs are now being built. The new party wall is already popular for the construction of row houses (see figure just below).





**Figure 2.25.** Total concept of the LWTF construction principle for the construction of low rise apartment buildings (max 4 floors, the traditional brickwork of the exterior façade wall is not shown here).

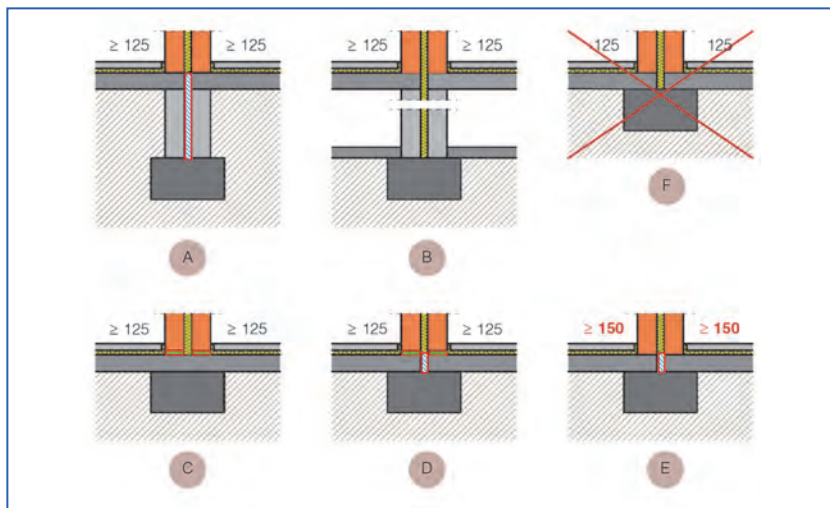


**Figure 2.26.** More views of the total concept of the LWTF construction principle for the construction of low rise apartment buildings (max 4 floors).



## 2.4. New build housing constructions: common details

### 2.4.1. Foundation details



**Figure 2.27.** Foundation details to be used to support party walls when the aim is to attain a sound insulation  $D_{nT,w} \geq 58$  dB (= normal acoustic comfort for row houses, enhanced acoustic comfort for apartments).

(Legend: 125 means wall portions with a surface mass of at least 125 kg/m<sup>2</sup>).

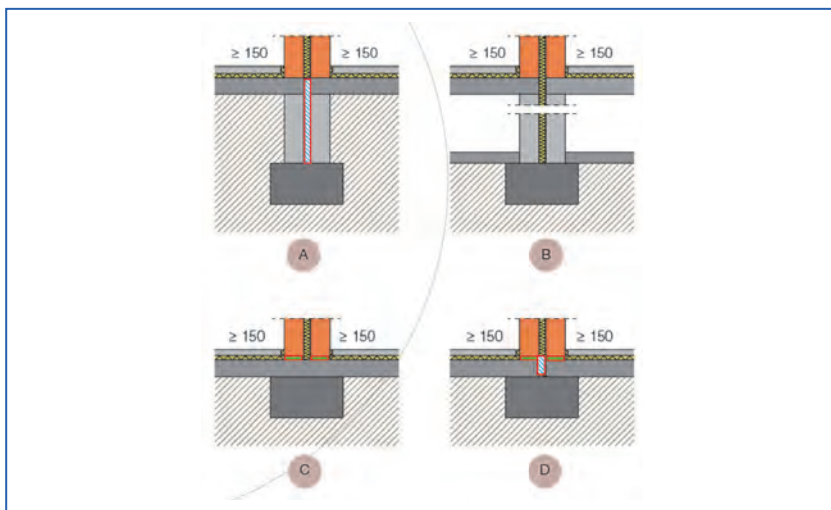
- (A) Traditional solution with deepened foundation (rigid thermal insulation PU or EPS,... between the two wall portions allowed); (B) Solution with caves; (C) Solution with a continuous foundation slab. The wall portions are built upon acoustic strips; (D) Solution with an interrupted concrete slab upon a common foundation. The use of acoustic strips under the wall portions is an extra guarantee. (F) Solution that can possibly fulfil the requirement, but that offers almost no safety margin and is therefore not advised.

### 2.4.2. Junction with the roof

Bedrooms probably need the highest acoustic protection against outdoor and neighbour noise. But due to architectural traditions, they unfortunately present the highest risk to have the worst sound insulation: very often they are under a sloped, light weight roof. The good execution of correct building details is necessary to maintain the acoustic double wall behaviour of the part wall, to avoid indirect sound transmission in the junction and to avoid a low façade sound insulation.

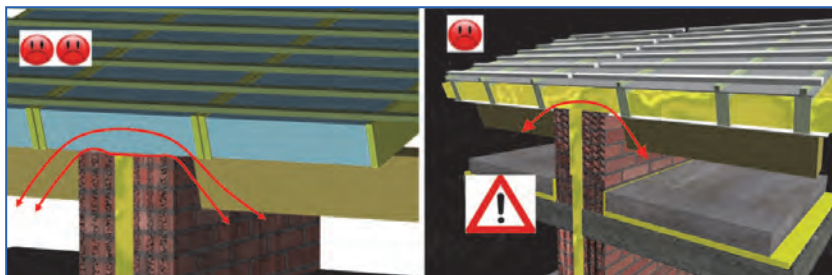


And of course all other aspects such as thermal insulation, air tightness, fire protection, etc.

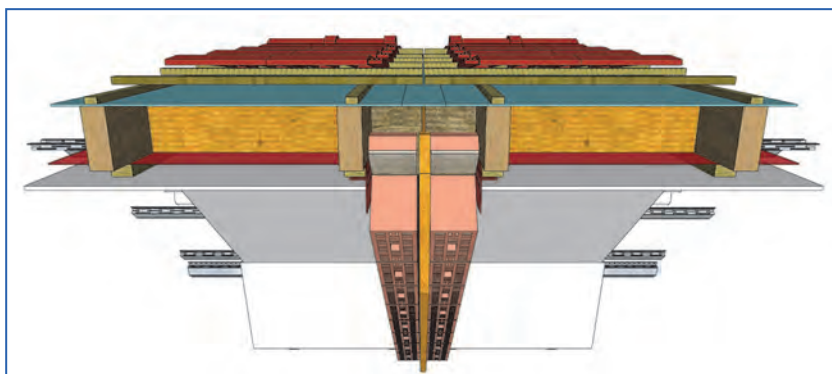


**Figure 2.28.** Foundation details to be used to support party walls when the aim is to attain a sound insulation  $D_{nT,w} \geq 62$  dB (= enhanced acoustic comfort for row houses, 4 dB better than enhanced acoustic comfort for apartments). The solutions are similar to the ones presented in the figure here above but require walls with a higher surface mass ( $>150$  kg/m<sup>2</sup>).

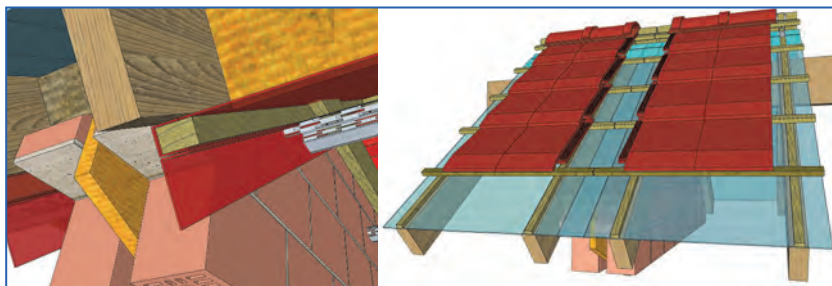
Figure 2.29 shows the incorrect building concept. Figures 2.30-2.33 gives the correct details for a low energy dwelling with a good acoustic protection. On top of the party wall, stone wool has to be added to avoid a cold bridge whilst offering a good fire protection solution. To avoid indirect sound transmission (for row houses we need to have at least  $D_{nT,w} > 58$  dB), the twills have to be mounted against the wall portions. Fixing the gypsum board ceiling on resilient channels not only allows for a very good roof façade sound insulation (if a porous, flexible thermal insulation is used), it also adds to eliminate this indirect transmission. The indirect path now crosses a gypsum board at the emission side (1), the joists at the emission side (2), then travels through the porous stone wool (3) and then again through twills (4) and gypsum boards (5) at the reception side. Details such as the air tightness foil (in red transparent colour in the drawings) are important in this robust, holistic technical approach.



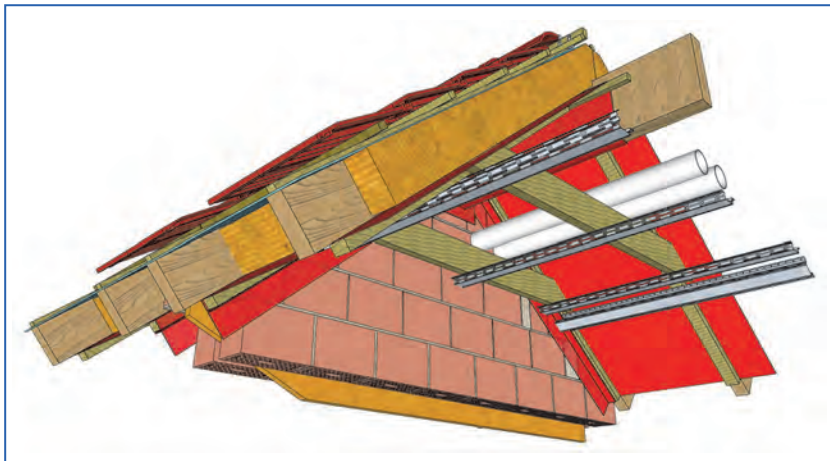
**Figure 2.29.** Incorrect building concepts. LEFT: current but wrong practice is to continue the roof construction between two apartments using sandwich panels (or similar) with light weight finishing and rigid, non-porous thermal insulation. The sound insulation between the two bedrooms can be dramatically bad. RIGHT: if the twills are not placed against the party wall, the sound insulation will not attain the required value of  $D_{nT,w} > 58$  dB for row houses.



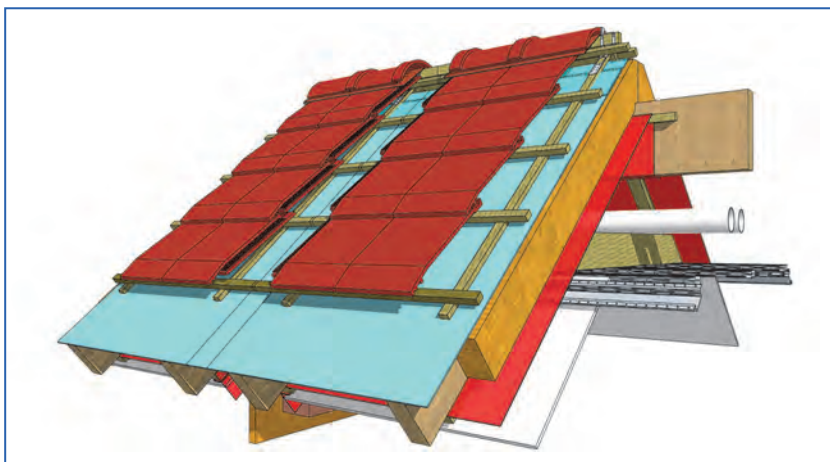
**Figure 2.30.** Correct details of the roof construction over the party wall.



**Figure 2.31.** Correct details of the roof construction over the party wall.



**Figure 2.32.** Correct details of the roof construction over the party wall.



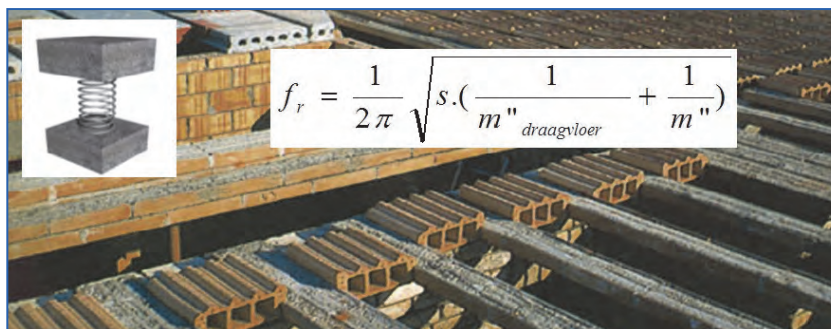
**Figure 2.33.** Correct details of the roof construction over the party wall.

### 2.4.3. Floating floors

Floating floors are extremely important for the impact sound insulation (! requirements in Belgium should be respected even on the naked screed!) AND the airborne sound insulation between dwellings. A correct concept (see drawings for the building concepts) first has all the



pipes and electric wiring in a levelling layer. After cleaning the level layer of all screws, stones or anything that can puncture the elastic foil, an elastic interlayer (see pictures of the correct execution below) is placed on top of the levelling screed, with a correct overlap and taping between the different foils. A correct placement at the borders is imperative (e.g. by upwards bending the foil against the walls). When the screed is put in place, the border foil should still be visible and not to be cut off before all the tiles are placed. Plinths are finally mounted to the walls, so that an elastic joint (silicones) remains the only connection with the floor tiles. Semi-heavy load bearing floor systems as shown in the Figure 2.34 can create serious acoustic problems when used for the construction of apartments. A sufficient thick layer of concrete ("the compression layer") should be poured on top of the above system in order to create sufficient surface mass. If lacking, then as shown in the formula for the mass-spring-mass resonance frequency, this  $f_r$  will increase! This could theoretically be compensated by a less rigid elastic interlayer, but most elastic interlayers are produced (and tested) to function with heavy load bearing floors. Conclusion: too light load bearing floors will have bad impact sound insulation and offer a bad vertical direct sound insulation. Because of its light weight, it will also allow for some important flanking transmissions!



**Figure 2.34.** Semi-heavy load-bearing floors; a risk for the impact sound insulation.



**Figure 2.35.** Correct mounting of a floating floor.



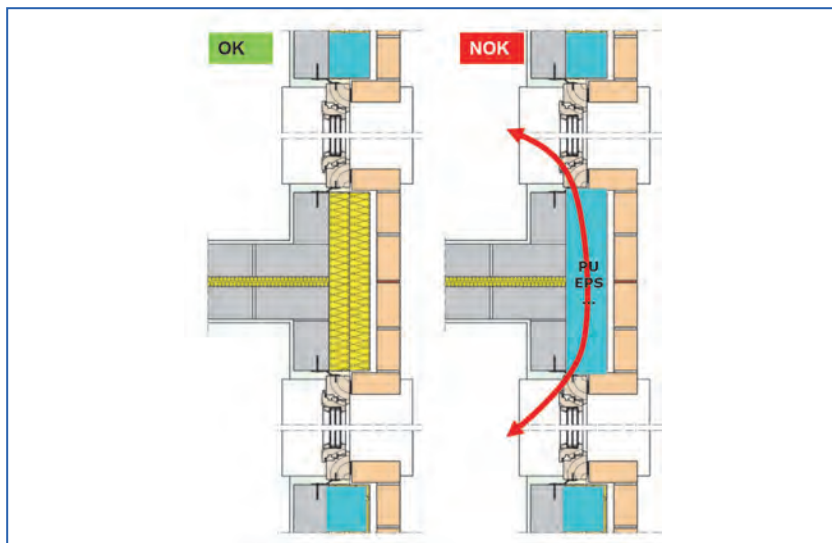
**Figure 2.36.** Bad execution of a mounting floor; sharp objects can puncture the elastic interlayer. Foils should have sufficient overlap and should be taped together. The against the wall upwards turned elastic interlayer should only be cut off after the tiling (if before, the tiles or the glue can make a hard connection with the wall, seriously diminishing the impact and airborne sound insulation of the floating floor).



#### 2.4.4. Junction between the party wall and the façade



**Figure 2.37.** The interruption of the outer façade wall will allow gaining 1 or 2 dB extra in sound insulation.

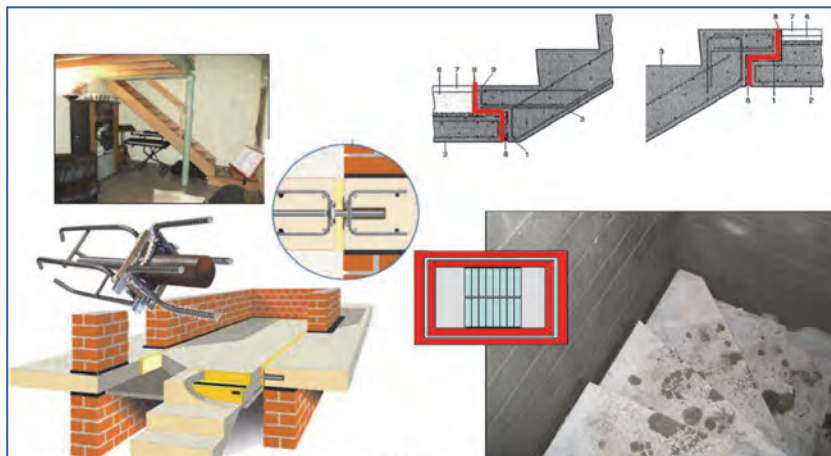


**Figure 2.38.** Inner façade walls should always be interrupted at the party wall cavity to avoid flanking transmission. For thermal reasons, often the thermal insulation in the façade is most often PU, EPS etc., i.e. a rigid thermal insulation with a non-porous structure. At the junction between two apartments or row houses, this should be replaced by mineral wool (most often by stone wool for fire protection reasons).





### 2.4.5. Stairs and staircases

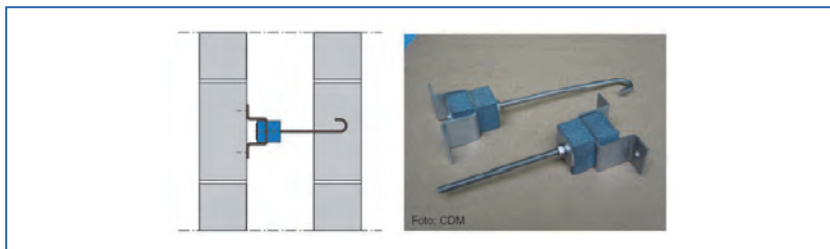


**Figure 2.39.** Solutions for stairs and staircases.  
(Commercial solutions and some pictures by Plakabeton and CDM).

The impact requirements apply for stairs and staircases. Possible solutions are the structural decoupling of the stair from the rest of the building using elastic interlayers or elastic fixations of the stairs. Commercial solutions are available to do so. Another possible solution is the construction of the staircase with walls completely disconnected from the rest of the building using a double wall system (one wall belongs to the staircase, one to the rest of the building with no structural coupling between both).

### 2.4.6. "waiting" walls

Architects can opt for a system of party walls with two load bearing walls. This is the most current practice for row houses or semi-detached houses (the major market for dwellings in Belgium). But sometimes, the first row house is being built while the adjacent construction won't be for some time. Most often, both walls are being built at the same time (so with the first construction) assuring as such some minimal thermal insulation and a protection against humidity. The second wall of course needs to be attached to the portion of the party wall that belongs to the first built house. This connection cannot be rigid for obvious acoustic reasons. Commercial systems allow doing so using elastic ties such as in the pictures here below.



**Figure 2.40.** Solutions to connect “waiting walls” to the first built house.

## 2.5. References

- [1] Statistics Belgium, Federale Overheid, Kadastrale statistiek van het ebowenpark, België en gewesten, 2013 [http://statbel.fgov.be/nl/statisieken/cijfers/economie/bouw\\_industrie/gebouwenpark](http://statbel.fgov.be/nl/statisieken/cijfers/economie/bouw_industrie/gebouwenpark)
- [2] Bouwbarometer december 2013 Daling bouwactiviteit gestopt in derde kwartaal, Vlaamse Confederatie Bouw, [www.confederatiebouw.be/nl-be/persberichten/bouwbarometer.as](http://www.confederatiebouw.be/nl-be/persberichten/bouwbarometer.as)
- [3] Akoestische verbetering van de ruwbouw door middel van ontdebeldde gemene muren voor rijwoningen en appartementen, B. Ingelaere, C. Crispin, L. De Geetere, M. Van Damme en D. Wuyts, WTCB-Dossiers 2012/2.18
- [4] NBN S01-400-1:2008 “Akoestische criteria voor woongebouwen – Critères acoustiques pour des habitations”
- [5] Acoustic design of lightweight timber frame constructions, B. Ingelaere, BBRI (Cost Action FP0702, chapter 4), [http://www.wtcb.be/homepage/index.cfm?cat=research&sub=scientific\\_publications](http://www.wtcb.be/homepage/index.cfm?cat=research&sub=scientific_publications)



# Building acoustics throughout Europe

## Volume 2: Housing and construction types country by country

# 3

## Croatia

Author:  
**Marko Horvat**

University of Zagreb, Zagreb, Croatia  
e-mail: [marko.horvat@fer.hr](mailto:marko.horvat@fer.hr)



## CHAPTER

## 3

## Croatia

### 3.1. Design and acoustic performance: Croatia

#### 3.1.1. Overview

This paragraph gives information on the overall population, building typology and quantity of housing stock. The data was taken from Croatian Bureau of Statistics (CBS) [1]. All data was taken from the latest census performed in 2011, the results of which have been processed and made available to the public recently.

The following terms are defined (as used in [1]):

- *Dwelling* – any construction entity intended for living, that consists of one or more rooms with (or without) additional service rooms (kitchen, pantry, bathroom, toilet) and has its own entrance from a hallway, staircase, yard or a street.
- *Household* – any familial or non-familial group of people (including singles) that live together and share the basic costs of living (housing, food...).

#### *General data*

Croatia has approximately 4.4 million inhabitants.

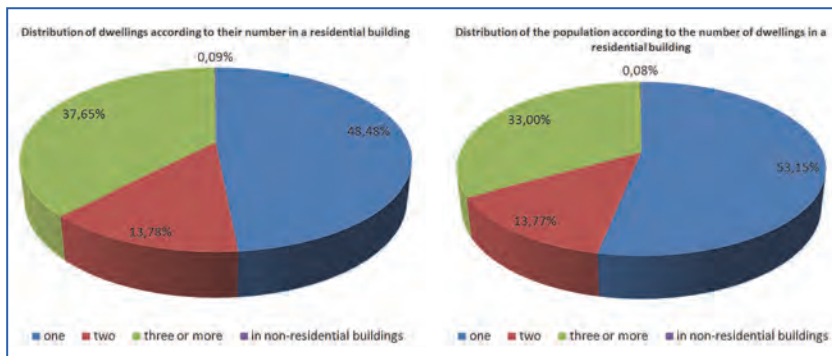
The entire residential building stock in Croatia consists of approximately 1.50 million inhabited dwellings with a total of approximately 121 million square meters, which gives the average floor area of a dwelling in Croatia of 81 m<sup>2</sup>.

The total number of households in Croatia is approximately 1.52 million.

In Croatia there are no large cities (over 1 million people). Therefore, any city in Croatia with a population of more than 100,000 people is referred to as large. There are four such cities in Croatia: Zagreb (790 thousand), Split (178 thousand), Rijeka (129 thousand) and Osijek (108 thousand).

#### *Detailed data*

The following paragraphs provide more detailed information.



**Figure 3.1.** Distribution of dwellings and the population according to the number of dwellings in residential buildings.

The charts shown in Figure 3.1 show the distribution of dwellings according to their number in a residential building and the percentage of the population living in each category of dwellings. As shown, approximately 60 % of all the dwellings are located in buildings with only one or two dwellings. The distribution of the population living in different categories of dwellings follows the distribution of the dwellings themselves, as can be seen in Figure 3.1.

Almost 50 percent of all dwellings are located in residential buildings that contain a single dwelling, i.e. single family houses.

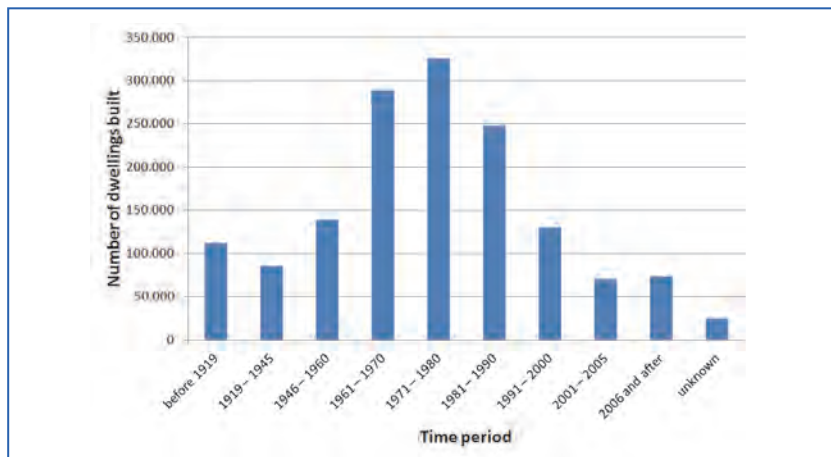
If a residential building contains two dwellings, it is in most cases a family house intended to be occupied by two generations of the same family and it is designed and built as two independent dwellings (in most cases, each dwelling occupies one storey). Another possibility is a duplex house, i.e. two family houses attached to each other by a central separating wall.

The category of residential buildings with three or more dwellings is not clarified further in statistical reports [1]. Nevertheless, the distinction can be made between small buildings such as row houses and the so-called urban villas and large multi-storey buildings.

Figure 3.2 shows the intensity of construction of dwellings in different time periods. The number of built dwellings is by far the highest in the 1970s, and the whole 30-year period between 1960 and 1990 is characterized with increased construction activity. The 1970s and 1980s could be referred to as the golden age, in the sense that practically anyone who wanted to resolve his/her housing situation could have done



so much easier than nowadays. This was the direct result of the economical situation and politics at that time, which in many ways went in favour of the people trying to procure their first dwelling.



**Figure 3.2.** Construction intensity in different time periods.

The 1990s were marked with political turmoil, the resulting Homeland war and the period of recovery, all of which basically reduced new construction down to a minimum.

In the 2000s another construction boom took place, but not as large as in the previous periods. Increased construction activity was oriented towards completing the reconstruction of the dwellings that were damaged/destroyed during the war (mostly family houses), but even more towards constructing new dwellings, mostly in urban areas (large residential buildings).

The economical crisis that started in 2008 has again reduced construction activity, as well as the dynamics of the entire real estate market, resulting in a large number of new dwellings that are still waiting to be sold (by certain unofficial estimates, 20.000 dwellings in Zagreb alone, 40.000 in the entire country).

The charts shown in Figure 3.3 show the distribution of dwellings and of the population according to the number of households that share a common dwelling. The overwhelming majority of dwellings are occupied by only one household, whereas the other listed options are only marginally present in Croatian society.

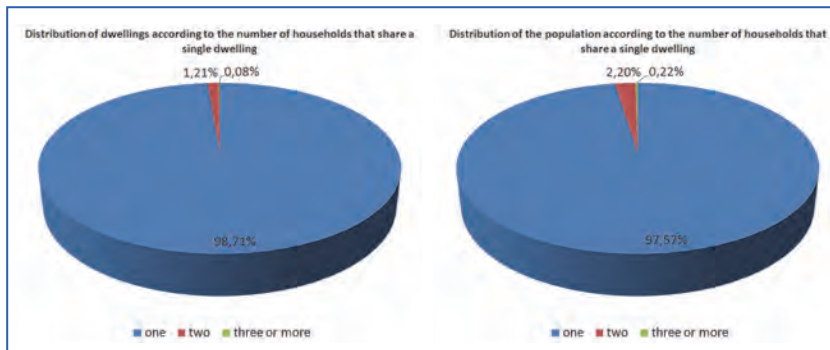


Figure 3.3. Distribution of dwellings and the population according to the number of households that share a dwelling.

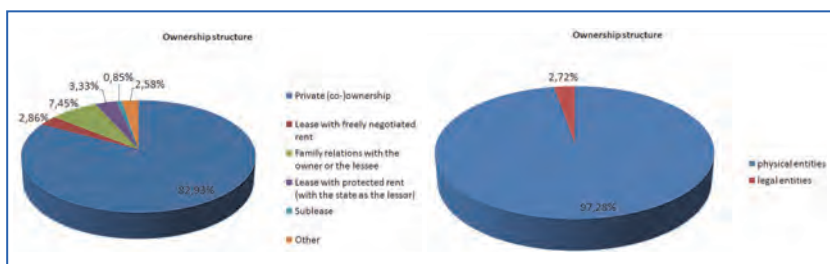
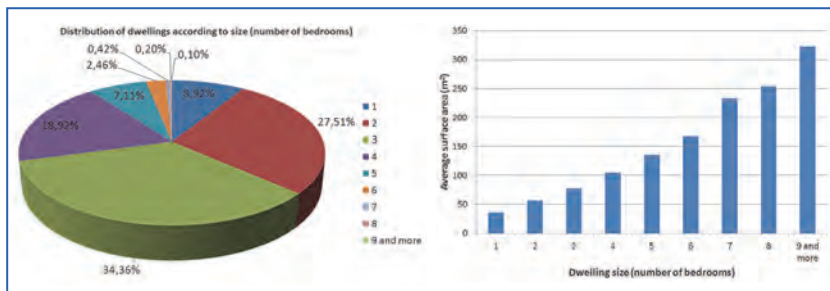


Figure 3.4. Distribution of dwellings according to ownership.

Figure 3.4 shows the distribution of dwellings according to ownership. In Croatian society there is a strong sense of necessity of owning one’s own dwelling, which is clearly supported by statistical data, showing that over 80 percent of the dwellings are privately owned. The concept of leasing a dwelling is not widely accepted. Within the category of leasing there are two major subgroups. The first one includes leases given by private lessors, where the rent is freely negotiated between the lessor and the lessee. The second one represents leases given by the state, usually intended for socially endangered, defenders in the Homeland war and other categories, in which case the rent is fixed (protected) and is usually significantly lower than on the open lease market.

The chart on the right reveals that the vast majority of dwellings is owned by physical entities, while the percentage of dwellings owned by legal entities is marginal.



**Figure 3.5.** Distribution and the average surface area of dwellings according to their size

Finally, Figure 3.5 shows how dwellings are distributed according to their size, i.e. the number of bedrooms. It can be observed that the most common sizes (1- to 4-bedroom dwellings) cover about 90 percent of the total number of dwellings. The percentage of larger dwellings is marginal by comparison. Moreover, 2-bedroom and 3-bedroom apartments are the prevailing types of dwellings in Croatia, holding about 60 percent of the total number of dwellings. Due to the limited financial strength of the majority of Croatian citizens, reasonable-size dwellings (1- to 3-bedroom) are built to meet the demands of the real estate market. Larger dwellings are not built often and they are more likely to be found in older residential buildings (mostly pre-WW2).

The chart on the right shows the average surface area of dwellings dependant on their size. For the most common types, i.e. 1-, 2- and 3-bedroom dwelling, the average surface area is 36, 56 and 78 m<sup>2</sup>, respectively.

### 3.1.2. The legislation in building acoustics

There are no laws or regulations in Croatia that stipulate mandatory measurements of sound insulation in dwellings. Such measurements are demanded only in the process of technical inspection of businesses oriented to entertainment, such as café-bars, clubs, etc.

The criteria by which the sound insulation is evaluated as (un)satisfactory in a given situation are contained in the HRN U.J6.201 bylaw [2], which has been inherited directly from the old Yugoslav JUS.U.J6.201 standard, adopted in 1982 and revised in 1989.

The HRN U.J6.201 has actually been withdrawn in 2008, after numerous warnings given by the Croatian Standards Institute to competent ministries to make an adequate replacement before the withdrawal. To this day no



such replacement has been made. Nevertheless, this particular bylaw is still used due to the fact that the occurrence of the so-called legal vacuum is not permitted, i.e. at any given time there has to be a document one can refer to and use until a suitable replacement is made, even when the old document is withdrawn, as is the case here.

Current requirements on airborne and impact sound insulation for residential and residential-office buildings are given in Table 3.1 as an excerpt from the relevant bylaw [2]. Regardless of the nomenclature used in the table, the stated values refer to in-situ measurements.

**Table 3.1.** Current requirements for airborne and impact sound insulation for dwellings in Croatia. The parameter  $L_{wmax}$  is equal to  $L_{n,w}$ .

No.	The function of the building element	$R_{wmin}$ (dB)	$L_{wmax}$ (dB)
A	Residential and residential-office buildings		
A.1	The wall between two dwellings; The wall without doors between the room in the dwelling and the common stairway (hallway); The wall between the dwelling and the elevator shaft	52	–
A.2	The wall(s) with doors between the dwelling rooms in the dwelling and the common stairway (hallway) - $D_{wmin}$	52	–
A.3	The wall between the dwelling and the garage	57	–
A.4	The wall between the dwelling and a room of other purpose (office space, a store, common room for house council meetings, common room for garbage disposal, etc.)	55	–
A.5	The wall between dwellings in a twin object, row houses, etc.	52	–
A.6	The wall between the dwelling and noisy rooms (service or business)	57	–
A.7	The wall between the dwelling and very noisy rooms	reduce noise level in the dwelling to permissible values (see Table 3.3)	
A.8	The floor between any rooms in two different dwellings; The floor in the dwelling, above a cellar, common storage rooms, entrance spaces, etc.	52	68

No.	The function of the building element	$R_{wmin}$ (dB)	$L_{wmax}$ (dB)
A.9	The floor in the dwelling, above the rooms of other purpose (office spaces, stores, common rooms for house council meetings, common rooms for garbage disposal, common pantries or drying rooms, etc.)	57	68
A.10	The ceiling in the dwelling, below the rooms of other purpose (office spaces, stores, common rooms for house council meetings, common rooms for garbage disposal, common pantries or drying rooms, etc.)	57	58
A.11	The floor in the dwelling, above the garage	57	68
A.12	The ceiling in the dwelling, below the lodge or a terrace of another dwelling; The floor of a hallway and the steps and landings of a stairway	–	68
A.13	The ceiling in the dwelling, below a common terrace	–	63
A.14	The floor in the dwelling, above noisy (service or office) rooms	57	68
A.15	The floor of a noisy room towards the dwellings above and next to it	–	48
A.16	The ceiling in the dwelling, below noisy (service or office) rooms	57	48
A.17	The floor or ceiling between the dwelling and very noisy rooms	reduce noise level in the dwelling to permissible values (see Table 3.3)	

- *Noisy (service or business) rooms* – rooms in which the equivalent noise level is between 70 and 85 dBA, measured in any three 15-minute intervals during the day or night.
- *Very noisy rooms* – rooms in which the equivalent noise level is higher or equal to 85 dBA, measured in any three 15-minute intervals during the day or night.

For calculation of single-number quantities, only the values in third octave bands from 100 Hz to 3150 Hz are used. Spectrum adaptation terms are calculated as well.

Maximum permissible indoor equivalent noise levels  $L_{RAeq}$  (with the doors and windows closed) are given in Table 3.2, as stipulated in [3].

**Table 3.2.** Maximum permissible indoor equivalent noise levels in Croatia

Zone	Purpose	Maximum permissible equivalent noise levels $L_{RAeq}$ (dBA)	
		Day	Night
1	Rest, recuperation and healing	30	25
2	Dwelling	35	25
3	Mixed; mostly dwelling	35	25
4	Mixed; mostly business with dwelling	40	30
5	Industry, storage, service	40	30

All new sources of noise introduced into the environment (both inside and outside the building) must not increase the existing noise level in dwellings and shall be treated accordingly to meet this requirement.

Noise in dwellings that originates from service equipment in the building (water supply, power supply, HVAC equipment, elevators, washing machines, waste disposal systems, motorized doors, etc.) shall not exceed the maximum standardized noise levels  $L_{RAFmax,nT}$  listed in Table 3.3, as stipulated in [3].

**Table 3.3.** Maximum permissible standardized noise levels in dwellings in Croatia, originating from service equipment

Temporal characteristics of noise	Maximum permissible standardized noise levels $L_{RAFmax,nT}$ (dBA)
Constant or intermittent noise (heating, pumps, etc.)	25
Short-term or fluctuating noise (elevators, toilet flush, etc.)	30

### 3.1.3. Building constructions used in dwellings – new-build

#### Typical constructions

Heavy constructions are preferred and widely used in construction of residential buildings in Croatia. Lightweight constructions are found mostly within dwellings, as separating walls between rooms inside a dwelling. Lightweight timber floors are not used at all, although they can

sometimes be found in family houses or weekend houses (converted from old family houses), but mostly as an aesthetic touch.

The most common constructions are listed below.

## Walls

Facade walls are constructed as:

- a) solid reinforced concrete walls (thickness  $d = 20$  cm)
- b) block-brick walls ( $d = 25$  or  $30$  cm); as an anti-earthquake measure, horizontal and vertical reinforcements are made of reinforced concrete or dedicated building blocks, in the corners of the structure and at the junctions of load-bearing walls and slabs (Figure 3.6)
- c) reinforced concrete skeleton filled with block bricks ( $d = 25$  cm)

The appearance of the constructions described under b) and c) is basically the same, but they differ significantly from the engineering point of view. In construction c) the reinforced concrete columns and beams are the load-bearing elements, while the bricks serve only as the filling. On the other hand, construction b) is based on brick walls as load-bearing elements, while the concrete reinforcements are implemented to enhance structural integrity of the building, but are not designed to function as load-bearing columns and beams, as in c).



**Figure 3.6.** Anti-earthquake reinforcements done properly (left) and improperly (right).

The use of anti-earthquake reinforcements is common, although in many older (and, sadly, new ones as well) buildings they are improperly implemented because all the bricks at the edges of a brick section (where they meet with concrete reinforcement) are aligned vertically, and they must not be. In this



manner, the bond between a wall section and the reinforcement is actually weakened, and that compromises the structural integrity of the building.

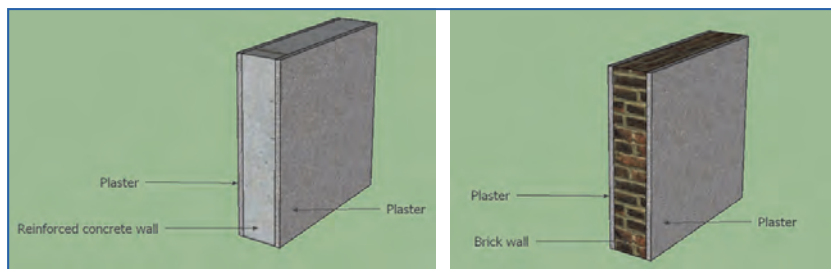
Based on the responses to a questionnaire sent out to the companies in Croatia that deal with noise and building acoustics, **the most common party wall designs** (between dwellings and between a dwelling and a hallway/staircase/elevator shaft) they encounter in multi-dwelling buildings are the following:

- solid reinforced concrete walls ( $d = 20$  cm)
- block-brick walls ( $d = 25$  to 30 cm)
- solid-brick walls ( $d = 25$  cm)

According to the same questionnaire, typical values for **airborne sound insulation of party walls** measured in-situ are  $R_w' = 52 - 56$  dB.

Prefabricated constructions are used as well, mostly as thin prefabricated concrete plates, paired and bonded together at a specified distance, leaving a cavity between them to be filled in-situ with lightweight concrete.

In most cases, walls are plastered with 1.5 to 3 cm thick plaster. Gypsum, lime-gypsum and lime-cement plasters are used, depending on the application, see Figure 3.7. Alternatively, solid reinforced concrete walls can only be laid with thin finishing and painted, provided that the planking used in the construction process was smooth enough and that the concrete was properly consolidated.



*Figure 3.7. The most common party wall designs.*

## Floors

Heavyweight floors are generally used. In most cases, floors are constructed as solid reinforced concrete slabs, as shown in Figure 3.8. In smaller buildings, mostly single-family houses, brick-based floors are used



as well, as shown in Figure 3.8 as well. Prefabricated concrete slabs are also used, manufactured as thin concrete panels with the necessary reinforcement, which are then finished in-situ to their full thickness.

At present, partition floors are constructed as floating floors, with a typical layout shown in Figure 3.9. Based on the responses to a questionnaire sent out to the companies in Croatia that deal with noise and building acoustics, **the most common floor design** they encounter in multi-dwelling buildings is the following:

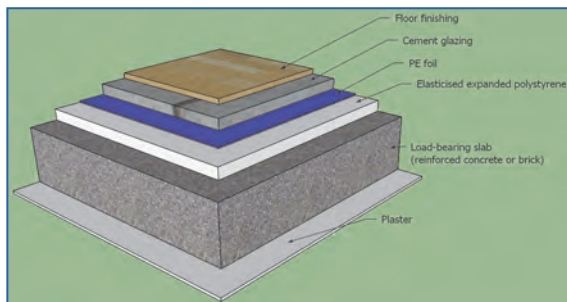
- the load-bearing element - reinforced concrete slab 16 to 20 cm thick
- 2-4 cm of elasticised expanded polystyrene - laid on top of the slab; two layers are laid if there are installations built into the floor
- protective PE foil
- 4 – 5,5 cm of cement glazing - usually reinforced with thin steel or plastic fibres
- finishing; ceramic tiles or parquet are the most common
- from below, the slab is laid with 1-2 cm of plaster or the surface is smoothed with 0,5 cm of appropriate material and then painted



**Figure 3.8.** *The most common floor slab designs: reinforced concrete (left) and brick system (right).*

According to the same questionnaire, typical values for **airborne sound insulation of floors** measured in-situ are  $R_w' = 55 - 60$  dB.

Unfortunately, the data on sound insulation properties of residential buildings and building elements used in dwellings is scarce, as the measurements of sound insulation in dwellings is not mandatory and are done only in case of a complaint. As a result, only the typical values on airborne sound insulation were available to the author, as collected from the before-mentioned questionnaire.



**Figure 3.9.** Typical cross-section of a modern floor construction.

### *Typical errors in design and workmanship*

This section lists some of the most common errors that occur in the design process or during construction.

#### **Design errors**

- Mirror layout of the installations (pipes, electrical installations, etc.) on a wall, e.g. electrical sockets put at the exact same spot on both sides of the wall, resulting in significantly reduced thickness of the wall
- No floating floor; finishing applied directly onto the load-bearing slab
- Rigid connection of the stairway to the party wall
- No separation of the floating floor between rooms
- Single-layered resilient layer in the floating floor interrupted by laying pipes that are not properly protected later, thus creating acoustic bridges

#### **Workmanship errors**

- Vertical joints between bricks not properly filled
- Contact between the floating floor and the rest of the structure
  - Separating band not applied consistently
  - Floor finishing (or bordering) in contact with walls or doorsteps
  - Resilient material of the floating floor damaged
  - Baseboard that covers the joint between a floor and a wall in direct contact with both the wall and the floor finishing

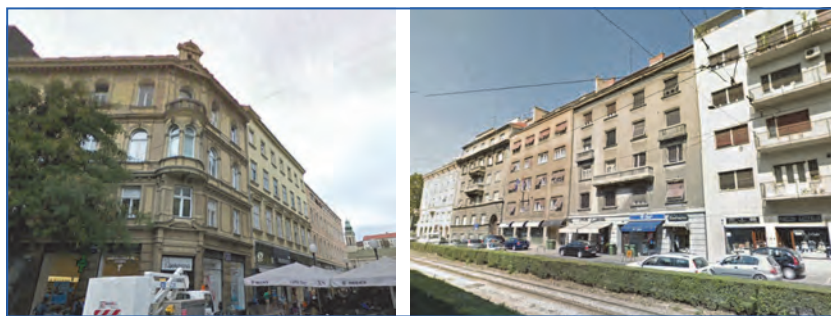


### 3.1.4. Existing housing

As shown in previous sections, the majority of population in Croatia lives in one- or two-dwelling buildings, i.e. single family houses or duplex houses. The available statistical data [1] refers to the third category of buildings residential buildings with three or more dwellings, which can be broken down further to small buildings such as row houses and urban villas and large multi-storey buildings.

Large residential buildings with more than 10 apartments have been built since the 19<sup>th</sup> century, but especially after the end of the Second World War. Their design has been changing over the years.

Old residential buildings built in the period before WW2 were located in old parts of the cities, in accordance with the layout of the streets. To save space, these buildings were attached to each other by separating walls. However, each building was built independent of the adjacent buildings, so these separating walls were never shared. The height was usually limited to three or four storeys. However, the height of a single storey was significantly larger than it is today, usually around 4 meters, whereas the most common ceiling heights today are found between 2.60 – 2.70 meters. Figure 3.10 shows an example of the outside appearance of such buildings.



**Figure 3.10.** Residential buildings built before the Second World War: the 19<sup>th</sup> century design (left) and the design used between two world wars (right).

In the era between 1945-1990, typical communist architecture similar to the one found in all countries of Eastern Europe set the way of designing and construction of large residential buildings. In a desire to provide as many dwellings as possible on the least possible area, residential skyscrapers with 15 storeys or more were quite common. Examples of this design are shown in Figure 3.11.





**Figure 3.11.** Residential buildings built in the communist era (1945 -1990): typical design in the 1950s (upper left) and the 1960s (upper right), a monster building built in mid 1970s (lower left), and the design used in 1980s (lower right).

Starting in the 1980s, however, and continuing in the 1990s and 2000s, the design of large residential buildings has changed dramatically, returning to smaller buildings with (typically) four storeys. As the surface area required for building the housing for a given number of people was thereby enlarged, the cities have extended their limits to areas previously used for agriculture or even industry. An example of a typical modern-day building design is given in Figure 3.12.

A type of residential building whose popularity has increased in the 2000s is the so-called urban villa, which is basically a small residential building with 4-6 dwellings, with usually 2-3 dwellings per storey. The reason for its popularity is the fact that they are small enough to be built on a land plot intended for a single-family house, because their floor area is usually not much bigger than the one of a single family house. This is sometimes done even by the owners of such houses themselves, who bring down their old single-family house and build a new building, in which they

usually keep an apartment for themselves. Moreover, they are usually built in suburban areas and as such, they provide living conditions in a pleasant environment, which is an ever-increasing requirement. An example of such a building is shown in Figure 3.12.

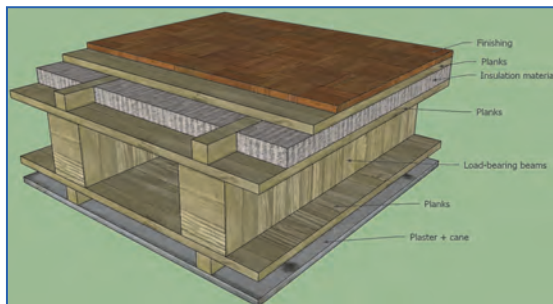
Row houses seem to be more popular in the coastal region, as well as in parts of certain cities (including Zagreb), where they replaced small single family houses built for the working class in the post WW2 time. However, the land plots these houses were built on were narrow, so the only way to gain more usable floor space was to attach the houses and build a row structure.



**Figure 3.12.** Modern-day residential buildings: typical design (upper left), a small urban villa (right).

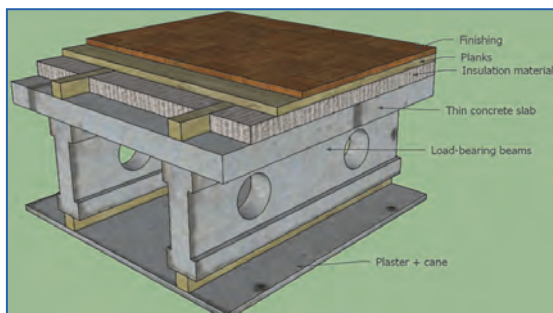
As for specific construction used in the past, facade walls were often built of solid bricks as double walls with an empty cavity between them, with the same bricks also used to join them, in order to meet the structural integrity demands. This way of construction was quite common for family houses and smaller residential buildings.

In old buildings built in pre-WW2 time, timber floors were widely used. The load-bearing construction consisted of wooden beams, on top of which a layer of planks was set (alternatively a thin concrete slab, but rarely in pre-WW2 time). Then a layer of material used for both thermal and sound insulation was laid on the planks, in most cases sand or construction waste. A second layer of planks was then laid over that and, finally, the finishing, usually parquet. On the bottom side, a layer of wooden boards was usually mounted, below which a thin layer of cane was hung as a basis for the ceiling finishing (usually plaster). A sketch of this construction is shown in Figure 3.13.



**Figure 3.13.** Floor construction used in pre-WW2 buildings

After WW2, this construction has been modified by replacing wooden beams with prefabricated ones made of concrete, on top of which the floor structure (usually a thin concrete slab) was mounted. A sketch of this construction is shown in Figure 3.14.



**Figure 3.14.** Floor construction used in buildings built in the 1950s and 1960s.

Since there is no (and has not been) a government or some other entity in Croatia that would systematically collect data on sound insulation, no data is available on the constructions used in the past.

### 3.2. References

- [1] [www.dzs.hr](http://www.dzs.hr), last accessed on 12 November 2013.
- [2] HRN U.J6.201:1989 – “Technical requirements for designing and constructing of buildings”.
- [3] “Pravilnik o najvišim dopuštenim razinama buke u sredini u kojoj ljudi rade i borave” (NN 145/2004) – “Regulations on the maximum permissible noise levels in work areas and dwellings”.



# Building acoustics throughout Europe

## Volume 2: Housing and construction types country by country

# 4

## Czech Republic

Author:  
**Jiri Novacek**

Czech Technical University, Prague, Czech Republic  
e-mail: [jjiri.novacek@fsv.cvut.cz](mailto:jjiri.novacek@fsv.cvut.cz)

© COST Office and authors (2014)

The responsibility and copyright of each chapter belongs to the author(s). When quoting, it is mandatory to make proper reference to the book and/or the authors of the quoted chapter. Permission from copyright holder is required in case of reproducing contents of images, diagrams, tables or other material from other copyright holders.



## CHAPTER

## 4

## Czech Republic

## 4.1. Design and acoustic performance: Czech Republic

### 4.1.1. Overview of housing stock

The population of the Czech Republic is approximately 10.5 million people. The total housing stock is shown in following table [7].

*Table 4.1. Housing stock in the Czech Republic (total).*

Housing stock*	Number of dwellings	%
<b>Total Housing (inhabited)</b>	<b>4 104 635</b>	<b>100</b>
Apartment buildings	2 257 978	55
Family houses	1 795 065	44
Others	51 592	1

\* data from the last census in 2011 (actual).

Most dwellings are from the period 1961-1990, as given in Table 4.2 [7]. During this period, the majority of residential buildings were built using precast concrete technology.

*Table 4.2. Housing stock according to the period of construction or reconstruction.*

Period of construction or reconstruction	Number of dwellings (inhabited)	
	Apartment buildings (in thousands)	Family houses (in thousands)
before 1920	141.2	226.7
1920-1945	207.1	318.7
1946-1960	232.9	130.1
1961-1990	1 340.6	666.8
1991-2000	147.3	203.7
2001-2010	138.1	218.3
non-identified	50.9	30.7
<b>Total</b>	<b>2 258.1</b>	<b>1 795.0</b>

Between the years 1995 and 2007 the number of new dwellings was increasing. However, in last few years a gradual reduction is noticeable.

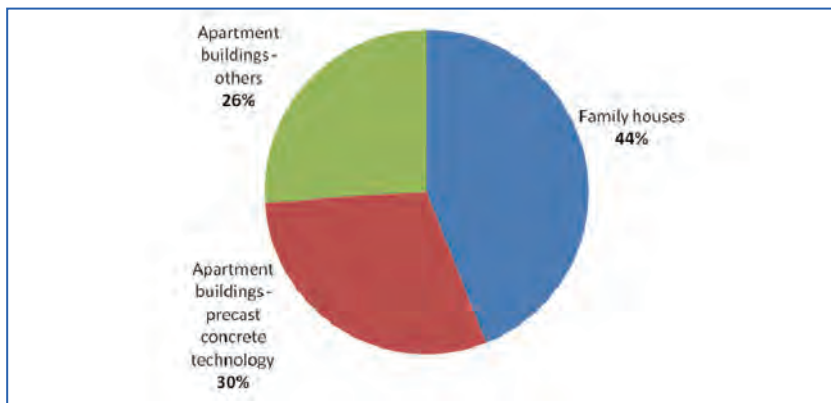


Figure 4.1. Number of dwellings according to building type and technology.

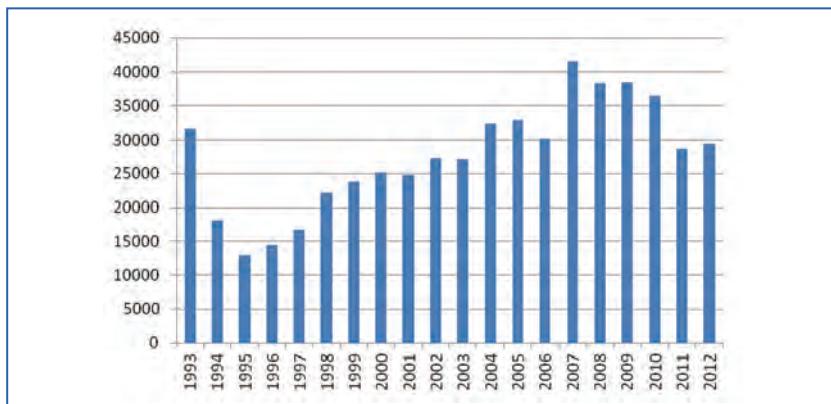


Figure 4.2. Number of new dwellings in last 20 years (1993-2012) [7].

#### 4.1.2. New build housing constructions

The typical new buildings (representing period from 1990-present) are shown in Figure 4.3. Various building technologies are being used nowadays, after the years of modular constructions. Due to the individual architectural character of buildings, smaller structural elements and monolithic concrete structures are popular.



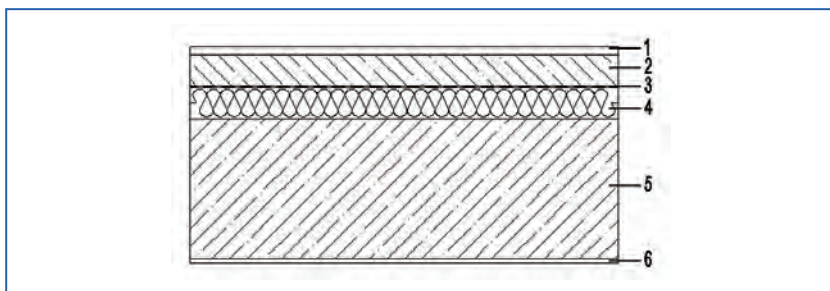
**Figure 4.3.** Typical new residential buildings.

The typical wall constructions are ceramic, silicate or lightweight aggregate concrete hollow blocks and in-situ made concrete walls. The thickness of walls from blocks varies usually between 250 mm and 300 mm, for concrete walls between 180 mm and 250 mm.

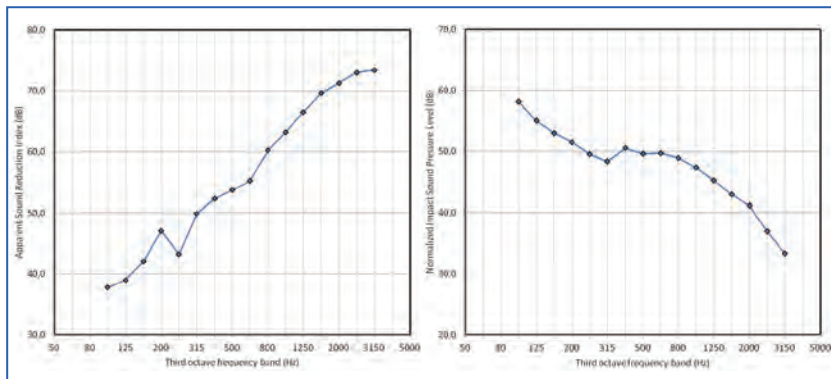
Floors in low rise buildings are usually made from hollow ceramic formers filled with concrete or from precast prestressed concrete panels (especially for wide spans between bearing walls). In high rise buildings monolithic concrete slabs are used.

The values of airborne and impact sound insulation meet requirements given in ČSN 73 0532 [4, 5] (mentioned in 4.1.4).

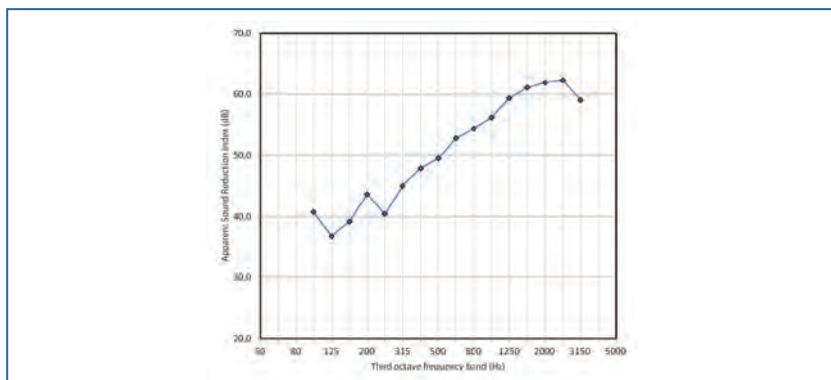
Protection against impact sound is usually ensured by heavy floating floors (see Figure below). Nowadays, the favourite floor covering in habitable rooms is laminate. The soft layer below cement/anhydrite screed is sometimes also used for heating pipes.



**Figure 4.4.** Typical floor structure, 1 – floor covering, 2 – cement/anhydrite screed 40-60 mm, 3 – PE foil, 4 – soft mineral wool board or elastified polystyrene 30-60 mm, 5 – monolithic concrete slab 180-250 mm, 6 – plaster.



**Figure 4.5.** Apparent Sound Reduction Index and Normalized Impact Sound Pressure Level of typical floor construction with 180 mm thick concrete slab (for details see Figure 4.4) measured in a new residential building,  $R'_w=57$  dB,  $L'_{n,w}=50$  dB.



**Figure 4.6.** Apparent Sound Reduction Index of typical wall construction from lightweight aggregate concrete blocks 240 mm plastered both sides measured in a new residential building,  $R'_w=54$  dB.

### 4.1.3. Existing housing

The residential buildings built during the last 100 years were sorted into the following periods:

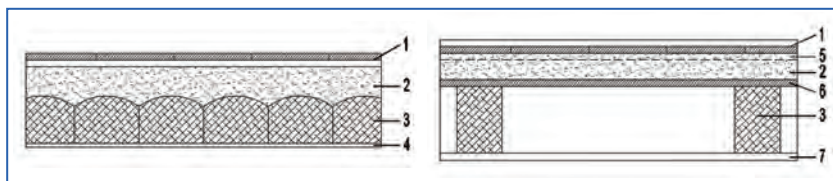
- before 1920;
- 1921-1960;
- 1961-1990;
- from 1991-present (described in 4.1.2).





### Period: before 1920

The elder residential buildings have mixed masonry or stone walls. Family houses had sometimes walls from unfired clay bricks. In later years, the use of solid bricks became more popular. The thickness of facade walls of multistorey buildings varied from 750 mm to 450 mm in the highest floor. The inner bearing walls were 600 mm thick and were usually oriented parallelly to facade. The minimum thickness of partition walls was 150 mm.



**Figure 4.7.** Typical floor constructions from period before 1920,

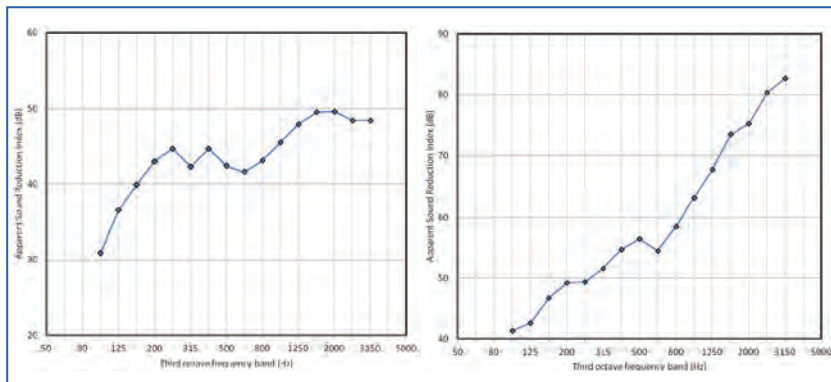
1 – floor covering, 2 – dry infill, 3 – wooden beams, 4 – plaster on reed mat, 5 – wooden laths, 6 – batten cover, 7 - plaster on reed mat and wooden battens.

Floors were built from wooden beams with a plaster on a reed mat at the bottom surface. From upper side the beams were closed with wooden battens, backfilling and wooden top floor (see Figure 4.7).



**Figure 4.8.** Typical buildings from period before 1920.

Sound insulation properties of an old residential building are shown in Figure 4.9. Apparent sound reduction index of floor can vary between approximately 45 dB and 60 dB, depending on the type of structure, material being used, workmanship and flanking constructions.



**Figure 4.9.** Apparent Sound Reduction Index measured in residential building from 1873, 150 mm solid bricks wall with  $R'_w = 46$  dB (left), traditional wooden beam floor with  $R'_w = 60$  dB (right)

### Period: 1921-1960

Buildings were built from solid bricks as in previous period. Some buildings were also with concrete frame and brickwork. As time went on, small bricks were supplied with larger masonry blocks with hollows. The thickness of walls was reduced to approximately 250-300 mm. At the end of this period the use of wall panels started.



**Figure 4.10.** Typical buildings from period 1921-1960.

Initially, floors were with wooden beams as in the past. Later on they were replaced with floors from cinder concrete or hollow clay blocks. Precast concrete floor panels with hollows were also used, usually up to 3 m of clear span. Floor coverings in living rooms were usually made of wood



(parquets, strips, etc.), in other rooms of tiles (stoneware, ceramics, xylolite etc.). Acoustic performance of buildings from this period can't be generalized because a large number of different structures was used.

### *Period: 1961-1990*

Typical buildings from this period, shown in Figure 4.11, were built using precast concrete technology. There were many structural systems with different building elements. The thickness of solid concrete wall panels varied from about 140 mm to 190 mm, the thickness of hollow concrete floor panels from 140 mm to 300 mm.



**Figure 4.11.** Typical buildings from period 1961-1990.

**Table 4.3.** Typical top floors used in buildings from period 1961-1990.

Floor structure No. 1	mm	Floor structure No. 2	mm
Wooden parquets	19	PVC floor covering	2
Adhesive layer	3	Adhesive layer	1
Cement screed	60	Cement screed	20
Bitumen sheet	3		
Mineral wool board	15		
Concrete floor panel			

Acoustic performance of residential buildings from this period is predetermined by Czech Technical Standard CSN 73 0531 [1,2] with requirements for both airborne and impact sound insulation valid at that time (for details see 4.1.4).

#### 4.1.4. Development of requirements on sound insulation

##### 1955

The first Czech Technical Standard with sound insulation requirements was adopted. This document described basic recommendations for the layout of buildings and for sound insulating structures.

Regarding the layout it was stated that: bedrooms should be protected from street noise, frequently used rooms with water discharges (kitchens, bathrooms, toilets) should not be next to the bedroom, pipe installations should not be put into the bedroom walls, pipe installations in walls between apartments can only be if both of these walls belong to the accessory of apartments.

Regarding sound insulation it was stated that:

- a) airborne sounds are attenuated by both walls and floors, impact sounds are attenuated by floors,
- b) average sound attenuation of partitions between flats in the frequency range from 100 Hz to 3150 Hz is at least 48 dB (single walls are appropriate if their surface mass equals to a 25 cm thick wall of solid bricks),
- c) for floors the same airborne sound requirements apply, floors should not transmit the impact sound more than 85 Phons (it can be ensured using floating floors consisting of screed on a soft insulating layer such as a fibrous mat, pulled along the perimeter of the floor).

##### 1961

Updated version of the Technical Standard ČSN 73 0531 [1] introduced new concept of relative sound insulation in buildings. The terms sound reduction index and impact sound pressure level were adopted. Requirements were expressed as single-number relative values determined from the use of the reference curves.

##### 1972

In this new version of Technical Standard ČSN 73 0531 [2], absolute single number quantities were introduced in the form in which we know them until today. Besides the minimum requirements, the recommended values were also stated (for airborne sound insulation between flats it was 51 dB (minimum) and 54 dB (recommended), for impact sound it was 68 dB (minimum) and 58 dB (recommended)).

1994

During the last 20 years the requirements were gradually tightened, as shown in following table (according to ČSN 73 0532 [3,4,5]).

**Table 4.4.** Sound insulation requirements in last 20 years.

Period	Multi-storey housing		Row and terraced family housing	
	$R'_w$ [dB]	$L'_{n,w}$ [dB]	$R'_w$ [dB]	$L'_{n,w}$ [dB]
1994-2000	51	63	51	63
2000-2010	52	58	57	53
2010-present	<b>53</b>	<b>55</b>	<b>57</b>	<b>48</b>

## 4.2. References

- [1] ČSN 73 0531 Building insulation, part III., Sound insulation, 1955 (in Czech).
- [2] ČSN 73 0531 Protection against noise transmission in buildings, 1961 and 1972 (in Czech).
- [3] ČSN 73 0532 Acoustics. Rating of sound insulation of building elements and in buildings. Requirements, 1994 (in Czech).
- [4] ČSN 73 0532 Acoustics - Rating of sound insulation of buildings and acoustic properties of building elements - Requirements, 2000 (in Czech).
- [5] ČSN 73 0532 Acoustics - Protection against noise in buildings and evaluation of acoustic properties of building elements - Requirements, 2010 (in Czech).
- [6] P. Hájek, Building structures 10 – bearing structures, CTU in Prague, ISBN 80-01-01396-0, 1995 (in Czech).
- [7] [www.czso.cz](http://www.czso.cz) (statistical data about the Czech Republic).
- [8] [www.building-typology.eu](http://www.building-typology.eu) (in Czech).



# Building acoustics throughout Europe

## Volume 2: Housing and construction types country by country

# 5

## Denmark

Authors:

**Dan Hoffmeyer<sup>1</sup>**

**Birgit Rasmussen<sup>2</sup>**

<sup>1</sup> DELTA Acoustics, Hørsholm, Denmark  
e-mail: [dh@delta.dk](mailto:dh@delta.dk)

<sup>2</sup> SBi, Danish Building Research Institute, Aalborg University (AAU-CPH),  
Copenhagen, Denmark  
e-mail: [bir@sbi.aau.dk](mailto:bir@sbi.aau.dk)



## CHAPTER

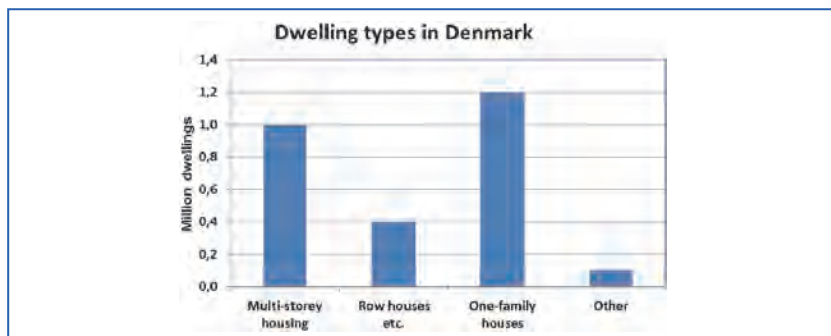
## 5

## Denmark

## 5.1. Overview of housing stock in Denmark

### *The quantities of housing stock and total population*

In Denmark there are approximately 2.7 million dwellings in total. Approximately 1 million of these are in multi-storey housing – having far the highest percentage of people being disturbed by neighbour noise. The number of dwellings in different housing types is shown in Figure 5.1. The total population in Denmark in 2013 is approx. 5.6 mill.



**Figure 5.1.** Number of dwellings in Denmark 2012 according to dwelling type.  
Source: Statistics Denmark [2], rounded numbers.

### *The most populated cities in Denmark*

Table 5.1 shows the population in the four most populated cities in Denmark.

**Table 5.1.** Danish cities with a population of 0.10 million or more.  
Source: Statistics Denmark [2], rounded numbers.

City	Population
Urban Copenhagen/Copenhagen area	1.23 million
Aarhus	0.26 million
Odense	0.17 million
Aalborg	0.11 million



### Proportion of apartments, terraced (row) and detached houses

The proportion of apartments, row houses and detached houses in Denmark are given in Table 5.2.

**Table 5.2.** Existing housing stock in Denmark 2012 [2], rounded numbers.

HOUSING STOCK (dwellings)	Number of dwellings	%
Total Housing	2 700 000	100
Flats / Maisonnettes	1 000 000	38
Attached houses	400 000	14
One-family Houses* (not attached) * Incl. farmhouses	1 200 000	44
Other	100 000	4

Some examples of Danish housing are given in Figure 5.2.



**Figure 5.2.** Examples of different existing housing in Denmark: Apartment houses from four periods, row houses and detached houses.





The average floor area of Danish dwellings depending on building period can be found in Table 5.3.

**Table 5.3.** Number of dwellings and average dwelling size from 1981 to 2012. Table from Denmark in figures 2013 [3].

DWELLINGS						
	Unit	1981	1990	2000	2010	2012
<b>Dwellings, total</b>	1 000	<b>2 180</b>	<b>2 372</b>	<b>2 519</b>	<b>2 749</b>	<b>2 749</b>
Of which:						
One-family houses	-	1 060	1 116	1 152	1 213	1 208
Multi-family buildings	-	902	923	967	1 055	1 062
Terraced houses	-	166	266	314	388	395
Student hostels	-	25	29	34	38	38
<b>Occupied dwellings, total</b>	1 000	<b>2 041</b>	<b>2 246</b>	<b>2 415</b>	<b>2 559</b>	<b>2 583</b>
0-49 m <sup>2</sup>	per cent	7.6	6.8	6.6	5.7	5.8
50-99 m <sup>2</sup>	-	43.8	44.5	44.7	43.4	43.2
100-149 m <sup>2</sup>	-	33.1	32.5	31.2	30.7	30.5
Over 150 m <sup>2</sup>	-	15.4	16.1	17.5	19.9	20.3
Average dwelling size	m <sup>2</sup>	106.0	106.9	107.9	110.9	111.3
Average dwelling size per person	-	42.9	47.1	49.3	51.6	51.8
Persons per dwelling	average	2.5	2.3	2.2	2.1	2.1

≡ www.statbank.dk/bol103 and bol201

### Typical number of new homes built per year

Figure 5.3 shows the number of dwellings according to the year of construction – dwelling types being the same as in Figure 5.1.

As an example of a typical number, in total approx. 21000 new homes were built per year in Denmark in 2004-05.

## 5.2. Building regulations on sound insulation

### Building Regulations

Building acoustic requirements are included in the Danish Building Regulations 2010 [4]. Acoustic requirements for dwellings are not found as figures in the Building Regulations. Instead, it is stated that the requirements are considered to be met, if the acoustic indoor climate in housing complies with sound class C in the Danish classification scheme DS 490:2007 [5], see Figure 5.4.

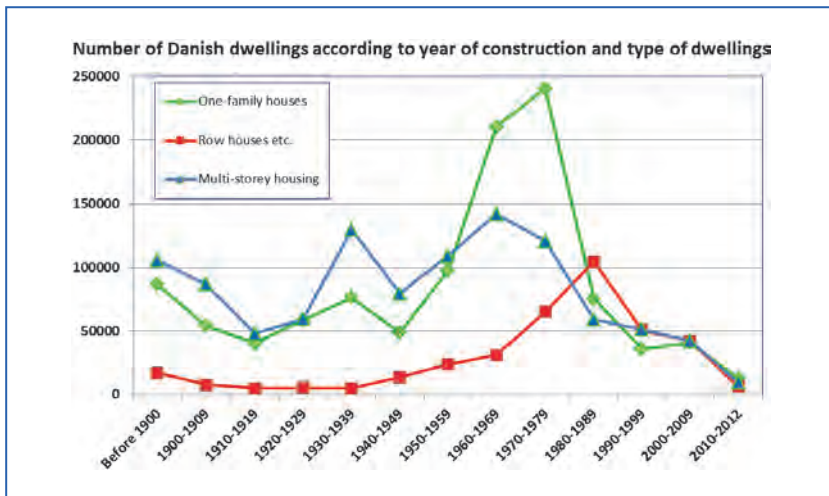


Figure 5.3. Number of Danish dwellings according to year of construction and type of dwellings – 10 year periods from 1900-2009. Source: Statistics Denmark [2].

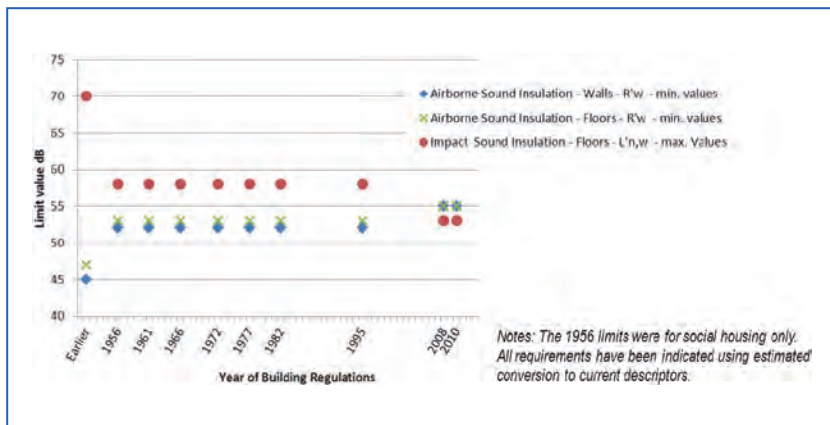
Sound insulation between dwellings Main class criteria in DS 490:2007			Characteristics of DS 490 sound classes for dwellings and occupants' expected evaluation Information compiled based on DS 490		
Class	Airborne	Impact	Sound class descriptions	Good or very good	Poor
A	$R'_{w} + C_{50-3150} \geq 63$ dB	$L'_{n,w} \leq 43$ dB and $L'_{n,w} + C_{1,50-2500} \leq 43$ dB	Excellent acoustic conditions. Occupants will be disturbed only occasionally by sound or noise.	> 90 %	
B	$R'_{w} + C_{50-3150} \geq 58$ dB	$L'_{n,w} \leq 48$ dB and $L'_{n,w} + C_{1,50-2500} \leq 48$ dB	Significant improvement compared to minimum in class C. Occupants may be disturbed sometimes.	70 to 85 %	< 10 %
C	$R'_{w} \geq 55$ dB	$L'_{n,w} \leq 53$ dB	Sound class intended as the minimum for new buildings.	50 to 65 %	< 20 %
D	$R'_{w} \geq 50$ dB	$L'_{n,w} \leq 58$ dB	Sound class intended for older buildings with less satisfactory acoustic conditions, e.g. for renovated dwellings.	30 to 45 %	25 to 40 %
Reference: DS 490:2007, "Lydklassifikation af boliger" (Sound classification of dwellings).			Note: Within each sound class the percentage of satisfied or dissatisfied occupants may depend on the type of criterion. The grouping is mainly based on the subjective assessments of airborne and impact sound from adjacent dwellings.		

Figure 5.4. Requirements according to the Danish Building Regulations 2010 are given as class C in the Danish classification scheme DS 490:2007 [5].

Building acoustic requirements have been included in the Danish Building Regulations since 1956 [4],[6]. A summary of the main requirements for sound insulation between dwellings as found in the successive Danish Building Regulations since 1956 is shown in Figure 5.5 [8]. Since 1982,  $R'_{w}$  and  $L'_{n,w}$  have been used as descriptors for sound insulation in the Danish



Building Regulations. Before 1982, various descriptors have been used in building regulations, but in Figure 5.5, the limit values have been converted to estimated values using the descriptors applied in the current regulations in Denmark.



**Figure 5.5.** Development in building acoustic requirements in the Danish Building Regulations. Refs: [4],[6].

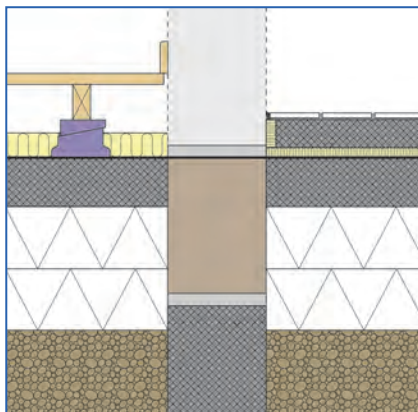
As seen in Figure 5.5, the limit values for airborne and impact sound insulation in Denmark had been constant for more than 50 years, until an adjustment was made in the Building Regulations 2008. Before building acoustic requirements were introduced in Building Regulations, the quality of the Danish dwellings regarding sound insulation in general was lower. Figure 5.5 shows estimated values representing typical housing constructions from that period, i.e. thin brick walls and timber floor constructions [13],[14].

## 5.3. New build housing constructions

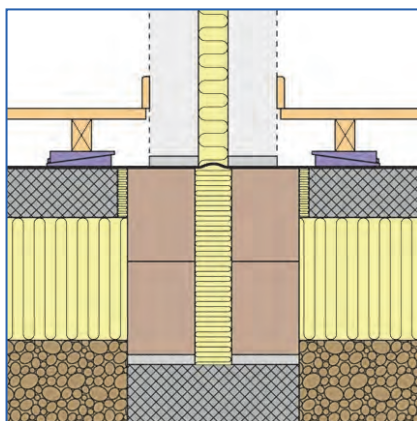
### 5.3.1. Terraced housing

#### *Typical heavy constructions*

Most new terraced houses have party walls made from concrete or light-weight concrete elements. Both solid walls and cavity walls are used as party walls in terraced housing. An example of a solid wall construction fulfilling the newest building requirements is shown in Figure 5.6 and an example of a heavy cavity wall in Figure 5.7 [7].



**Figure 5.6.** Example of Danish heavy solid wall construction for new terraced housing fulfilling the Danish Building Regulations 2010. From [7], where more information about materials and dimensions can be found.  
The cross section shows party wall and foundations.



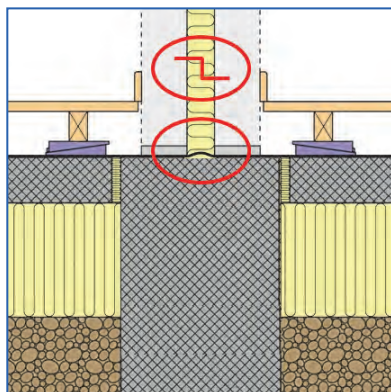
**Figure 5.7.** Example of Danish heavy cavity wall construction for new terraced housing fulfilling the Danish Building Regulations 2010. From [7], where more information about materials and dimensions can be found.  
The cross section shows party wall and foundations.

### Typical errors in design and workmanship

Some examples of errors experienced with heavy cavity walls are illustrated in Figure 5.8.



For solid walls information about typical errors is found in Figure 5.10 and Figure 5.12.

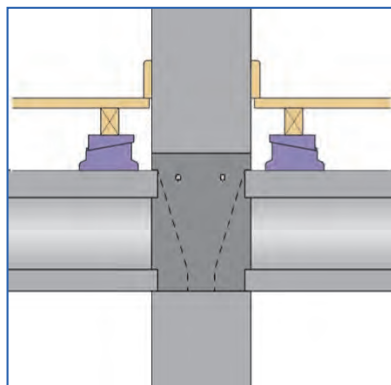


**Figure 5.8.** Typical errors such as insufficiently separated double walls with wall ties bridging the cavity wall or both leaves of the cavity wall located on the same foundation, compare with Figure 5.7.

### 5.3.2. Apartments/flats

#### *Typical heavy constructions*

Most new apartment houses are made from precast concrete elements. A recommended construction fulfilling the newest building requirements is shown in Figure 5.9.



**Figure 5.9.** Example of Danish heavy wall / heavy floor construction for new apartment houses fulfilling the Danish Building Regulations 2010 [4].

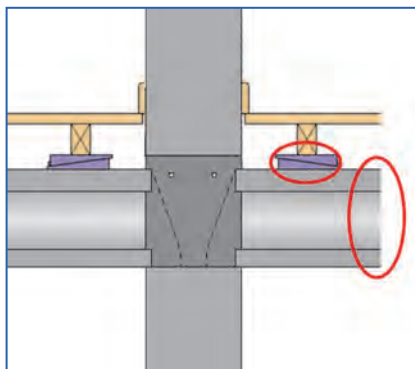


It is recommended that the hollow core slabs have a surface mass of  $440 \text{ kg/m}^2$  [7]. The joist floor consisting of a wooden floor finish on timber joist on polyethylene (PE) floor wedges has a total height of 170 mm. The wall is made from 200 mm full size wall concrete elements.

A typical heavy facade construction consists of full size wall concrete elements with e.g. 150 mm inner wall, mineral wool in the cavity and 70 mm outer wall.

### *Typical errors in design and workmanship*

A typical design error may be to design the floors according to the former less strict requirements valid before 2008, see Figure 5.10. Although the requirements have been strengthened in 2008, the old way of building with 180-220 mm hollow core elements with surface mass  $310\text{-}330 \text{ kg/m}^2$  is sometimes used. Depending on the flanking walls etc., this construction fails to meet the impact sound requirement,  $L'_{n,w} \leq 53 \text{ dB}$ .

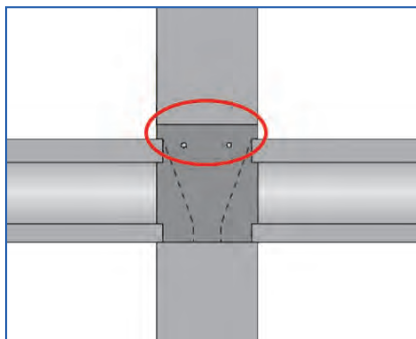


**Figure 5.10.** An example of a typical design error in heavy built apartment houses (insufficient impact noise reduction in joist floor construction and insufficient surface mass of the hollow core elements).

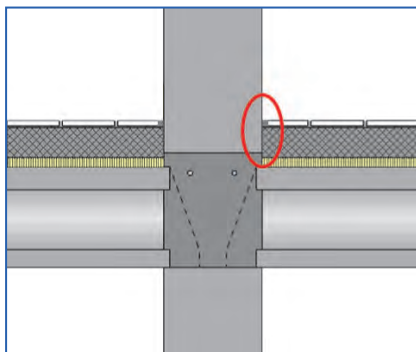
Workmanship errors related to heavy built apartment houses could be either leaks or unintended connections. These errors are illustrated in Figure 5.11 and Figure 5.12.

### *Typical light-weight constructions*

Till now light-weight constructions in multi-storey houses have only been used on a limited scale. More often heavy floors are combined with light-



**Figure 5.11.** Leaks at element joints (insufficient grouting) as an example of a typical error when using concrete elements.

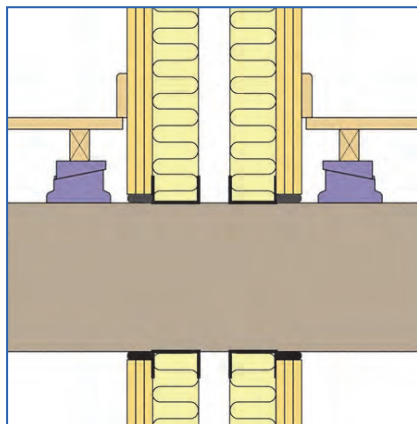


**Figure 5.12.** Heavy floating floors with unintended connection to the wall is a typical workmanship error.

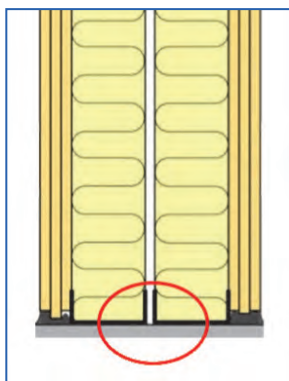
weight party walls as described in Figure 5.13. Light-weight walls commonly consist of a double metal framework with plasterboard linings. The surface mass of the plasterboards on each side should be approx.  $20 \text{ kg/m}^2$ . The heavy floor shown is composed of  $180 \text{ mm}$  light-weight concrete slab ( $2000 \text{ kg/m}^3$ ). The wooden floor finish on joists on PE floor wedges must have an impact sound pressure level reduction of  $\Delta L_w \geq 20 \text{ dB}$  [7].

### *Typical errors in design and workmanship*

Insufficiently separated wall frames – either due to rigid connections limiting the sound insulation performance or due to a reduced wall cavity depth, which does not meet Danish low frequency requirements – can occur as a common design error in light-weight walls, see Figure 5.14.



**Figure 5.13.** Example with a heavy floor combined with a light-weight party wall, see detailed description in text. From [10].



**Figure 5.14.** Insufficiently separated wall frames (insufficient distance between linings or rigid connection through e.g. thin slabs) as an example of a typical design error.

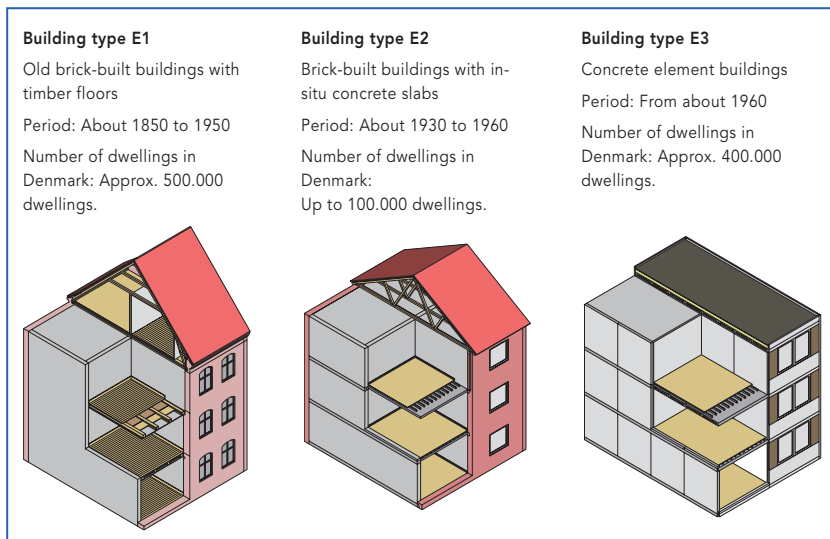
## 5.4. Existing housing

### *Typical constructions found in existing stock*

Main building types in different time periods are shown in Figure 5.15 [8], [11], [12].

Below are presented an example of a building type built before 1950 (building type E1) and a building type built after 1960 (building type E3),





**Figure 5.15.** Overview of the main building types and construction characteristics for multi-storey housing in Denmark. The building types are denoted E1-E3 as in a new Danish guideline [12].

with the description of their most common separating walls and floors and their average sound insulation.

### *Buildings built before 1950 (type E1): Brick-built with timber floors*

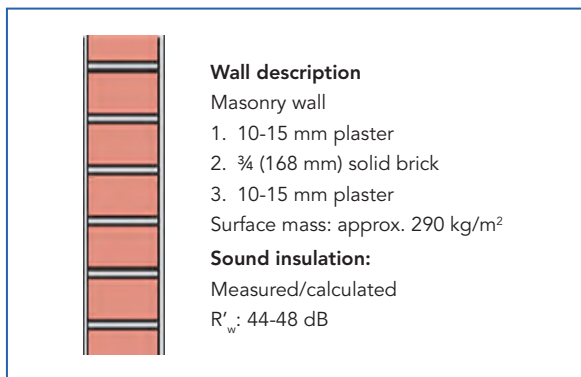
An example of a typical Danish apartment building built before 1950 is shown in Figure 5.16.



**Figure 5.16.** Brief description of building type commonly used up to 1950. The photo shows a typical type of building from this period.



Figure 5.17 and Figure 5.18 show the typical sound insulation performance between common Danish apartments built before 1950.



**Figure 5.17.** Wall performance in building type commonly used up to 1950.

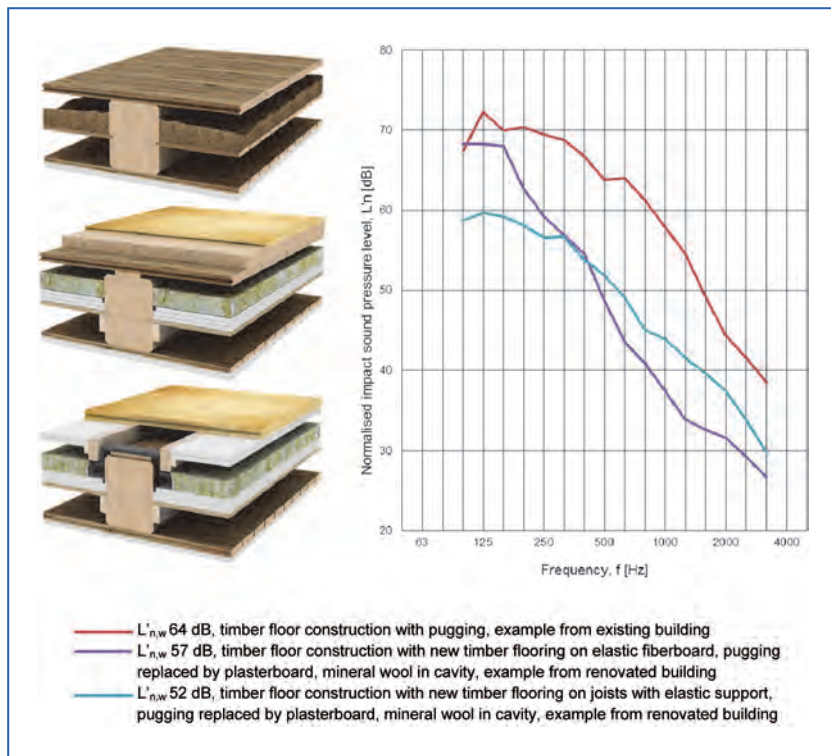


**Figure 5.18.** Floor performance in building type commonly used up to 1950. Drawing from [9], [15].

### Methods of improving sound insulation

Two major projects [13] and [14] concerning improvements of the sound insulation between dwellings in the existing housing stock have been carried out in Denmark during the last years, and some examples and test results from field measurements of improved floor constructions in old housing with timber floors are shown in Figure 5.19.

The examples focus on impact sound insulation.



**Figure 5.19.** Impact sound insulation, examples from measurements 2004-2005, [15], in old housing with timber floors. Two different solutions for improvements are shown. Drawings are from [9], [15].


### Buildings built after 1960 (type E3): Concrete element buildings with floor on timber joists

An example of a typical Danish apartment building built after 1960 is shown in Figure 5.20.

Figure 5.21 and Figure 5.22 show the typical sound insulation in a typical Danish apartment building built after 1960.


### Methods of improving sound insulation

Examples and test results from field measurements [14] of improved heavy floor constructions are shown in Figure 5.23. The examples focus on impact sound insulation.

<p><b>Period: 1970-2008</b>                  Brief description:                  Floor: 180-220 mm hollow core concrete slabs with wooden floor on joists on PE wedges                  Party wall: 150 mm precast concrete walls                  Inner wall: Aerated concrete / Light weight plasterboard walls                  Regulations: e.g. BR1982 and BR1995</p>							
Regulations	Airborne Horizontal	Airborne Vertical	Impact				
Sound insulation	↔	↕	↕				
Descriptor	$R'_w$	$R'_w$	$L'_{n,w}$				
Frequency range	100-3150	100-3150	100-3150				
Value	52 dB	53 dB	58 dB				

**Figure 5.20.** Brief description of building type commonly used from about 1960. The photo shows a typical type of building from that period.

150 mm

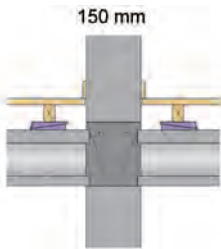


**Wall description**  
 150 mm precast concrete units  
 Surface mass: 350 kg/m<sup>2</sup>

**Sound insulation**  
 Measured/calculated  
 $R'_w$ : 52-54 dB

**Figure 5.21.** Wall performance in building type commonly used after 1960.

150 mm

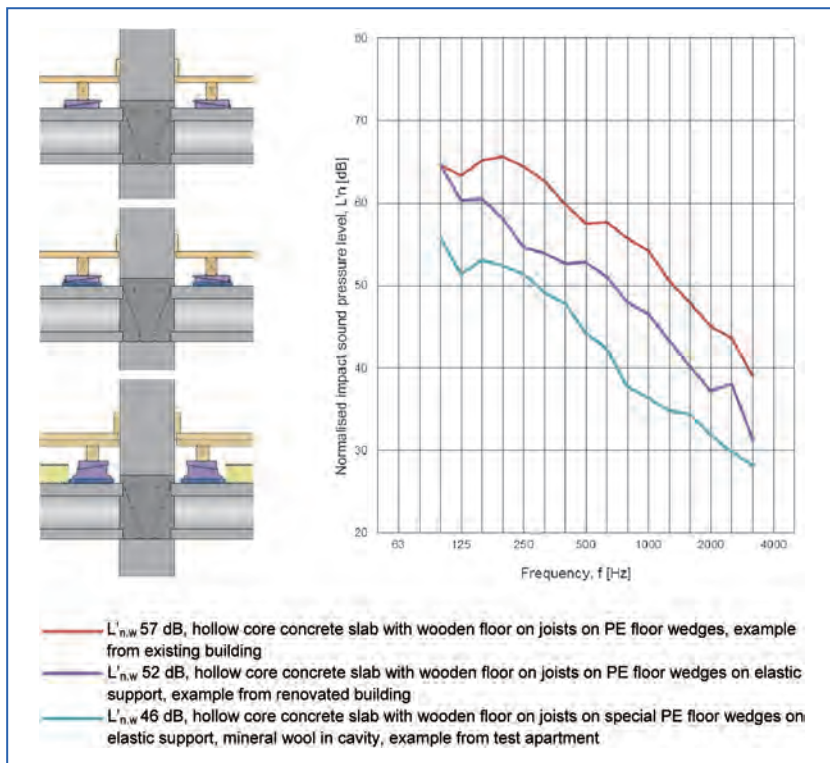


180-220 mm

**Floor description:**  
 180-220 mm hollow core concrete slabs with wooden floor on joists on PE wedges  
 Surface mass: 310-330 kg/m<sup>2</sup>

**Sound insulation:**  
 Measured/calculated  
 $R'_w$ : approx. 53 dB  
 $L'_{n,w}$ : approx. 58 dB

**Figure 5.22.** Floor performance in building type commonly used after 1960.



**Figure 5.23.** Impact sound insulation, examples from in situ measurements performed in 2012 in existing housing with hollow core concrete slabs. Two different solutions are shown of improvements of wooden floor finishes, leading to the compliance with the new Danish requirements (max 53 dB), [14].

## 5.5. References

- [1] COST Action TU0901 «Integrating and Harmonizing Sound Insulation Aspects in Sustainable Urban Housing Constructions». [www.cost.eu/domains\\_actions/tud/Actions/TU0901](http://www.cost.eu/domains_actions/tud/Actions/TU0901), [www.costtu0901.eu](http://www.costtu0901.eu) WG3: Design and acoustic performance of building constructions for multi-storey housing. TU0901 runs 2009-2013 and has 32 member countries and in total about 100 WG members.
- [2] Statistics Denmark. Statbank, [www.dst.dk/en/Statistik.aspx](http://www.dst.dk/en/Statistik.aspx), and yearbooks, [www.dst.dk/en/Statistik/Publikationer.aspx](http://www.dst.dk/en/Statistik/Publikationer.aspx)
- [3] DENMARK IN FIGURES 2013. Statistics Denmark, 2013. [www.dst.dk/pukora/epub/upload/17953/dkinfigures.pdf](http://www.dst.dk/pukora/epub/upload/17953/dkinfigures.pdf)

- [4] [www.byningsreglementet.dk/tidligerebygreg/0/40](http://www.byningsreglementet.dk/tidligerebygreg/0/40). [www.w2l.dk/file/155699/BR10\\_ENGLISH.pdf](http://www.w2l.dk/file/155699/BR10_ENGLISH.pdf)
- [5] DS 490:2007 "*Lydklassifikation af boliger*" (Sound classification of dwellings). Danish Standards, 2007.
- [6] Birgit Rasmussen & Jens Holger Rindel, "*Lydforhold i boliger - State-of-the-art*" (Acoustic Conditions in Dwellings - State-of-the-Art) by. Bygge- og Boligstyrelsen, Boligministeriet (National Housing and Building Agency, Danish Ministry of Housing and Building), 1994. [http://vbn.aau.dk/en/publications/lydforhold-i-boliger--stateoftheart\(ae71be40-1d07-11de-bddb-000ea68e967b\).html](http://vbn.aau.dk/en/publications/lydforhold-i-boliger--stateoftheart(ae71be40-1d07-11de-bddb-000ea68e967b).html).
- [7] Rasmussen, B. & Petersen, C.M. & Hoffmeyer, D.(2011). "*Lydisolering mellem boliger – nybyggeri*" (Sound insulation between dwellings – new housing). SBI guideline 237. Danish Building Research Institute, Aalborg University Denmark.
- [8] Birgit Rasmussen & Dan Hoffmeyer, "Sound insulation performance in Danish multi-storey housing 1850-2009 and upgrade possibilities to meet current regulations", InterNoise2013, Innsbruck, Proceedings, I-INCE, 2013.
- [9] Solutions for improved sound insulation in old housing. Hoffmeyer, Dan; Rasmussen, Birgit. 2010. Poster session presented at European symposium of EAA TC-RBA and Cost Action TU0901, Florence, Italy.
- [10] Constructions complying with tightened Danish sound insulation requirements for new housing. Rasmussen, Birgit; Hoffmeyer, Dan. 2010. Poster session presented at European symposium of EAA TC-RBA and Cost Action TU0901, Florence, Italy.
- [11] [www.danskyggeskik.dk/pdf/get.action?pdf.id=188](http://www.danskyggeskik.dk/pdf/get.action?pdf.id=188)
- [12] Rasmussen, B. & Petersen, C.M. (2014). "*Lydisolering mellem boliger-eksisterende byggeri*" (Sound insulation between dwellings-existing housing). SBI guideline 243. Danish Building Research Institute, Aalborg University, Denmark.
- [13] Project "*Bedre lydisolering i nyrenoverede boliger*" (Better sound insulation in newly renovated homes), 1999-2006. Funded by the Danish Ministry of Housing and Building & GI (The Danish Landowners Investment Fund). Several publications published, incl. a brochure/flyer and website, see <http://www.ejendomsviden.dk/indeklima/nabost%C3%B8j/Sider/default.aspx>.
- [14] Project "*Lydisolation mellem boliger i etagebyggeri – Kortlægning og forbedringsmuligheder*" (Sound insulation between dwellings in multi-storey housing - Mapping and possibilities for improvements), 2009-2014, Danish Building Research Institute. Project funded by Aase and Ejnar Danielsen's Foundation, Kgs. Lyngby, DK, and The National Building Fund, Copenhagen, Denmark.
- [15] DOMINIA A/S. Unpublished results.



# Building acoustics throughout Europe

## Volume 2: Housing and construction types country by country

# 6

## Estonia

Authors:

Marko Ründva<sup>1</sup>  
Linda Madalik<sup>2</sup>

<sup>1</sup> Akukon Oy Estonian branch, Tallinn, Estonia  
e-mail: marko.ryndva@akukon.ee

<sup>2</sup> FIE Linda Madalik, Tallinn, Estonia  
e-mail: madalikl@smail.ee



## CHAPTER

## 6

## Estonia

## 6.1. Design and acoustical performance: Estonia

### 6.1.1. Overview of housing stock

In this paragraph information on the population, building typology and quantity of housing stock is reported about Estonia. Most of the data were taken from Statistics Estonia [1] and Estonian Registry of Buildings [2]; useful information was found in different studies of Estonian residential building stock by Faculty of Civil Engineering Tallinn University of Technology (financed by the Estonian State Fund KredEx) [3].

The population of the Estonian Republic is about 1,3 million according to Statistics Estonia [4]. There are four cities with population over 40 000.

**Table 6.1.** Biggest cities in Estonia (data 2013).

City	Population
Tallinn	~419 000
Tartu	~98 000
Narva	~63 000
Pärnu	~42 000

The housing stock of residential buildings in Estonia is given in Table 6.2. Around 93 000 dwellings are not permanently inhabited.

**Table 6.2.** Housing stock in Estonia (data 2013).

Housing Stock	Number of dwellings	%
<b>Total Housing</b>	650 000	100
Flats/Maisonnettes	447 000	69
Attached houses and others	25 000	4
Private houses (detached)	178 000	27

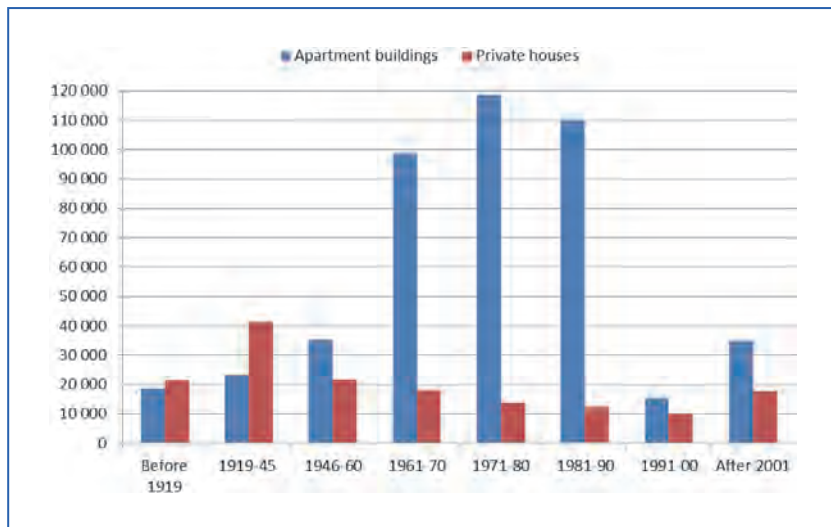
There are altogether ~216 000 buildings with living premises: apartment buildings ~23 600, private houses ~178 100, attached houses ~13 200 and ~800 non-residential buildings with apartments.



The housing stock of residential buildings in Estonia is given in Table 6.3.

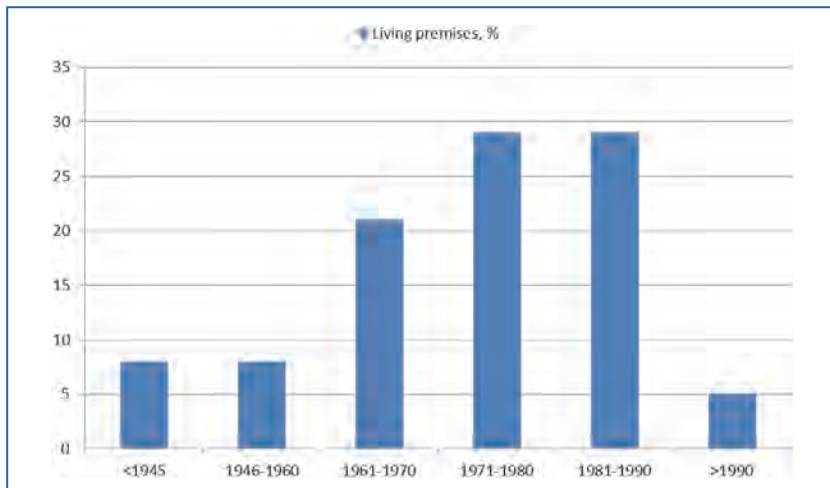
**Table 6.3.** Housing stock in according to the period of construction.

Period of construction	Number of dwellings	
	Apartment buildings	Family houses
Before 1919	18 500	21 400
1919-1945	23 300	41 200
1946-1960	35 300	21 800
1961-1970	98 800	17 900
1971-1980	118 700	13 900
1981-1990	110 300	12 300
1991-2000	15 600	10 200
After 2001	34 800	17 700



**Figure 6.1.** Housing stock according to period of construction.

During the last 2 decades the building of new dwellings has dramatically decreased, meaning that most of the inhabitants live in dwellings older than 20 years. Typical annual new housing outputs:



**Figure 6.2.** Percentage of living premises built during different periods.

The number of dwellings built per year in Estonia during period of 2003-2012 is given in Figure 6.3.

**Table 6.4.** New housing outputs.

Year	Number of new dwellings
2003	~2400
2004	~3100
2005	~3900
2006	~5100
2007	~7100
2008	~5300
2009	~3000
2010	~2300
2011	~1900
2012	~2000

Of newly built houses ~56% consists of block of flats. In apartment buildings there are mainly 40-49 m<sup>2</sup> size 2-rooms and 60-79 m<sup>2</sup> size 3-rooms apartments.

The average floor area of a dwelling per person in Estonia is 30,5 m<sup>2</sup> (situation 2011).

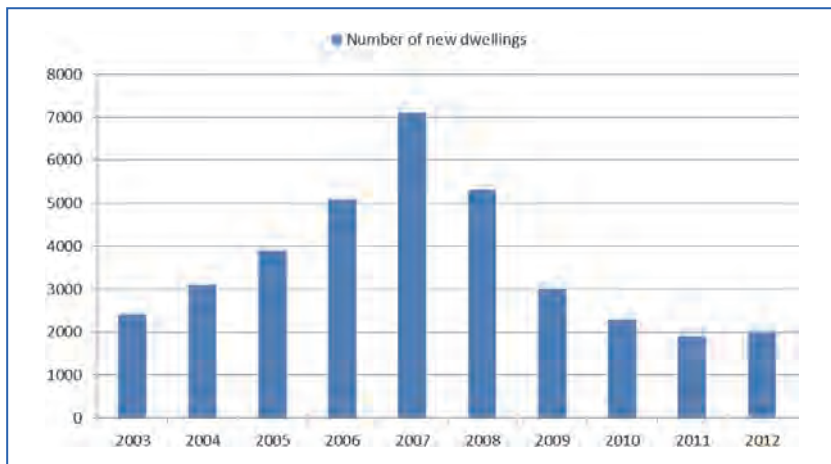


Figure 6.3. Number of built dwellings per year.

In Estonian society there is a strong sense of necessity of owning one’s own dwelling, which is supported by statistical data, showing that over 96 percent of the dwellings are privately owned.

### 6.1.2. New build housing constructions

#### Typical constructions

Massive constructions are widely used in construction of residential buildings in Estonia. Lightweight constructions are found mostly within dwellings, as separating walls between rooms inside a dwelling, but in some case lightweight wall structures are used between the dwellings.



Figure 6.4. Photos: a) Massive structures a; b) Detached row-house.

Lightweight timber and steel floors are used in lightweight module buildings, but such building type is still seldom used. Lightweight floors can be found more often in family houses or weekend houses (converted from old family houses).

Various wall structures are used in new dwellings:

- Lightweight wall on wooden or steel studs (typically 2+2 gypsum boards on both side of double studs), total thickness 200-300 mm;
- Monolithic concrete walls (in-situ) or monolithic concrete panels, wall thickness 180-200 mm;
- Concrete hollow blocks (filled with concrete), wall thickness 190 and 240 mm;
- Double wall from autoclaved aerated concrete blocks (100 mm block/100 mm void filled with mineral wool/ 150 mm block);
- Single or double wall from light expanded clay aggregate blocks (single layer 250-300 mm, double wall 100 mm block/ 100 mm void filled with mineral wool/ 150 mm block or other similar);
- Combined wall structures (blocks and lightweight cladding).

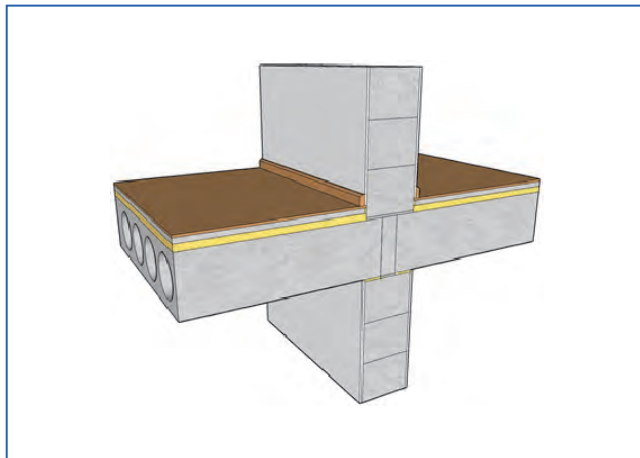
Total thicknesses of walls vary between 180-400 mm. Lightweight block walls are usually double walls or with one side or two side gypsum board cladding. Normally mineral wool (15-40 kg/m<sup>3</sup>) is used as sound absorbing material in the cavity. All described wall structures fulfil single number requirement  $R'_w \geq 55$  dB.

Various floor structures are used in new dwellings:

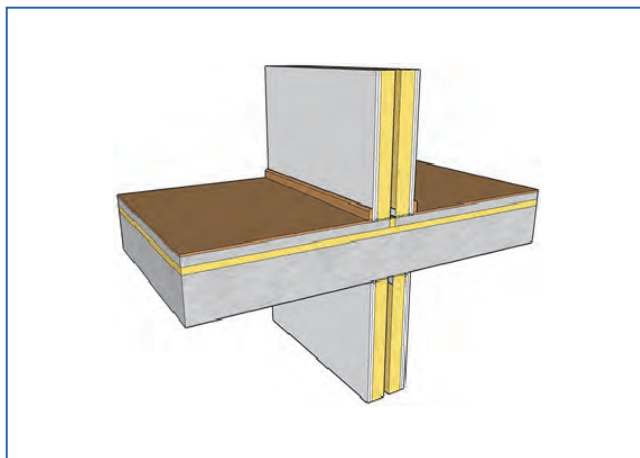
- Concrete hollow-core panels (220, 265, 320 mm) with concrete floating floors (60-80 mm) on load bearing mineral wool or EPS boards (30-50 mm);
- Monolithic concrete slabs (180-250 mm) with concrete floating floors (60-80 mm) on load bearing mineral wool or EPS boards (30-50 mm);
- Seldom are used lightweight floating floors on hollow-core panels or on massive concrete slabs (lightweight floating floor means building boards of load bearing mineral wool);
- Lightweight floor structures on wooden beams, glulam beams, trusses, steel beams with lightweight floating floor or flooring material on elastic underlay.



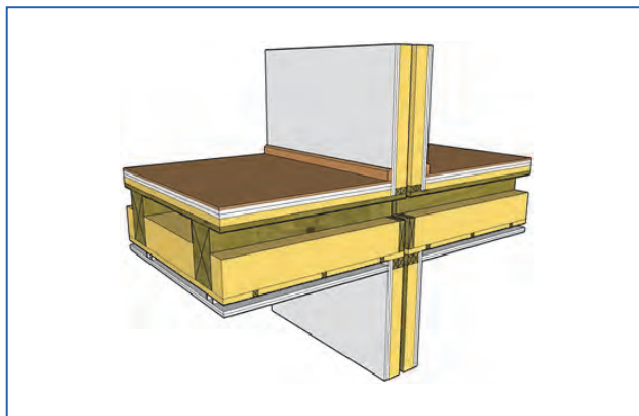
Impact sound insulation requirement  $L'_{n,w} \leq 53$  dB assumes that in most cases a floating floor structure shall be used or special underlay is used under the flooring material (very seldom used). Protection against impact sound is usually ensured by heavy floating floors (see Figures below).



**Figure 6.5.** Massive wall structure and concrete floating floor on hollow-core panels.



**Figure 6.6.** Lightweight wall structure and concrete floating floor on monolithic concrete slab.



**Figure 6.7.** Lightweight wall structure and lightweight floating floor on wooden beams.

There are no major airborne sound insulation problems in vertical direction due to widely used massive intermediate floor slabs. The results  $R'_w \geq 53$  dB should be considered as providing sufficient sound insulation (as a rule no complains); if design phase or construction works do not follow principles set in EVS 842:2003, then results usually 48-52 dB.

Due to the widely used concrete floating floors on massive panels/slab there are no major impact sound insulation problems in vertical directions. The weighted normalized impact sound pressure level  $L'_{n,w}$  is typically  $\leq 48-50$  dB (also exceptionally good results occurred  $L'_{n,w} \leq 45$  dB).

### *Typical errors in design and workmanship*

The main reasons for non-fulfilling sound insulation requirements in dwellings in horizontal directions are:

- Wrong structural solution/structural type (partly due to the fact that data from suppliers is not on the same level);
- Insufficient mass of structures;
- Substitution of designed wall structures (mainly block walls) to lighter structures;
- Mainly problems with lightweight block structures – no valid measurement data for structures, insufficient information from producers;



- Construction mistake (for example nonsufficient plastering, filling joints, etc);
- Incorrect solution for connection detail between wall and intermediate slab (for example concrete floating floor continues under the wall from one apartment to another);
- A flanking wall reduces airborne and impact sound insulation between two rooms;
- Incorrect solution for connection detail between wall and lightweight façade (internal layers for façade continue from one apartment to another);
- Influence of power sockets in lightweight walls.

The main reasons for non-fulfilling results in vertical directions are:

- Nonsufficient elastic layer in floating floor structure (wrong properties, too thin layer);
- Mass of floor structure is not sufficient;
- Poor sound insulation of lightweight floor structures on low frequencies.

### 6.1.3 Existing housing

The existing residential buildings can be divided into following types:

- Wooden buildings <1940;
- Brick buildings 1950-1960;
- Concrete element buildings 1970-1990;
- Brick buildings with massive intermediate slabs (1980-1990)



**Figure 6.8.** Photos: a) Wooden building; b) Concrete element building.



**Figure 6.9.** Photos: a) Brick building (1980's); b) Brick element building (1950's).

The oldest residential buildings have mixed masonry, brick or stone walls. In later years, the use of solid bricks expanded.

In old wooden and brick buildings the intermediate slab were wooden structures (wooden beams) or thin concrete slab supported by steel beams. From top side the beams were closed with wooden battens, backfilling and wooden top floor.

Sound insulation properties of an old residential building are vary depending on structure. Apparent sound reduction index  $R'_w$  in vertical direction can vary between 40-60 dB, depending on the type of structure, material being used, workmanship and flanking constructions. In the horizontal direction apparent weighted sound reduction index  $R'_w$  is typically between 45-58 dB.

The weighted normalized impact sound pressure levels  $L'_{n,w}$  vary between 55-70 dB.

### *Methods of improving sound insulation*

The most common solution for improving airborne sound insulation of a wall structure is adding to one or both sides gypsum board cladding on independent studs or using elastic elements for fixing the studs to base wall. With such improvement it is usually possible to gain around 5 dB improvement to airborne sound insulation between the dwellings, in best cases up to 10 dB.

In case lightweight block walls are used, then additional plastering may improve airborne sound insulation few dB.



For improvement of impact sound insulation there are three main solutions:

- making gypsum board suspended ceiling using elastic hanger/profile systems;
- making new lightweight floating floor using loadbearing mineral wool (30 mm) and double layer buildings boards (OSB, floor gypsum boards, etc) on top of it;
- using special elastic underlay under flooring material (typically laminated or natural parquet is used as flooring material in dwellings).

## 6.2. Development of sound insulation requirements in residential buildings

In the first Estonian normative document regarding building acoustics "Temporary Regulations for Building Acoustics and Protection Against Noise" (1992) airborne sound insulation requirement between the apartments was  $R'_{w} \geq 52$  dB (55 dB for row houses) and for impact sound insulation the requirement was  $L'_{n,w} \leq 60$  dB. Before that former Soviet Union design norms SNIP were followed. In 1997 building acoustics regulations EPN 16 was developed, where the requirements had been increased - airborne sound insulation requirement between the apartments  $R'_{w} \geq 55$  dB and for impact sound insulation the requirement was  $L'_{n,w} \leq 53$  dB. In 1999 a modification of EPN 16 was introduced called as EPN 16.1. In this document spectrum adaption terms  $C_{50-3150}$  for airborne sound insulation and  $C_{1,50-2500}$  for impact noise insulation were introduced as a new concept, but their use was not compulsory. In 2003 the new Estonian national standard EVS 842:2003 "Sound insulation requirements in buildings. Protection against noise" was published, there were no significant changes compared to EPN 16.1

The basis for EPN 16, EPN 16.1 and EVS 842:2003 were similar standards, their drafts and general concepts in the Nordic countries and in Germany.

For calculation of single-number quantities, only the values in third octave bands from 100 Hz to 3150 Hz are used. Spectrum adaptation terms are calculated as well, but it is not compulsory to use them.

## 6.3. Conclusions

In Estonia the current regulation for sound insulation is valid from 2003 (same single-number since 1997). The sound insulation measurements are

not mandatory and is typically carried out based on the requests from the real estate developer or construction company. For old buildings built before 1997 requirements valid during the design and construction of a residential building should be followed.

It shall be mentioned that the Estonian housing stock is quite varied and there are variations in housing types and construction systems.

## 6.4. References

- [1] Statistics Estonia <http://www.stat.ee/en>
- [2] Estonian Registry of Buildings <http://www.ehr.ee/>
- [3] Kredex <http://www.kredex.ee/energiatohususest/energiatohusus/uuringud/>
- [4] EVS 842:2003 "Sound insulation requirements in buildings. Protection against noise", Estonian Centre for Standardisation.



# Building acoustics throughout Europe

## Volume 2: Housing and construction types country by country

# 7

## Finland

Authors:  
**Heikki Helimäki**  
**Matias Remes**  
**Pekka Taina**

Helimaki Acoustics  
Tempelikatu 6 B, 00100 Helsinki, Finland  
heikki.helimaki@helimaki.fi



## CHAPTER

## 7

## Finland

## 7.1. Introduction

### 7.1.1. Total population and key figures of housing stock

The total population in Finland at the end of 2013 was 5,435,300 inhabitants. The most populated cities in Finland are: Helsinki (population 610,601), Espoo (259,383), Tampere (219,624), Vantaa (206,960), Oulu (192,680), Turku (181,569), Jyväskylä (133,420) and Lahti (103,344) [11].

The following key figures can be reported regarding Finnish housing stock (data from end of 2012) [8]:

- The total number of dwellings is 2,866,000.
- The number of blocks of flats is 1,269,000 (44 % of total), that of detached houses 1,257,600 (43 %) and terraced houses 390,000 (13 %). Since 1990, the increase in dwelling stock has been 30,000 dwellings / year.
- Average floor area of dwellings is 80 m<sup>2</sup>. The average floor area of the dwelling stock has grown by about 20 m<sup>2</sup> since 1970.
- The number of rented dwellings is about 833,000, which has grown by 287,000 since 1990.

Most dwellings were built in the 1970's and 1980's. Residential building construction has centred in urban municipalities. In all, 76 per cent of the dwellings completed in the 1995-2012 period are located in urban areas [8].

Figure 7.1 presents the number of building permits granted for dwellings [9].

Figure 7.2 presents the proportion of dwellings for different building types in Finland [8].

### 7.1.2. Development of acoustic regulations in dwellings

Table 7.1 presents the development in regulations and guidelines regarding airborne and impact sound insulation between dwellings in Finland from 1955 to the current regulation level (2000). The quantities



Figure 7.1. Number of building permits granted for dwellings in Finland 2000-2013, variable annual sum [9].

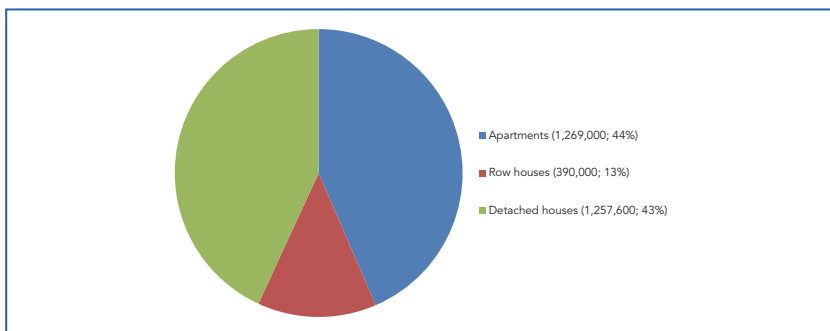


Figure 7.2. Proportion of dwellings for different building types in Finland [8].

are the apparent weighted sound reduction index  $R'_w$  (vertical and horizontal direction) and the normalised weighted impact sound pressure level  $L'_{n,w}$ . The values have been converted to correspond to currently used acoustical descriptors  $R'_w$  and  $L'_{n,w}$  [6].

## 7.2. New build housing constructions

### 7.2.1. Background to currently used constructions

Sound insulation requirements in Finnish housing construction became stricter in 2000 as a result of the new Building Code, Section C1-1998. To meet the new requirements (see Table 7.1), a structural design guide for

concrete-built apartment and terraced houses was published the same year by the Confederation of Finnish Construction Industries [2].

**Table 7.1.** Regulations and guidelines of airborne and impact sound insulation between dwellings in Finland from 1955 to 2000 [6].

Year	$R'_{w}$ horizontal direction	$R'_{wv}$ vertical direction	$L'_{n,w}$
1955	$\geq 51$ dB	$\geq 51$ dB	$\leq 62$ dB
1960	$\geq 52$ dB	$\geq 52$ dB	$\leq 56$ dB
1967	$\geq 52$ dB	$\geq 53$ dB	$\leq 58$ dB
1971	$\geq 52$ dB	$\geq 53$ dB	$\leq 58$ dB
1976	$\geq 52$ dB	$\geq 53$ dB	$\leq 58$ dB
1985	$\geq 52$ dB	$\geq 53$ dB	$\leq 58$ dB
2000	$\geq 55$ dB	$\geq 55$ dB	$\leq 53$ dB

Sound insulation measurements conducted in dwellings from 2007 onwards indicated that there are problems in satisfying the new sound insulation regulations when the volume of the receiving room exceeds 60 m<sup>3</sup>. Measurement results failing to meet the requirements were found especially in vertical impact sound insulation and horizontal airborne sound insulation between dwellings. It was found that large receiving room volume significantly deteriorates the  $R'_{w}$  - or  $L'_{n,w}$  - value calculated from the measurement results. To correct this flaw, a recommendation was made – and later approved by the Finnish Rakennustarkastusyhdistys RTY – to limit the receiving room volume to 60 m<sup>3</sup> when comparing the measurement result to requirements in the Building Code C1-1998. [1,3].

A new updated design guide for concrete-built apartment and terraced houses was published in 2009 [1] to complement the previous guide and to take account of the 60 m<sup>3</sup> receiving room volume limitation. The construction types and details presented later on in Section 7.2.2. are based on this guide.

### 7.2.2. Apartments / flats

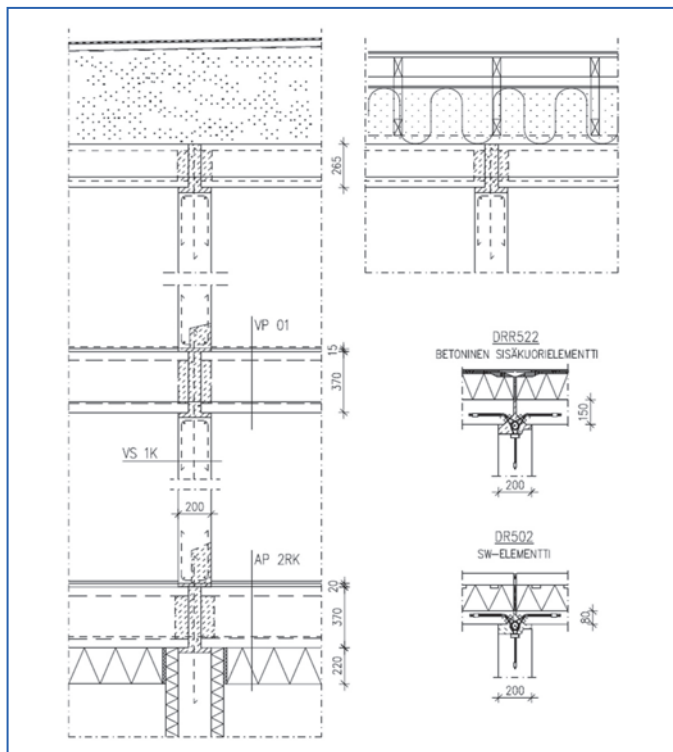
#### *Heavy typical constructions and sound insulation performance*

Figures 7.3 and 7.4 present typical heavy constructions in apartments according to [1].

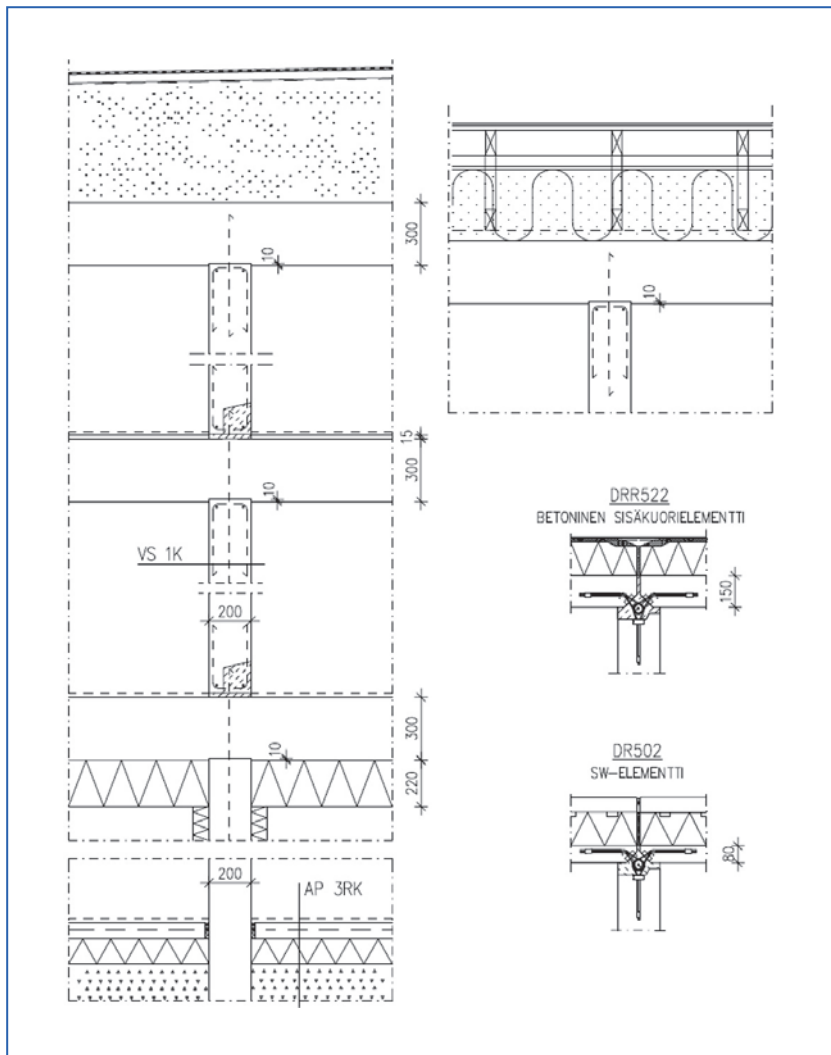
- Structural system in Figure 7.3:
  - Floors: hollow-core slab 370 mm or 270 mm + concrete 50 mm, surface material parquet + Tuplex flexible underlay (or better)



- Roof : hollow-core slab 270, 320 or 370 mm
- Walls (between dwellings and dwelling-corridor) : concrete 200 mm
- Exterior walls : concrete sandwich elements or structure with concrete inner envelope 150 mm
- Structural system in Figure 7.4:
  - Floors: massive concrete slab 260...300 mm, surface material parquet + Tuplex flexible underlay (or better)
  - Roof: massive concrete slab 260...300 mm
  - Walls (between dwellings and dwelling-corridor) : concrete 200 mm
  - Exterior walls: concrete sandwich elements or structure with concrete inner envelope 150 mm



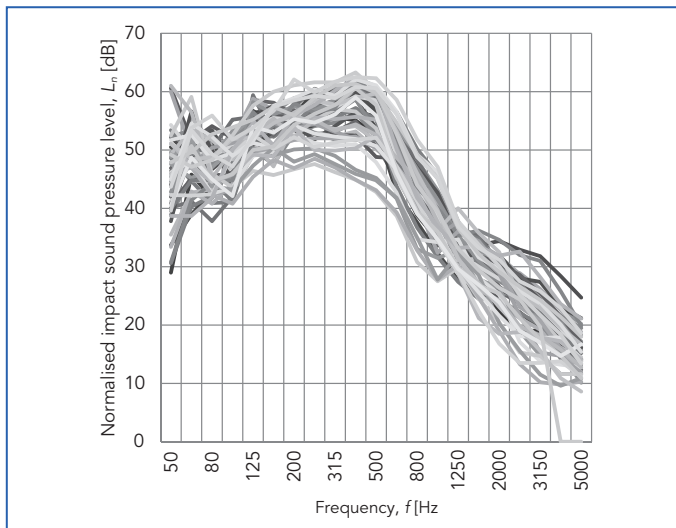
**Figure 7.3.** Structural system in apartments / flats with hollow-core slab as the floor structure [1].



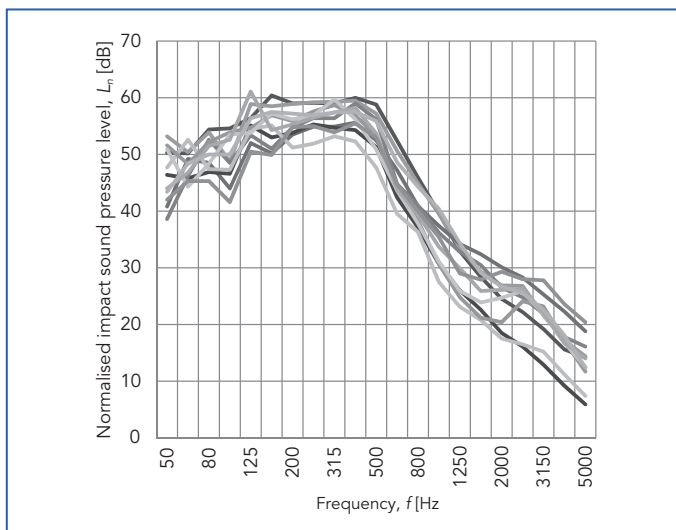
**Figure 7.4.** Structural system in apartments / flats with massive concrete slab as the floor structure [1].

Figures 7.5-7.10 present typical measurement results of impact and airborne sound insulation in apartments in vertical and horizontal direction. Material also includes measurements of structures with defects and deficiencies and does not meet the requirements [4].

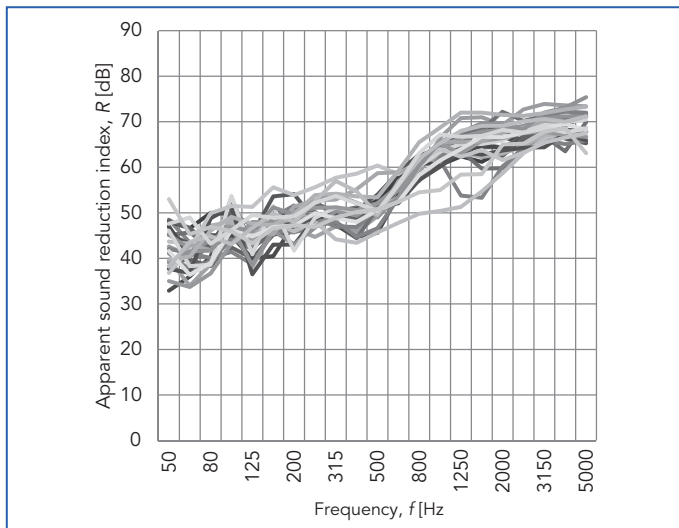




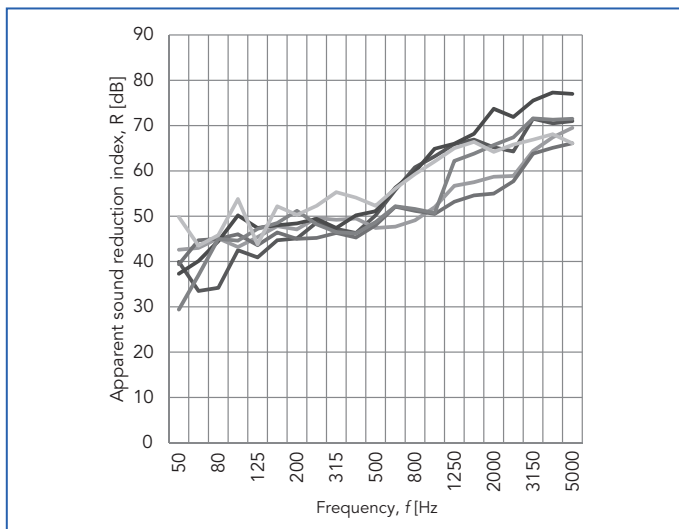
**Figure 7.5.** Typical impact sound insulation in apartments. Measured in vertical direction. Floor: parquet, Tuplex, hollow-core slab + smoothing compound.  $L_{n,w} = 40 \dots 55 \text{ dB}$  [4].



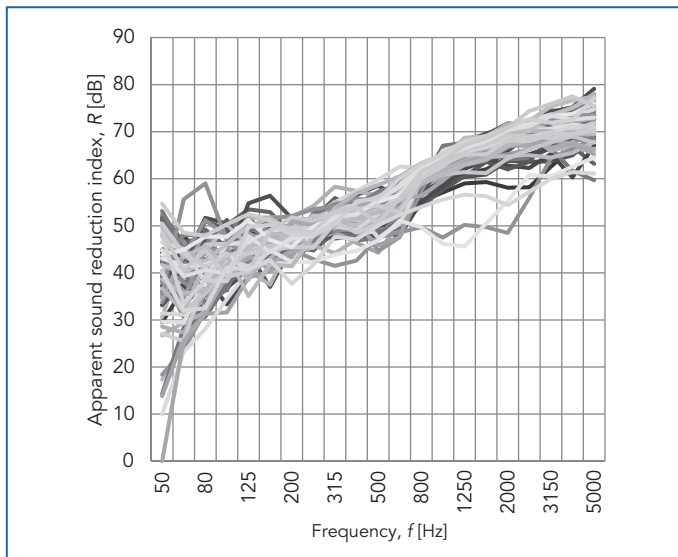
**Figure 7.6.** Typical impact sound insulation in apartments. Measured in vertical direction. Floor: parquet, Tuplex, massive concrete slab + smoothing compound.  $L_{n,w} = 47 \dots 53 \text{ dB}$  [4].



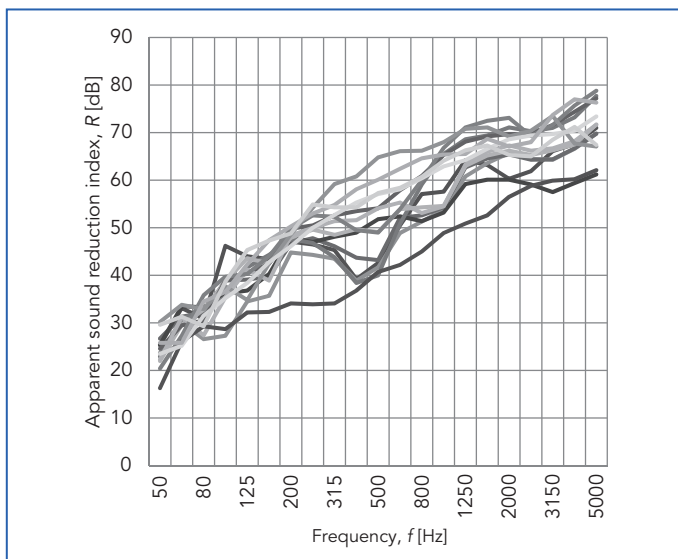
**Figure 7.7.** Typical airborne sound insulation in apartments. Measured in vertical direction. Floor: parquet, Tuplex, hollow-core slab + smoothing compound.  $R_w = 51 \dots 62$  dB [4].



**Figure 7.8.** Typical airborne sound insulation in apartments. Measured in vertical direction. Floor: parquet, Tuplex, massive concrete slab + smoothing compound.  $R_w = 52 \dots 60$  dB [4].



**Figure 7.9.** Typical airborne sound insulation in apartments. Measured in horizontal direction. Wall: concrete 200 mm.  $R_w^* = 49 \dots 63$  dB [4].



**Figure 7.10.** Typical airborne sound insulation in apartments. Measured in horizontal direction. Wall: lightweight structure.  $R_w^* = 45 \dots 62$  dB [4].



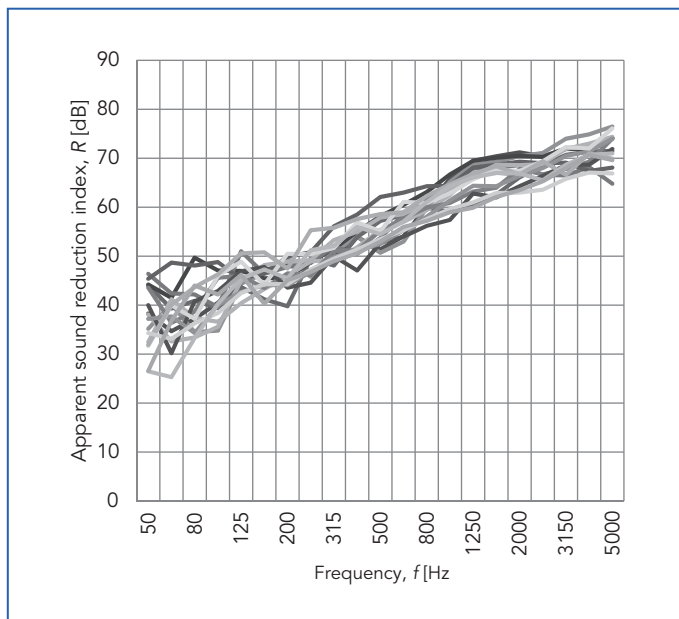
### 7.2.3. Terraced housing

#### Heavy typical constructions and sound insulation performance

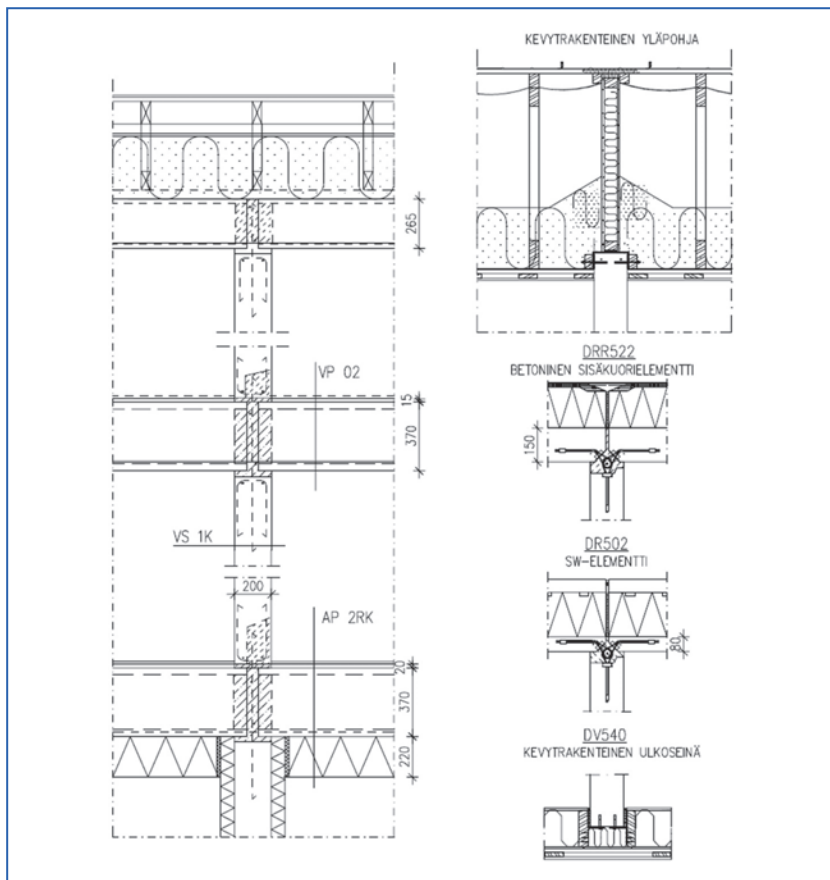
Figure 7.12 presents typical constructions in terraced houses according to [1] with concrete wall between dwellings. Figure 7.11 presents typical measurement results of airborne sound insulation in horizontal direction [4].

Structural system in Figure 7.12:

- Walls between dwellings : concrete 200 mm
- Sub floor: hollow-core slab 370 mm or massive concrete slab 260 mm
- Floor: hollow-core slab 370 mm or massive concrete slab 260 mm
- Roof: hollow-core slab 270, 320 or 370 mm or massive concrete slab 240 mm or lightweight structure
- Exterior walls: concrete sandwich element or structure with concrete inner envelope 150 mm or lightweight structure



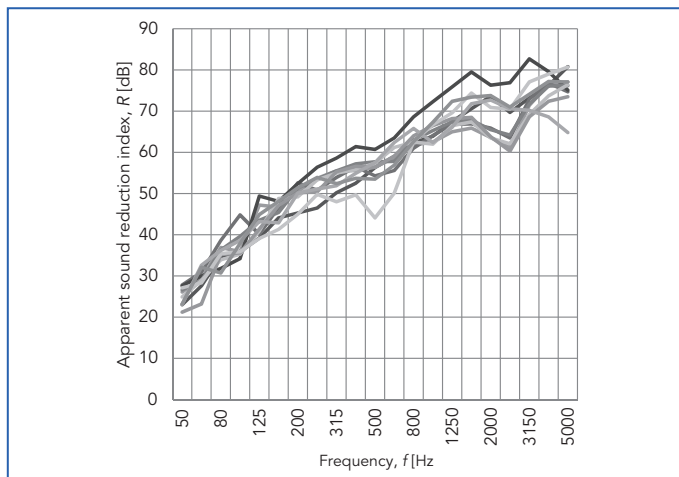
**Figure 7.11.** Typical airborne sound insulation in terraced housing. Measured in horizontal direction. Wall: concrete 200 mm.  $R_w^* = 56 \dots 63$  dB [4].



**Figure 7.12.** Structural system in terraced housing with 200 mm concrete walls between dwellings with adjoining 370 mm hollow-core slabs [1].

### *Lightweight typical constructions and sound insulation performance*

A typical lightweight wall structure used in terraced houses between dwellings is a gypsum board partition with separate studding: 2 x gypsum board 13 mm, studding + mineral wool 70 mm, airspace, studding + mineral wool 70 mm, 2 x gypsum board 13 mm. Usually only the upstairs wall between dwellings is lightweight, while the corresponding wall downstairs is concrete. The structural system is otherwise similar to Figure 7.12. Figure 7.13 presents typical measurement results of airborne sound insulation in horizontal direction [4].

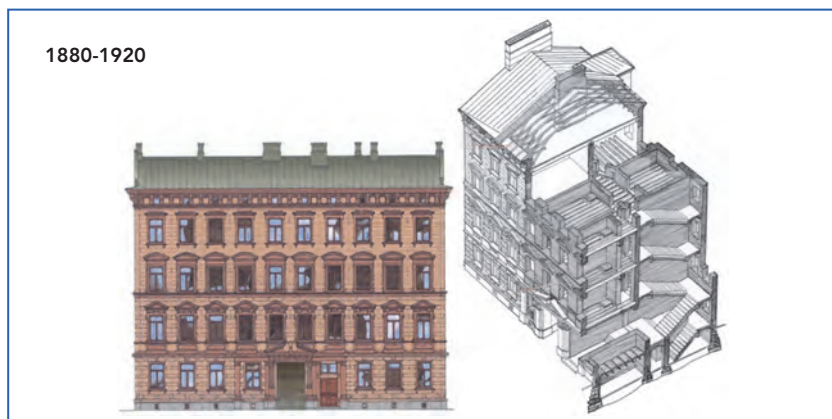


**Figure 7.13.** Typical airborne sound insulation in terraced housing. Measured in horizontal direction. Wall: lightweight structure.  $R_w^* = 55 \dots 65$  dB [4].

## 7.3. Existing housing

### 7.3.1. Typical constructions found in existing stock

Figures 7.14-7.17 present examples of typical apartment houses and their structures from four time periods [5].



**Figure 7.14.** Example of a dwelling constructed in 1891. Left: façade 1:250, right: cross section. Typical structures: floor: wooden structure, walls between dwellings: brick 300...600 mm [5].



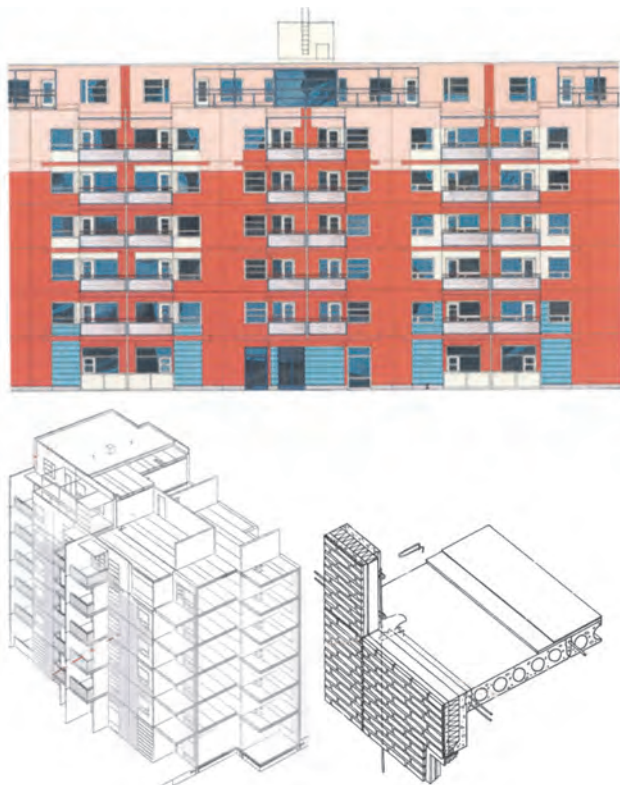
**Figure 7.15.** Example of a dwelling constructed in 1928. Left: façade 1:250, right: cross section. Typical structures: floor: inverted beam, walls between dwellings: double “Lugino mix” wall (an outdated mixture of slag, gypsum, sand and water) [5].



**Figure 7.16.** Example of a dwelling constructed in 1946. Top: façade 1:250, bottom: cross section. Typical structures: floor: inverted beam, walls between dwellings: “Riksi-board” wall (an outdated mixture of woodchips and gypsum) [5].



1975-2000



**Figure 7.17.** Example of a dwelling constructed in 1986.  
 Top: façade 1:250, bottom left: cross section, bottom right:  
 junction between exterior wall (concrete sandwich element)  
 and floor (hollow-core slab 265 mm). Typical structures: floor: hollow-core  
 slab 265 mm, walls between dwellings: concrete 180 mm [5].

### 7.3.2. Sound insulation performance of typical constructions

Tables 7.2-7.4 present measurement results of the apparent weighted sound reduction index  $R'_w$  (vertical and horizontal direction) and the normalised weighted impact sound pressure level  $L'_{n,w}$  in Finnish dwellings in a time range of 1955-2008 [6].





**Table 7.2.** Apparent weighted sound reduction index  $R'_w$  between dwellings in horizontal direction; number of measurement results, averages and standard deviations, requirements and number of results satisfying the requirements [6].

Time range	Number of results	$R'_w$ average	$R'_w$ standard deviation	Requirement ( $R'_w$ )	Percentage of results satisfying the requirement
1955-59	21	53,8 dB	4,4 dB	51 dB	81,0 %
1960-67	19	51,8 dB	4,1 dB	52 dB	47,4 %
1967-76	6	52,3 dB	3,3 dB	52 dB	50,0 %
1976-99	22	55,1 dB	2,5 dB	52 dB	91,0 %
2000-08	14	57,4 dB	1,3 dB	55 dB	100,0 %

**Table 7.3.** Apparent weighted sound reduction index  $R'_w$  between dwellings in vertical direction; number of measurement results, averages and standard deviations, requirements and number of results satisfying the requirements [6].

Time range	Number of results	$R'_w$ average	$R'_w$ standard deviation	Requirement ( $R'_w$ )	Percentage of results satisfying the requirement
1955-59	15	54,7 dB	3,1 dB	51 dB	93,3 %
1960-67	–	–	–	52 dB	–
1967-76	22	52,1 dB	4,0 dB	53 dB	63,6 %
1976-99	46	53,9 dB	3,4 dB	53 dB	69,6 %
2000-08	38	57,3 dB	1,9 dB	55 dB	94,7 %

**Table 7.4.** Normalised weighted impact sound pressure level  $L'_{n,w}$  between dwellings in vertical direction. Number of measurement results, averages and standard deviations, requirements and number of results satisfying the requirements [6].

Time range	Number of results	$L'_{n,w}$ average	$L'_{n,w}$ standard deviation	Requirement ( $L'_{n,w}$ )	Percentage of results satisfying the requirement
1955-59	21	57,1 dB	4,7 dB	62 dB	85,7 %
1960-67	66	55,0 dB	4,3 dB	56 dB	65,2 %
1967-76	33	57,5 dB	6,1 dB	58 dB	45,5 %
1976-99	20	55,4 dB	3,7 dB	58 dB	85,0 %
2000-08	127	48,8 dB	3,9 dB	53 dB	92,9 %

### 7.3.3. Changes in structures between dwellings

Table 7.5 presents how the thicknesses and surface masses of walls and floors between dwellings in Finland changed from 1955 to 2008. The floor was typically either a massive concrete slab or a hollow-core slab and the

typical wall structure was concrete wall. Floating floor structures, which were commonly used in the 1950s and 1960s, have been omitted from the investigation [6].

**Table 7.5.** Development of thicknesses and surface masses of structures between dwellings [6].

Time range	Walls between dwellings		Massive concrete floors between dwellings		Hollow-core slab floors between dwellings	
	[mm]	[kg/m <sup>2</sup> ]	[mm]	[kg/m <sup>2</sup> ]	[mm]	[kg/m <sup>2</sup> ]
1955-59	167	420	–	–	–	–
1960-67	160	400	150	380	–	–
1967-76	180	450	181	450	–	–
1976-99	176	440	213	530	265	380
2000-08	187	470	300	750	370	510

## 7.4. Recommendations based on research conducted in Finland

352 airborne sound insulation measurements and 305 impact sound insulation measurements (made in years 2009-2013) were selected from Helimäki Acoustics measurement database. In the master thesis the objective was to analyze the differences of the normalized and standardized index numbers and their suitability to the sound insulation measurements of dwellings. The study researched the room acoustics of dwellings by using these measurement results. The study clarified that the reverberation time of a furnished dwelling is 0,5 s regardless of frequency or room volume.

This same study examined the effects of the changing of the sound reduction index to standardized level difference. The effects were studied by using the transmitted sound power level of speech and STI. From these results it was concluded that the level of the present Finnish noise insulation regulations will remain the same when the standardized level difference  $D'_{nT,w}$  set 1 dB higher than the sound reduction index  $R'_w$  [10].

In another master thesis the impact sound insulation measurements of intermediate floors were carried out in the research by using both tapping machine and real impact sound excitations. The real impact sound excitations were produced by walking, ball bouncing and chair moving. For each impact sound produced, psychoacoustics quantities, which describe the sensation created by the sound, were defined.

On the basis of the research the building acoustic quantities presented by the valid and proposed standards does not rate intermediate floors in the same rank order as the psychoacoustic quantities based on real impact sounds.

The results show that there is no linear dependence between impact sound created by walking with socks and building acoustic quantities. The impact sound produced by walking with hard-heeled shoes and chair moving correlated best with the building acoustic quantities [7].

It appears that it's best to standardize measurements to 0.5 seconds. And we need to measure impact sound insulation from 50 Hz to 3150 Hz.

## 7.5. References

- [1] Asuinrakennusten ääniteknikan täydentävä suunnitteluoheje, Rakennustuoteteollisuus RT (Confederation of Finnish Construction Industries), author Helimäki Acoustics, 2009.
- [2] Betonirakenteiden ääniteknikka, Helsinki, Rakennustuoteteollisuus RTTry (Confederation of Finnish Construction Industries), author Helimäki Acoustics, 2000.
- [3] Helimäki H., Huhtala T. Sound insulation criteria and large dimensions in Finnish dwellings, Euronoise 2009, Edinburgh, Scotland 26.-28.10.2009.
- [4] Helimäki Acoustics, data of airborne and impact sound insulation field measurements conducted in Finnish new build houses.
- [5] Kerrostalot 1880-2000 – arkkitehtuuri, rakennustekniikka, korjaaminen, Helsinki, Rakennustieto Oy, 2006.
- [6] Lietzen J., Kylliäinen M. Asuinkekkosten välisen ääneneristyksen kehittyminen Suomessa vuosina 1955-2008. Akustiikkapäivät 2013, Turku 22.-23.5.2013, pp. 123-128, Acoustical Society of Finland, 2013.
- [7] Lietzen J. Evaluation of impact sound insulation of intermediate floors on the basis of different impact sound excitations, Master of Science Thesis, Tampere University of Technology, Master's Programme in Civil Engineering, 2013.
- [8] Official Statistics of Finland (OSF): Dwellings and housing conditions [e-publication].ISSN=1798-6761. Overview 2012, 1. Dwelling stock 2012 . Helsinki: Statistics Finland [referred: 6.1.2014]. Internet: [http://tilastokeskus.fi/til/asas/2012/01/asas\\_2012\\_01\\_2013-10-18\\_kat\\_001\\_en.html](http://tilastokeskus.fi/til/asas/2012/01/asas_2012_01_2013-10-18_kat_001_en.html)
- [9] Official Statistics of Finland (OSF): Building and dwelling production [e-publication]. ISSN=1798-9590. October 2013, Appendix figure 1. Building permits granted for dwellings, variable annual sum . Helsinki: Statistics Finland [referred: 6.1.2014].

Internet: [http://www.stat.fi/til/ras/2013/10/ras\\_2013\\_10\\_2013-12-20\\_kuv\\_001\\_en.html](http://www.stat.fi/til/ras/2013/10/ras_2013_10_2013-12-20_kuv_001_en.html)

- [10] Takala J. Acoustical conditions in Finnish dwellings and measurement method of sound insulation, Master of Science Thesis, Tampere University of Technology, Master's Programme in Civil Engineering, 2013.
- [11] Väestötietojärjestelmä, rekisteritilanne 31.8.2013. Internet: <http://vrk.fi/default.aspx?docid=7675&site=3&id=0>



# Building acoustics throughout Europe

## Volume 2: Housing and construction types country by country

# 8

## France

Authors:

**C. Guigou-Carter<sup>1</sup>**  
**J.-L. Kouyoumji<sup>2</sup>**  
**N. Balanant<sup>3</sup>**  
**J.-B. Chéné<sup>4</sup>**

<sup>1</sup> CSTB, Grenoble, France  
e-mail: [catherine.guigou@cstb.fr](mailto:catherine.guigou@cstb.fr)

<sup>2</sup> FCBA, Bordeaux, France  
e-mail: [Jean-Luc.KOUYOUMJI@fcba.fr](mailto:Jean-Luc.KOUYOUMJI@fcba.fr)

<sup>3</sup> CERQUAL / Groupe QUALITEL, Paris, France  
e-mail: [n.balanant@cerqual.fr](mailto:n.balanant@cerqual.fr)

<sup>4</sup> CSTB, Marne-La-Vallée, France  
e-mail: [jean-baptiste.chene@cstb.fr](mailto:jean-baptiste.chene@cstb.fr)



## CHAPTER

## 8

## France

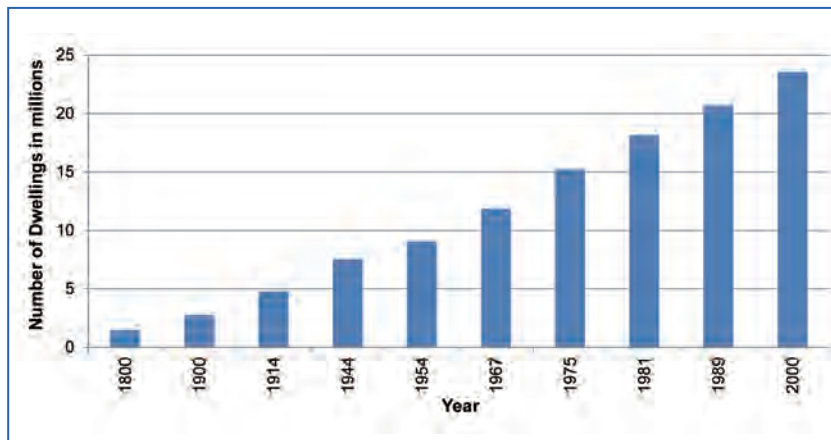
## 8.1. Overview of housing stock

### 8.1.1. Quantities of housing stock and total population

France has approximately 65.8 million inhabitants at the beginning of 2013. At national level the following general information is reported [1]:

- the whole French residential building stock consisted of approximately 14.9 million of buildings in 2000;
- the total amount of dwellings in 2000 was 23.5 million (approximately 10 million flats, 2.8 million attached houses and 10.7 million single family houses);
- the average floor area of a French dwelling is between 70 and 90 m<sup>2</sup> depending on construction year.

In the following Figure 8.1 the number of dwellings per year is reported.



**Figure 8.1.** Number of dwellings per year in France (up to 2000).

Since 2010, the number of new dwellings authorized in France for construction has been decreasing: 19% of decrease between 2010 and 2011, and 8% of decrease between 2011 and 2012 (from 501,170 to 460,034). In 2013, the number of new dwellings is expected to decrease again.

Figure 8.2 shows some examples of generic building types divided per construction period [1]. More information can also be found in [2-4].






Construction Year Class	Additional Classification	SFH Single Family House	TH Terraced House	MFH Multi Family House	AB Apartment Block
... 1800	generic	 FR.N.SFH.01.Gen		 FR.N.MFH.01.Gen	 FR.N.AB.01.Gen
1801 ... 1900	generic	 FR.N.SFH.02.Gen	 FR.N.TH.02.Gen	 FR.N.MFH.02.Gen	 FR.N.AB.02.Gen
1901 ... 1914	generic	 FR.N.SFH.03.Gen	 FR.N.TH.03.Gen	 FR.N.MFH.03.Gen	 FR.N.AB.03.Gen
1915 ... 1944	generic	 FR.N.SFH.04.Gen	 FR.N.TH.04.Gen	 FR.N.MFH.04.Gen	 FR.N.AB.04.Gen
1945 ... 1954	generic	 FR.N.SFH.05.Gen	 FR.N.TH.05.Gen	 FR.N.MFH.05.Gen	 FR.N.AB.05.Gen
1955 ... 1967	generic	 FR.N.SFH.06.Gen	 FR.N.TH.06.Gen	 FR.N.MFH.06.Gen	 FR.N.AB.06.Gen
1968 ... 1974	generic	 FR.N.SFH.07.Gen	 FR.N.TH.07.Gen	 FR.N.MFH.07.Gen	 FR.N.AB.07.Gen

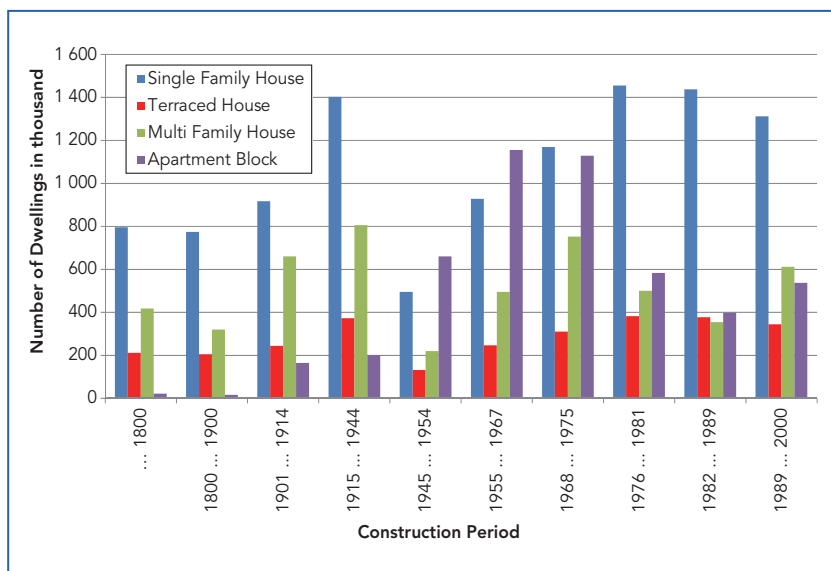
Figure 8.2. Generic buildings types from Tabula project [1].

### 8.1.2. The most populated cities

The most populated cities in France are [5] Paris (2193 thousand), Marseille (852 thousand), Lyon (472 thousand), Toulouse (439 thousand), Nice (347 thousand), Nantes (283 thousand) and Strasbourg (272 thousand).

### 8.1.3. Proportion of dwellings for different building types

Figure 8.3 shows the number of dwellings in France residential buildings by construction period as a function of building type illustrated in Figure 8.2.



**Figure 8.3.** Number of dwellings in residential French buildings by type of building and construction period (up to 2000).

## 8.2. Evolution of French acoustic regulation in numbers

In the following tables (Tables 8.1 to 8.5), the different levels of the French acoustic regulation are presented. An illustration of the actual regulation is given in Figure 8.4.



**Table 8.1.** First recommendations in 1958.

	Sound insulation between dwellings	Sound insulation for outdoor noise	Impact sound insulation	Sound absorbing treatment of common areas	Service equipment noise
Descriptor	$D_{nT}$	$D_{nT}$	$L_{nT}$	–	–
Unit	dB	dB	dB	–	–
Requirement	≥ 30 [100-400] Hz ≥ 45 [400-1600] Hz ≥ 54 [1600-6400] Hz	≥ 15 [100-400] Hz ≥ 20 [400-1600] Hz ≥ 25 [1600-6400] Hz	≤ 66 [100-400] Hz ≤ 61 [400-1600] Hz ≤ 57 [1600-6400] Hz	–	–

**Table 8.2.** First acoustic regulation in 1969.

	Sound insulation between dwellings	Sound insulation for outdoor noise	Impact sound insulation	Sound absorbing treatment of common areas	Service equipment noise
Descriptor	$D_{nAT}$	$D_{nT}$	$L_{nAT}$	–	–
Unit	dB(A)	dB	dB(A)	–	–
Requirement	≥ 51 between living rooms or bedrooms of two dwellings	≥ 15 [100-400] Hz ≥ 20 [400-1600] Hz ≥ 25 [1600-6400] Hz	≤ 70	–	–

**Table 8.3.** Modification of acoustic regulation in 1978.

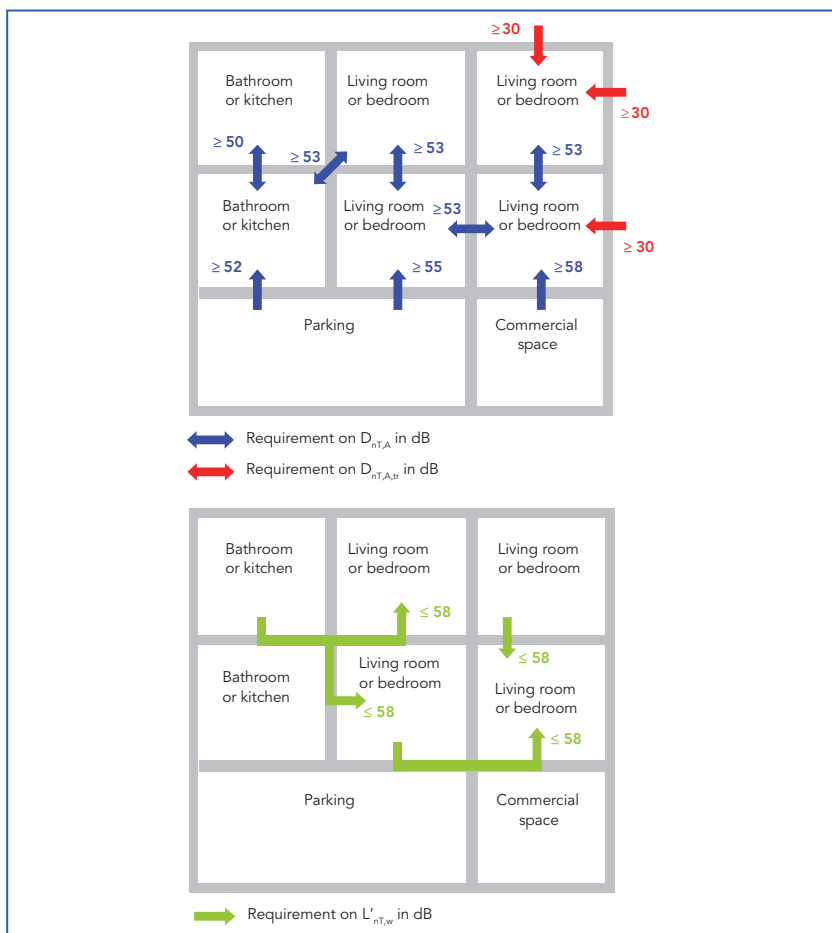
	Sound insulation between dwellings	Sound insulation for outdoor noise	Impact sound insulation	Sound absorbing treatment of common areas	Service equipment noise
Descriptor	$D_{nAT}$	$D_{nAT}$	$L_{nAT}$	–	–
Unit	dB(A)	dB	dB(A)	–	–
Requirement	≥ 51 between living rooms or bedrooms of two dwellings	≥ 30, 35, 42 or 50 depending on outdoor noise level	≤ 70	–	–

**Table 8.4.** New acoustic regulation in 1996.

	Sound insulation between dwellings	Sound insulation for outdoor noise	Impact sound insulation	Sound absorbing treatment of common areas	Service equipment noise
Descriptor	$D_{nAT}$	$D_{nAT}$	$L_{nAT}$	A	$L_{nA,T}$
Unit	dB(A)	dB	dB(A)	m <sup>2</sup>	dB(A)
Requirement	≥ 54 between living rooms or bedrooms of two dwellings	≥ 30, 35, 42 or 50 depending on outdoor noise level	≤ 65	≥ ¼ of floor surface	≤ 35 for ventilation

**Table 8.5.** Modification of new acoustic regulation in 2000.

	Sound insulation between dwellings	Sound insulation for outdoor noise	Impact sound insulation	Sound absorbing treatment of common areas	Service equipment noise
Descriptor	$D_{nT,A}$	$D_{nT,A,tr}$	$L'_{nT,w}$	A	$L_{nA,T}$
Unit	dB	dB	dB)	m <sup>2</sup>	dB(A)
Requirement	≥ 53 between living rooms or bedrooms of two dwellings	≥ 30 or more depending on outdoor noise level	≤ 58	≥ ¼ of floor surface	≤ 30



**Figure 8.4.** Examples of current acoustic requirements for residential buildings.

## 8.3. New build housing constructions

### 8.3.1. Enforced acoustic regulation in residential buildings

In France, the acoustic regulation unchanged since 1996 prescribes the following major requirements for residential multifamily buildings [6-8]:

- façade sound insulation:  $D_{nT,w} + C_{tr} \geq 30$  dB (minimum, but it can be higher depending on the building situation with respect to road, train and airplane noise pollution);
- airborne sound reduction index between dwellings:  $D_{nT,w} + C \geq 53$  dB ;
- impact sound insulation:  $L'_{nT,w} \leq 58$  dB ;
- noise from service equipment:  $L_{nAT} \leq 30$  dB(A);

The requirements given in the French regulation depend on the use of the rooms (kitchen, bathroom, bedrooms, living rooms, etc...) considered (emission and/or reception). It should be noted that a tolerance of 3 dB is allowed on the performance indices measured on site. In the particular case of common hallways, the ratio between the equivalent acoustic absorption area of acoustic treatments and the floor surface area must also meet regulatory limits, depending on the use of the building.

For single family houses (detached houses), only the façade sound insulation and noise from individual equipment requirements are applicable.

Other regulations apply to hotels, educational buildings, healthcare buildings, etc... [9-12].

Since November 2012, a new obligation on the developers of residential buildings (collective or terraced houses) located in France for building permits filed after January 1<sup>st</sup> 2013. In order to improve the acoustic comfort in dwellings and reduce the rate of non-compliance, 30 May 2011 decree and its implementing order of 27 November 2012 concerning the certificate of recognition of the acoustic regulations empower developers and contractors in relation to the sound regulatory phases of design, implementation and acceptance of the building. This certificate can only be issued by a person who can demonstrate competence in acoustics. For the residential buildings of over 10 dwellings, acoustic measurements are mandatory after the building completion.

### 8.3.2. *Typical heavyweight constructions*

The most common building typologies consist of heavyweight constructions, although also lightweight constructions are developing in the recent years.

The repartition is about 10% of terraced houses and 90% multi-dwelling buildings.

In the case of multi-dwelling buildings, 50% of them use interior thermal insulation, 42% have external thermal insulation, 6% have thermal insulation integrated in wood frame structures and 2% have self-insulated walls (hollow bricks or aerated concrete blocks for example). When using interior thermal insulation, 69% of the buildings are concrete based, and the remaining part, brick based. When using exterior thermal insulation, 95% of the buildings are concrete based, and the remaining part has self-insulated walls.

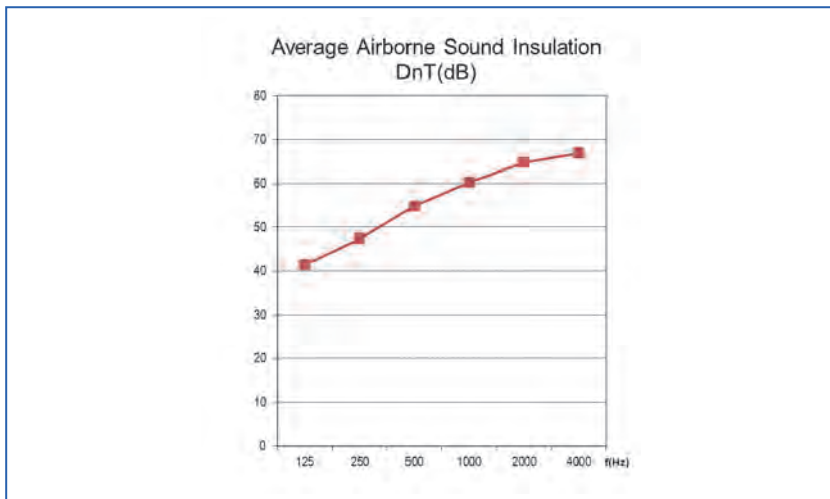
In the case of terraced houses, 62% of them use interior thermal insulation, 23% have external thermal insulation, 12% have thermal insulation integrated in wood frame structures and 3% have self-insulated walls (hollow bricks or aerated concrete blocks for example). When using interior thermal insulation, 25% of the buildings are concrete based, and the remaining part has self-insulated walls. When using exterior thermal insulation, 75% of the buildings are concrete based, and the remaining part has self-insulated walls.

In the case of multifamily buildings, 100% of them have a ground floor slab made of concrete; intermediate floors are 98% made of concrete and 2% wood based.

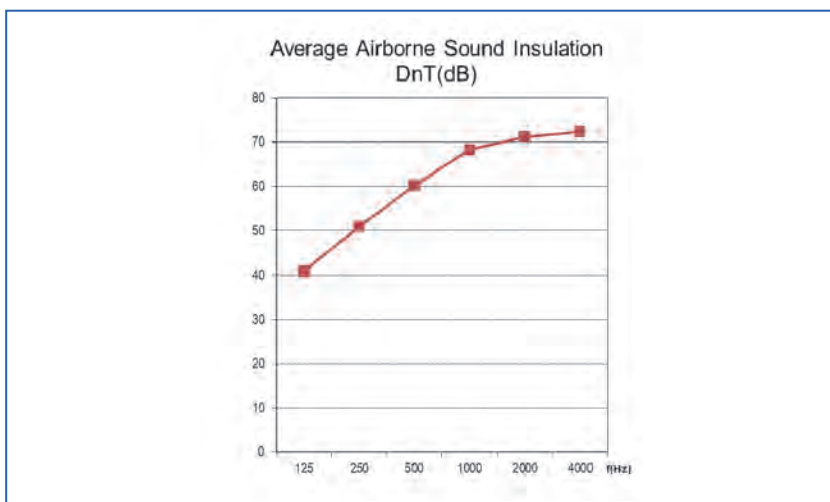
In the case of terraced houses, 100% of them have a ground floor solid concrete slab; intermediate floors are 65% composed of solid concrete slabs, 27% wood based and 8% beam and block floors with concrete topping.

### 8.3.3. *Typical lightweight wood based constructions*

Lightweight wood based constructions are increasing in terraced houses as well as in multi-family buildings. The floors are composed of wood joists with a suspended ceiling including mineral wool and a floating covering (either dry or humid type); the separating walls are in general double wood frame walls with bracing boards either inside or outside the double walls; insulating material is used between the studs. The façades are single wood frame walls with thermal insulation between the studs; exterior or interior thermal insulation can also be applied. Cross laminated timber construction for multi-family buildings is also developing.



**Figure 8.5.** Averaged sound insulation spectrum of 59 consistent in-situ measurements on 59 different heavyweight constructions; Averaged sound insulation rating  $D_{nT,w} + C = 56$  dB.



**Figure 8.6.** Averaged sound insulation spectrum of 11 consistent in-situ measurements on 3 different lightweight constructions; Averaged sound insulation rating  $D_{nT,w} + C = 55$  dB,  $D_{nT,w} + C_{50-3150} = 51$  dB.

### 8.3.4. Examples of housing constructions fulfilling regulation

In order to have buildings fulfilling regulation, different guides are available: “Exemples de solution acoustique” (ESA standing for Acoustic Solution Examples) [13] and “Référentiel Qualitel Habitat & Environnement” [14] which is a reference for new housing certification. It should be added that the requirement for Qualitel acoustic certification are slightly reinforced (especially with respect to impact noise level 55 dB instead of 58 dB). The Qualitel Habitat & Environnement reference proposes three evaluation methods; one of these methods uses comparison with examples of typical technical arrangement that could be in a way related to “robust details” approach. The other two methods correspond to a flat-rate method (based on tables with flat-rate results) and a simplified calculation approach; these two methods only applied to specific walls and floors. For any other cases, it is obviously possible to use the standard series EN 12354 (Building Acoustics — Estimation of acoustic performance of buildings from the performance of elements) to evaluate acoustic performance of a building.

These documents mostly deal with heavyweight construction; a new guide in order to cover lightweight construction should be available in 2014.

An example from the actual version of the 2002 ESA guide [13] is shown in Figure 8.7. This guide is under revision and an updated version should be available at the end of 2013. The proposed constructive solutions are based on product classification depending on their performance; the second part of the guide describes the different product classification. An example of classification for floating floor is given in Figure 8.8.

### 8.3.5. Satisfaction survey regarding housing quality

In 2010, a survey was conducted by Cerqual [15] on buildings constructed between 1990 and 2007; 74% of them were multi apartment buildings. The survey was conducted by phone interviews, 807 in total (57 % female; 61% owned their house or apartment, 57% are the first to live in apartment).

Regarding the global satisfaction regarding their housing quality, 50.5% of the respondents said they were very satisfied, 44% satisfied. For multi-apartment buildings, 6% of the respondents were not satisfied; for buildings constructed between 2005 and 2007, 8% were not satisfied.

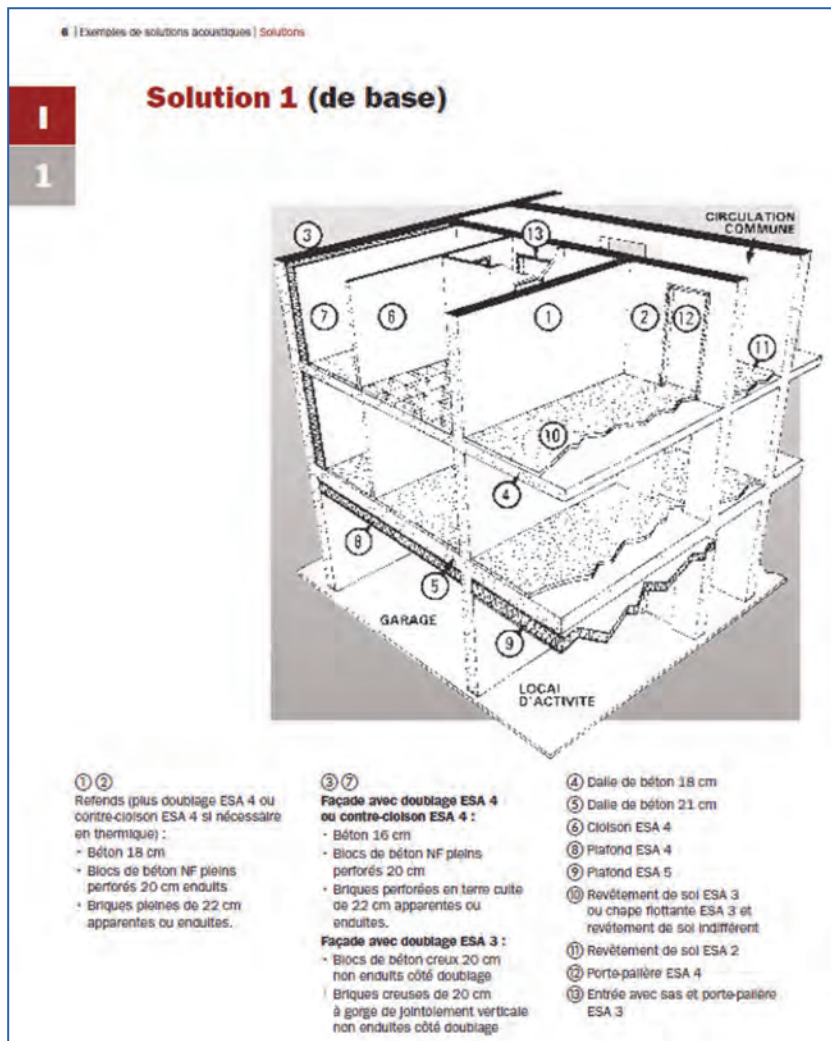


Figure 8.7. Example of building solution from 2002 ESA guide.

Regarding the satisfaction with respect to acoustic comfort, 85% of the respondents were satisfied. The following details were obtained:

- For sound insulation with respect to outdoor noise: 90% of the respondents were satisfied; for 31% of the respondents having noisy outdoor environment, 15% were not satisfied

- Regarding the service equipment noise, 12% of the respondents were not satisfied
- Regarding noise from adjacent dwellings, 20% of the respondents were not satisfied; 69% heard noise from neighbour service equipment, 63% heard neighbours conversation, television or music, and 72% heard neighbour walking
- Regarding noise from common areas: 11% of the respondents were not satisfied; 53% heard noise from building common service equipment, 90% heard people walking or talking in hallways and staircases.

In conclusion, acoustic comfort appears as a very important criterion for satisfaction on global housing quality; its improvement is a priority especially regarding sound insulation between dwellings, noise from service equipment in dwelling and sound insulation from common areas such as hallways and staircases.

Exemples de solutions acoustiques / Produits ou systèmes | 33

## Chapes flottantes

||  
4

La performance du produit au bruit de choc se traduit par l'indice  $\Delta L_{Wc}$ , en dB, défini par la norme NF EN ISO 717-2 et résulte d'une mesure en laboratoire conforme à la norme NF EN ISO 140-8, chape non chargée (Norme NF S 31-053 provisoirement admise).  
 La performance du produit aux bruits aériens se traduit par l'indice  $\Delta(R_{w} + C)$  en dB et résulte d'une mesure en laboratoire (voir annexe AT).

Type	Essai de type de moins de 10 ans <sup>(1)</sup>	
ESA 3	$15 \leq \Delta L_{Wc}$	et $0 \leq \Delta(R_{w} + C)$
ESA 4	$19 \leq \Delta L_{Wc}$	et $\Delta(R_{w} + C) \leq 3$
ESA 5	$22 \leq \Delta L_{Wc}$	et $\Delta(R_{w} + C) \leq 6$

La notion "Essai de type..." suppose que l'essai a été réalisé par un laboratoire accrédité reconnu par le COFRAC, suivant les normes en vigueur.  
 (1) L'essai de type comprend une mesure de  $\Delta L_{Wc}$ , de  $\Delta(R_{w} + C)$  et une mesure de rigidité dynamique  $\sigma'$  de la sous-couche : voir annexe AG.  
 De plus, l'industriel devra s'assurer de la constance de la production des produits mis sur le marché (voir annexe AG). Ceci constitue une mesure transitoire dans l'attente d'un règlement de certification de ses produits.

*Diminué pour obtenir une mise en œuvre conforme : ❌❌❌*

Figure 8.8. Example of product classification from 2002 ESA guide.

### 8.3.6. Typical errors in design and workmanship

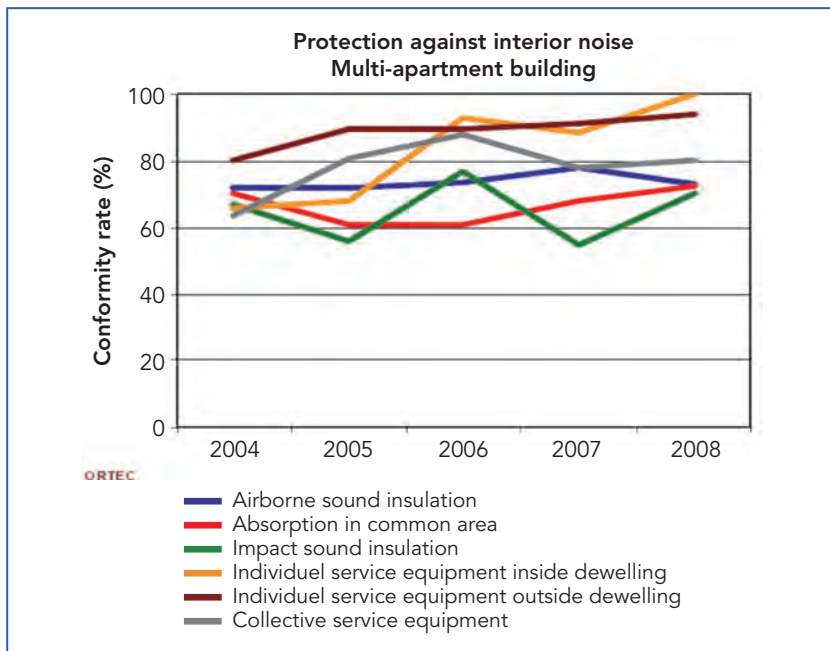
#### Conformity rate with respect to the acoustic regulation

The results presented in this section are data from 2008 ORTEC report [16]. Façade sound insulation requirement are satisfied in about 90% of





the controlled multi-apartment buildings. Figure 8.9 shows that the evolution of the conformity rate for interior noise in multifamily buildings. In 2008, the conformity rate is 70% for airborne sound insulation and 65% for impact noise.



**Figure 8.9.** Evolution of conformity rate for interior noise in multifamily buildings.

When the verification of the acoustic performance is verified following a complaint of residents, the non-conformity is up to

- 40% for airborne sound insulation (between dwellings and between hallways and dwellings),
- 20% for impact noise between dwellings,
- 17% for individual service equipment noise inside the dwellings (mostly mechanical ventilation),
- 67% for service equipment noise from another dwelling (water waste from toilets in majority),
- 25% for airborne sound insulation with respect to outdoor noise (road traffic noise).

The main reasons for non-compliance to regulation are generally design errors, faulty workmanship or inadequate monitoring work.

### *Design errors*

In this section some examples of the most frequent design errors affecting airborne and impact sound insulation are listed.

Airborne sound insulation,

- on the direct path: flocked fibres sprayed under solid concrete slab and formwork or casing on which concrete slab is poured, formwork or sprayed flocking under concrete slab which has a negative  $\Delta R$  in the low to mid frequency range, as well as installing a hard floor covering (such as tiles or laminated floorboards) on a thin resilient layer on a solid concrete slab,
- on the direct path: windows including air inlets and eventually rolling shutters, not selected with the required acoustic performance with respect to mandatory façade sound insulation especially in noisy neighbourhoods (i.e. when there are several external noise sources),
- on the direct path: single plaster board attached to a supporting wall with adhesive mortar dabs introducing an air gap of 20 mm (rather than using a plaster coating, which does not introduce an air gap),
- on flanking transmission: basic interior thermal linings based on standard polystyrene or polyurethane foam; unusable attic space above two dwellings with a single layer of plaster boards as ceiling when separating wall is not extended all the way up to roof.

Impact sound insulation,

- horizontal transmission not considered on the ground floor.

Sound absorption,

- lack of absorbing material in common areas such as hallways, staircases, etc...

### *Workmanship errors*

In this section some examples of most frequent workmanship errors affecting airborne and impact sound insulation are listed.

Airborne sound insulation,

- Mounting windows required for high insulation levels: junction between the walls and window frame (excessive space, insufficient sealing),



installation of the interior lining around the window frame; some examples of problems encountered with mounting windows are shown in Figure 8.10.

- Landing door opening directly on the living spaces: missing joint or wrongly installed, unevenness and squaring defect of the frame, unevenness of door leaf due to stocking in bad conditions.
- Separating wall between dwellings : electric components (light switch, power socket) positioned back-to-back, interior lining mounted continuously between two dwellings.
- Separating floors between dwellings: holes around piping systems (water waste etc...) going through floor slab (see Figure 8.12 for example).

For impact sound insulation,

- Floating floors: poor preparation of supporting slab (evenness, cleanness), poor installation of resilient layer and/or flanking strips (discontinuity), improper placement of skirting boards connecting the floating floor and walls, improper consideration of specific points such as beams, pipes, bottom part of patio door frame.

Some of these errors are illustrated in Figures 8.10 to 8.12.



**Figure 8.10.** Example of problems related to windows.



**Figure 8.11.** Example of problems related to floating floors.



**Figure 8.12.** Example of problems related to piping system going through separating floor slab.

## 8.4. Existing housing

### 8.4.1. Typical constructions found in existing stock

The following analysis regarding acoustics is made from recent documents on the typology of existing residential buildings in France. Only collective residential buildings are considered here. The information obtained was supplemented by other documents found in "Cahier du CSTB" (CSTB publication) for the period considered, and that often gave examples of constructive solutions meeting the recommendations or regulations of the time. However, it is not certain that these examples of constructive solutions have been followed by the developers of the time and other solutions, usually oversized so as not to get in trouble, are certainly present in the housing stock.

#### *Buildings before 1914*

The building envelope (façade vertical walls) is built of local stone, rubble filled or solid clay brick. These walls are thick enough and not thermally insulated by a lining either inside or outside of the façade. The floors are either traditional wood floors, or (from the late 19th century) metallic joists with bricks or plaster as interjoist; a ceiling made of plaster on wood lathing is often present. The internal partitions are often brick based. The openings are carpentry wood type and single glazed with an average ratio of 25%, with the exception of Haussmann buildings that have a higher ratio of 33% (frequent high glass doors and windows).



**Figure 8.13.** Example of buildings from before 1914  
(from [2] and [www.parisbalades.com](http://www.parisbalades.com)).

### *Buildings between 1914 and 1948*

There was little change during this period, except for the outbreak of hollow bricks and the first structures with concrete pillars and beams, and slab including brick or rubble filling. The typical floor was composed of steel beams with brick or plaster blocks as interjoist. The first “modern” buildings with concrete reinforced pillars and slabs started appearing.



**Figure 8.14.** Example of buildings between 1914 and 1948  
(from [2] and [www.parisbalades.com](http://www.parisbalades.com)).

### *Buildings between 1948 and 1968*

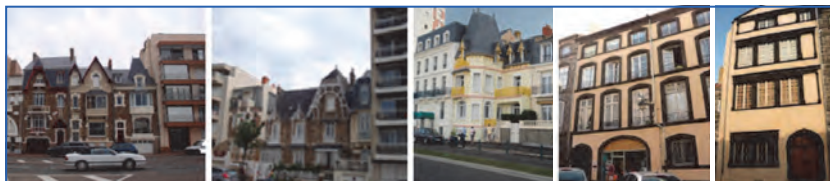
Industrialization was the only way to solve the housing crisis and resulted in the development of heavy precast concrete elements: facade elements, poured vertical walls (which meant the outbreak of loadbearing walls), wide varieties of flooring (reinforced concrete slabs 15cm thick especially for large collective buildings, thinner ribbed reinforced concrete slabs, concrete beam and filler slab floors, floors on metal beams.... All these modular elements were being coordinated in France to set the dimensions of major elements (floor height, length of the floor elements...). It was also the beginning of the normalization of the blocks used in masonry (solid or hollow concrete blocks and hollow bricks, gypsum blocks for partitions).

The thermal insulation of walls was almost absent and was not really used until the early '60s, however, the use a plaster brick inner wall associated to the façade wall spread.



Partitions based on gypsum boards fixed to a supporting frame appeared in the early 50s but were really used in the early 60s.

The first acoustic requirements appeared in technical references for the implementation of the Building Regulations which defined a minimum sound insulation for dwellings in relation to external noise, a minimum sound insulation between dwellings and a maximum level of impact noise generated by the standard tapping machine.



**Figure 8.15.** Example of buildings between 1948 and 1968 (from [2]).

### *Buildings between 1968 and 1974*

The first acoustic regulation in 1969 and examples of building solutions available at the time give a picture of the type of constructions typical of this period (if these examples were followed by the developers):

- Separating floors are reinforced concrete slab floor or beam and block floors with concrete topping ( $350 \text{ kg/m}^2$  or 15 cm thick), with a floor covering (commonly plastic, carpet or parquet); the ceilings were made of plaster on wood lathing including mineral wool in the cavity.
- Separating walls were typically 14 cm concrete walls, 18 cm solid concrete block walls, 22 cm solid brick walls with a plaster coat on both sides; also it was possible to build less heavy walls around  $150 \text{ kg/m}^2$  with a lining including mineral wool.
- Windows: wood frame with single pane glazing (since there was no change in regulation with respect to outdoor noise).

### *Buildings between 1974 and 1981*

The first oil crisis induced the approval of a thermal regulation in 1974, which regulated the use of thermal lining on the inside face of outer walls (mostly expanded and extruded polystyrene, and mineral wool) and double pane windows with aluminum or PVC frame.

The acoustic regulation was modified regarding façade sound insulation requirements.



**Figure 8.16.** Example of buildings between 1968 and 1974  
(from [2] and [www.parisbalades.com](http://www.parisbalades.com)).

### *Buildings between 1981 and 1989*

The second oil crisis induced the approval of a new thermal regulation in 1982, consequently interior thermal linings (thermal insulation combined with a plaster board) were generalized. The use of heavy prefabricated elements decreased due to the decrease in implementation costs of poured concrete and concrete masonry blocks.



**Figure 8.17.** Example of buildings between 1974 and 1981 (from [2]).



**Figure 8.18.** Example of buildings between 1981 and 1989  
(from [2] and [www.parisbalades.com](http://www.parisbalades.com)).

### *Buildings between 1990 and 2000*

The new acoustic regulation of 1996 implied the use of thermo-acoustic elastified polystyrene or mineral wool based linings as façade insulation to minimize flanking transmission, resilient layers for masonry based partition



walls, floor coverings with enhanced acoustic performance, and sound absorbing treatments in common areas of buildings.

For multi-apartment buildings, the building components were generally 20 cm concrete floor slabs with a floating floor on an acoustic resilient layer or a plastic floor finish ( $\Delta L_w = 16$  dB), 16 cm concrete façade walls with interior thermo-acoustic lining and/or external thermal layer, and 18 cm concrete separating walls.

Regarding detached houses, façade is most commonly made of hollow terra cotta bricks.

New façade types appeared in order to fulfill thermal requirements which were becoming more demanding.



*Figure 8.19. Example of buildings between 1990 and 2000 (from [2] and [www.parisbalades.com](http://www.parisbalades.com)).*

## 8.5. References

- [1] Tabula project <http://www.building-typology.eu/> .
- [2] RAGE, Analyse détaillée du parc résidentiel existant, 2012.
- [3] Guide "Amélioration thermique des bâtiments collectifs construits de 1850 à 1974", 2011.
- [4] Pascale Graulière, Typologie des bâtiments d'habitation existants en France – Synthèse des caractéristiques des bâtiments permettant l'évaluation du potentiel d'amélioration énergétique, DHUP report, 2007.
- [5] <http://en.wikipedia.org/wiki/>.
- [6] Arrêté du 30 juin 1999 relatif aux caractéristiques acoustiques des bâtiments d'habitation.
- [7] Arrêté du 30 juin 1999 relatif aux modalités d'application de la réglementation acoustique.
- [8] Circulaire du 28 janvier 2000 relative à l'application de la réglementation acoustique des bâtiments d'habitation neufs.
- [9] Arrêté du 25 avril 2003 relatif à la limitation du bruit dans les établissements scolaires.



- [10] Arrêté du 25 avril 2003 relatif à la limitation du bruit dans les établissements de santé.
- [11] Arrêté du 25 avril 2003 relatif à la limitation du bruit dans les hôtels.
- [12] Circulaire du 25 avril 2003 relative à l'application de la réglementation acoustique des bâtiments autres que d'habitations (explicite les autres arrêtés).
- [13] Exemples de Solutions Acoustiques, 2002 (document under revision, updated version by the end of 2013), available on <http://www.cstb.fr/dae/fr/production-scientifique-et-technique/rapports-publics.html> .
- [14] Référentiel Millésime 2012 Qualitel Habitat&Environnement, Certifications Habitat neuf, 2012, available on <http://www.qualite-logement.org/referentiels-et-documentation/referentiels.html> .
- [15] CERQUAL, Observatoire du fonctionnement du logement, 2010.
- [16] Respect des Règles de Construction – Contrôles 2008 – Part 1 Résultats généraux - France entière, CSTB report, 2010.



# Building acoustics throughout Europe

## Volume 2: Housing and construction types country by country

# 9

## Germany

Authors:  
**Martin Schneider<sup>1</sup>**  
**Andreas Ruff<sup>2</sup>**  
**Heinz-Martin Fischer<sup>3</sup>**

Hochschule für Technik Stuttgart, 70174 Stuttgart, Germany

<sup>1</sup> martin.schneider@hft-stuttgart.de

<sup>2</sup> andreas.ruff@hft-stuttgart.de

<sup>3</sup> heinz-martin.fischer@hft-stuttgart.de



## CHAPTER

## 9

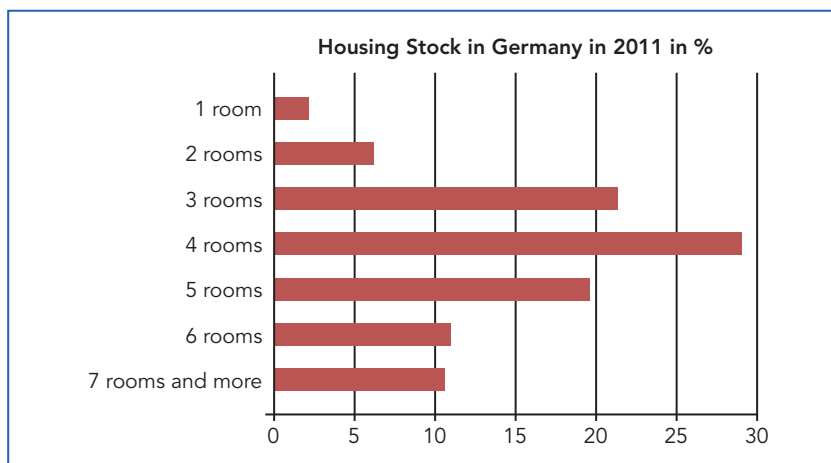
## Germany

## 9.1. Design and acoustic performance

### 9.1.1. Overview of housing stock

The total population in Germany in 2012 was approx. 80,5 Mio. The stock of dwellings increased from 34 Mio (with  $2,8 \times 10^9 \text{ m}^2$ ) in 1991 to 40,4 Mio dwellings (with  $3,5 \times 10^9 \text{ m}^2$ ) in 2011. 46 % of the dwellings are occupied by an owner. 28% of this households live in detached houses. 80 % of the dwellings are build before 1991 (older than 20 years). 27 % of them state that there is annoyance due to noise.

In average people in Germany have a net dwelling area per person of  $43 \text{ m}^2$ . The average living area of a dwelling is  $86,9 \text{ m}^2$ . Rented flats have an average area of  $70 \text{ m}^2$ , self owned flats have an area of  $119 \text{ m}^2$ . The distribution of rooms in the dwellings is shown in the following figure 9.1. In table 9.1 the six most populated cities in Germany are listed. In table 9.2 the total and new build dwellings and the dwelling area in the last four years in Germany are listed.



**Figure 9.1.** Dwelling Stock in Germany in 2011.

Source: © Statistisches Bundesamt, Wiesbaden 2013 [1].

**Table 9.1.** The 6 most populated cities in Germany.

	Population	Area [km <sup>2</sup> ]
Berlin	3.375.222	891,75
Hamburg	1.734.272	755,30
München	1.388.308	310,70
Köln	1.024.373	405,17
Frankfurt am Main	687.775	248,31
Stuttgart	597.939	207,35

Source: (Wikipedia).

**Table 9.2.** Total and new build dwellings and the dwelling area in the last four years in Germany.

		2009	2010	2011	2012
Dwellings (total)	number	158.987	159.832	183.110	200.466
Dwelling area (total)	1.000 m <sup>2</sup>	18.829	19.018	21.664	23.260
Dwellings new build	number	109.053	111.330	125.022	128.458
Dwelling area (new build)	1.000 m <sup>2</sup>	16.087	16.415	18.898	20.475

Source: © Statistisches Bundesamt, Wiesbaden 2013.

## 9.1.2. New build housing constructions

### Acoustic regulations for buildings

For buildings minimal acoustic requirements are stated in the Standard DIN 4109 - 89 [3]. The requirements are fulfilled when the construction achieves the requirements using the calculation procedure according to DIN 4109, Beiblatt 1 [2]. In this calculation procedure there is a safety margin of 2 dB given. In the rare case of acoustic measurements, the requirements have to be fulfilled in all room combinations where measurements were carried out.

The following pictures show typical semi-detached houses, row houses and multi-family houses in Germany.

In Table 9.3 the minimal requirements for airborne and impact sound in multi-family houses according to the German Standard DIN 4109 are listed.



semi-detached house

row houses

**Figure 9.2.** Semi-detached house, row houses and multi-family houses in Germany.  
Source: [www.kalksandstein.de](http://www.kalksandstein.de).

**Table 9.3.** Requirements for partitions in multi-family houses.

Partitions in multifamily dwellings	min $R'_w$ [dB]	max $L'_{n,w}$ [dB]
walls separating apartments	53	
floors separating apartments	54	53
stairs		58
Doors between stairway and hall	27	
Doors between stairway and living room	37	



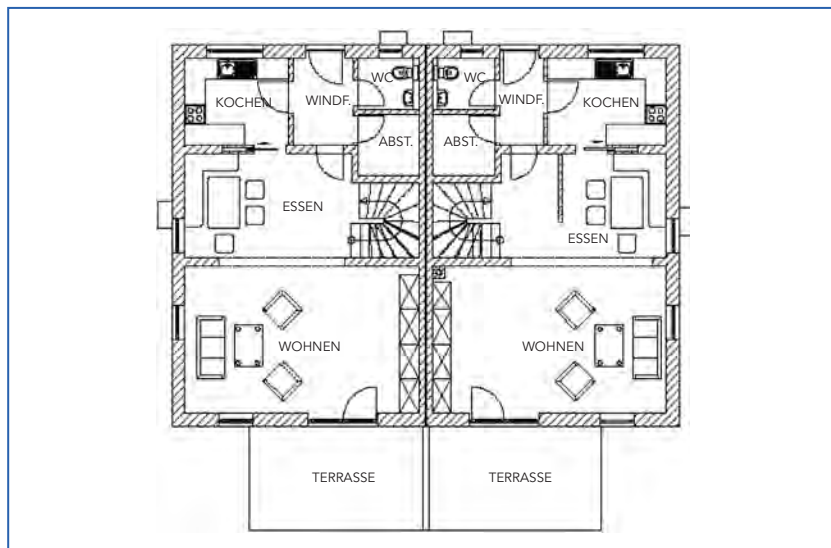
In Table 9.4 the minimal requirements for airborne and impact sound in semi-detached and row houses according to the German Standard DIN 4109 are listed.

**Table 9.4.** Minimum requirements for semi-detached and row houses.

	min $R'_w$ [dB]	max $L'_{n,w}$ [dB]
walls separating houses	57	
floors (transmission across the houses)		48
stairs (transmission across the houses)		53

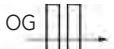
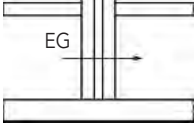
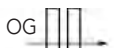
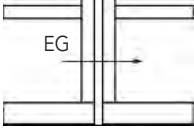
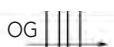

### 9.1.2.1. Terraced housing

Typical new terraced houses have cavity walls made from masonry. Mainly Calcium Silicate, AAC- or lightweight concrete blocks and bricks are used. The surface mass of the two walls ranges from  $m' = 100$  to  $300 \text{ kg/m}^2$  (each). The cavity is typically between 30 and 50 mm and filled with mineral wool. The cavity has to separate all flanking elements (floors, outer- and inner flanking walls). Depending on the type of construction the following increase in sound insulation is given.



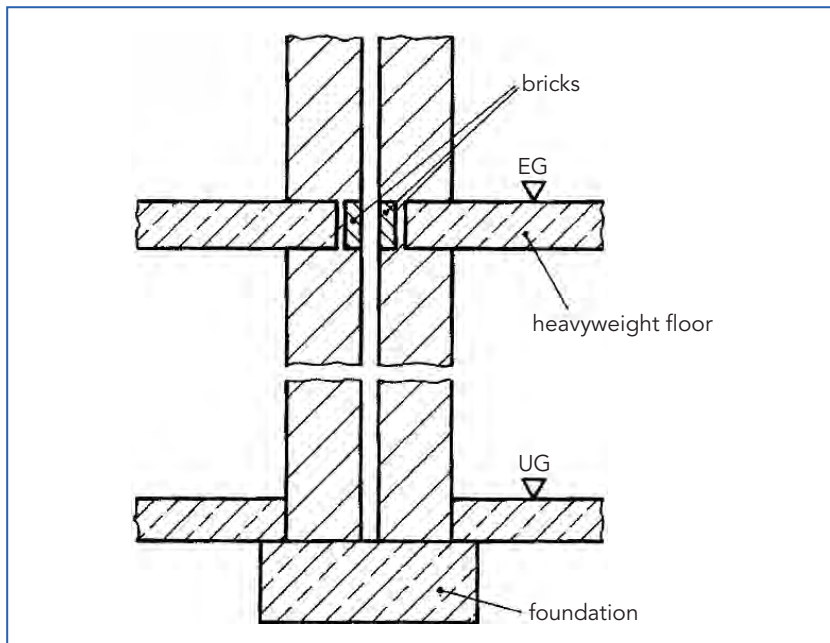
**Figure 9.3.** Ground plan (ground floor) of a typical semi-detached house in Germany.

In Figure 9.4. the addition in sound reduction due to the construction of the cavity wall at the foundation is listed.

Zeile	Situation	Beschreibung	Zuschlag $\Delta_{Rw,Tr}$ in dB
1a		vollständige Trennung der Schalen	12
1b		Bodenplatte durchgehend, $m' \geq 575 \text{ kg/m}^2$ Außenwände getrennt	6 (d)
2a		vollständige Trennung der Schalen	12
2b		Bodenplatte getrennt Außenwände getrennt	9
3a		vollständige Trennung der Schalen	12
3b		Bodenplatte getrennt, Fundament gemeinsam Außenwände getrennt	6 (d)

**Figure 9.4.** Increase in the sound reduction index due to the decoupling of the two heavyweight walls when there is no cellar. (1a: total detachment of the walls; 1b: traversing ground plate, external walls detached; 2a: total detachment of the walls; 2b: ground plate and external walls detached; 3a: total detachment of the walls; 3b: detachment of the ground floor and walls; common foundation).

Source: E DIN 4109-2, 2013 [4].



**Figure 9.5.** Detail of the cavity in a cavity wall construction according to DIN 4109-89, Beiblatt 1. [2]

To prevent sound transmission across the cavity by the roof the construction of the roof cavity detail has to be adequately.

The vast majority of terraced houses are built with heavyweight constructions. Lightweight constructions offer a great variety of different layouts.

Typical errors are due to too small cavities with sound bridges due to bad workmanship, especially in the range of the face side of the concrete floor in the cavity.

Further inappropriate roof constructions (continuous thermal insulation layer made of EPS or PU) may reduce the SRI beneath the roof.

#### 9.1.2.2. Apartments/flats

New multi-family-houses are typically built with masonry and heavyweight reinforced concrete slabs (thickness approx. 200 mm). Usually the slabs have a floating floor to reduce the impact sound transmission. The external walls of the buildings are either made of lightweight homogeneous masonry, e.g.



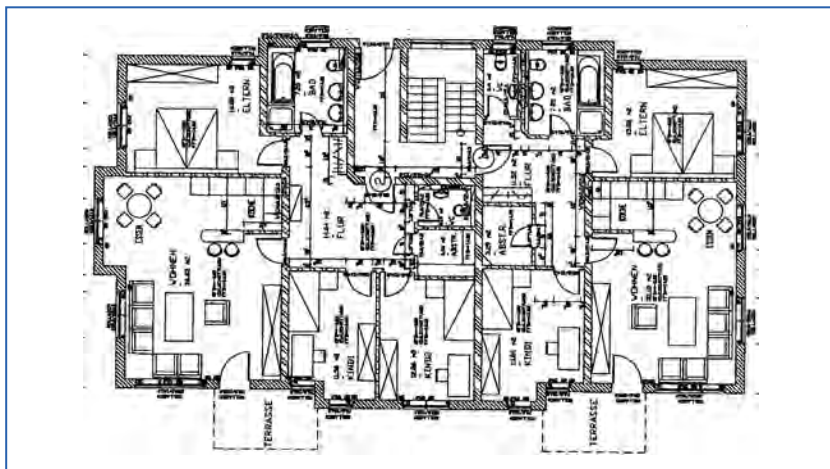


bricks or porous concrete, or with heavyweight masonry, e.g. calcium silicate, with an additional thermal insulation on the outside of the wall. Generally, it is necessary to fulfil regulations of the permitted thermal transmission coefficient. This fact has an important influence on the complete building construction.

The separating walls between different apartments are normally single-leaf heavyweight constructions, e.g. calcium silicate, concrete-filled bricks or sometimes homogeneous concrete, with a minimum mass per unit area of  $480 \text{ kg/m}^2$  to fulfil the acoustical requirements.

The internal walls of a flat (without static requirements) are typically made of lightweight masonry, decoupled gypsum blocks or sometimes plasterboard constructions. This is due to the fact that the German standard DIN 4109 has no requirements of the sound insulation between different rooms of a flat.

In many multi-family-houses the ground plans of the different storeys are quite similar or even identical. By this reason there are many vertical cross junctions between the internal walls and the separating slabs. Between external walls and the slabs are T-junctions. In both cases the flanking transmission has to be considered. According to the used (wall) material the vibration reduction index  $K_{ij}$  in- or decreases and influences the flanking transmission. Further typical acoustical problems in multi-storey buildings can be caused by technical equipment, for example elevators.



**Figure 9.6.** Ground plan (ground floor) of a typical 3 storey apartment house in Germany.

## 9.2. References

- [1] Statistisches Bundesamt, statistical almanac 2013.
- [2] Supplement 1 to DIN 4109, sound insulation in buildings; construction examples and verification methods, Nov 1989, Beuth Verlag Berlin.
- [3] DIN 4109, sound insulation in buildings; requirements and verifications, Nov 1989, Beuth Verlag Berlin.
- [4] E DIN 4109-2, sound insulation in buildings - Part 2: Verification of compliance with the requirements, November 2013, Beuth Verlag Berlin.



# Building acoustics throughout Europe

## Volume 2: Housing and construction types country by country

# 10

## Greece

Author:  
**Konstantinos Vogiatzis**

Ass. Professor  
Transportation Noise - Environmental & Land Use Planning  
Head Laboratory of Transportation Environmental Acoustics (L.T.E.A.)  
Faculty of Civil Engineers - University of Thessaly  
e-mail: kvogiatz@uth.gr



## CHAPTER

## 10

## Greece

## 10.1. Design and acoustic performance: Greece

## 10.1.1. Overview of housing stock

This chapter presents an overview of the housing stock in Greece, based on data from the Hellenic Statistical Authority (NHSS - ESYE). Greece has a total population of approximately 11 million inhabitants (2001) presented by gender and age groups in the following table [1].

**Table 10.1.** De facto population of Greece by gender and age groups.

	Both genders							
	Total	0-14	15-24	25-39	40-54	55-64	65-79	≥ 80
<b>Greece Total</b>	<b>10.964.020</b>	1.664.085	1.565.320	2.509.011	2.188.585	1.205.479	1.500.974	330.566

Males							
Total	0-14	15-24	25-39	40-54	55-64	65-79	≥ 80
<b>5.427.682</b>	858.763	819.623	1.274.633	1.083.251	571.677	685.534	134.201

Females							
Total	0-14	15-24	25-39	40-54	55-64	65-79	≥ 80
<b>5.536.338</b>	805.322	745.697	1.234.378	1.105.334	633.802	815.440	196.365

The new building data for 2012 are shown in table 10.2 [2].

**Table 10.2.** New built properties, storeys, volume, surface and value thereon, Year 2012.

	Number	Storeys (building floors )	Volume (m <sup>3</sup> )	Surface (m <sup>2</sup> )	Value (€)
<b>Greece Total</b>	9.066	15.158	9.577.553	2.641.200	128.614.813

The main categories of the Hellenic building stock according to end use of the buildings are: dwellings, hospitals, hotels, schools and offices/commercial buildings (Figure 10.1). There are also other uses including

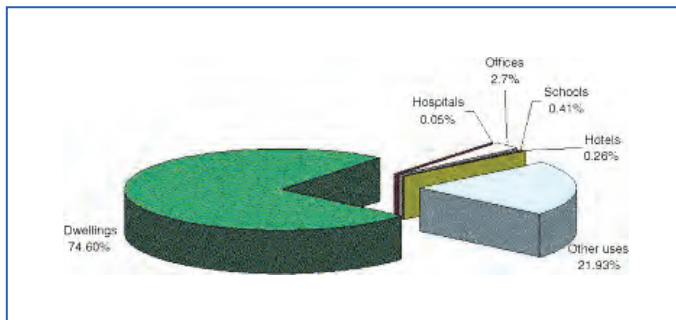
industrial buildings, churches, athletic facilities, storage areas, closed parking spaces, etc., which account for 21.9% of the total stock, the majority of which have periodic use and a limited overall contribution to the total energy consumption. Residential buildings account for about 75% of the Hellenic building stock [3].

The number of permanent residential buildings and permanent dwellings (SD or AB) and their floor area for each of 24 residential buildings categories are given in Table 10.3. The data was estimated based on the available information from the results of the 1990 census the construction activities after 1990, and the assumptions presented above [3], [4], [5].

**Table 10.3.** *Distribution of the Hellenic residential building stock for the 24 categories, for different types of buildings, construction periods and climatic zones.*

Climatic zones	Single dwellings (SD)			Apartment buildings (AB)		
	Number of permanent buildings	Number of permanent dwellings	Floor area (m <sup>2</sup> )	Number of permanent buildings	Number of permanent dwellings	Floor area (m <sup>2</sup> )
<b>Pre-1980</b>						
<b>Greece (total)</b>	<b>1.371.642</b>	<b>1.572.664</b>	<b>133.676.473</b>	<b>194.667</b>	<b>1.147.799</b>	<b>74.606.924</b>
Zone A	256.126	282.479	24.010.738	14.815	45.960	2.987.390
Zone B	589.178	696.732	59.222.241	134.423	809.102	52.591.634
Zone C	471.650	532.359	45.250.489	42.918	284.617	18.500.091
Zone D	54.688	61.094	5.193.004	2.511	8.120	527.809
<b>(1981–2001)</b>						
<b>Greece (total)</b>	<b>450.724</b>	<b>532.422</b>	<b>73.436.924</b>	<b>91.443</b>	<b>639.759</b>	<b>65.725.857</b>
Zone A	101.543	118.755	16.535.476	10.851	60.990	6.309.271
Zone B	187.005	223.939	30.665.932	51.239	376.864	38.614.093
Zone C	141.938	166.755	23.051.218	27.375	189.739	19.554.006
Zone D	20.237	22.973	3.184.299	1.978	12.167	1.248.487
<b>(2002–2010)</b>						
<b>Greece (total)</b>	<b>278.351</b>	<b>337.901</b>	<b>50.685.145</b>	<b>81.297</b>	<b>552.593</b>	<b>60.785.250</b>
Zone A	76.012	88.174	13.226.145	9.591	55.629	6.119.221
Zone B	99.873	124.842	18.726.225	44.862	318.521	35.037.293
Zone C	88.118	108.385	16.257.744	25.080	168.033	18.483.636
Zone D	14.348	16.500	2.475.032	1.764	10.410	1.145.100

The available NHSS data including the percentage of dwellings with: insulation (i.e. insulated roof, external walls, pilotis), are presented in the following table [6].



**Figure 10.1.** Breakdown of the Hellenic building stock according to the end use of the buildings for 1990 [4].

**Table 10.4.** Number of residential buildings for different subcategories with common characteristics.

Subcategories	Single dwellings (pre-1980)	Apartment buildings (pre-1980)	Single dwellings (1980–2001)	Apartment buildings (1980–2001)	Single dwellings (2002–2010)	Apartment buildings (2002–2010)
Total building stock	1.371.642	194.667	450.724	91.443	278.351	81,297
Buildings without or inadequate external wall insulation	1.371.642	194.667	74.491	12.314	–	–
Buildings without or inadequate roof insulation	1.056.164	149.894	18.623	3.079	–	–

Figure 10.2 shows some examples of generic building typology divided per construction period [7].

### 10.1.2. New housing constructions

#### Regulations and requirements

The first Hellenic Building Thermal Insulation Regulation (HBTIR) (OHJ 362/4-7-79) took effect in 1980 setting the minimum requirements for thermal conductivity of the building envelope for different climatic zones. As per the acoustic insulation criteria the MD 2046/304/89 concerning the Building regulation article 12 is still in pending status and a new regulation is under evaluation by the Ministry of the Environment. The isolation criteria as per the above MD are presented in table 10.5 hereafter.

























Country	Region	Construction Year Class	Additional Classification	SFH Single Family House	TH Terraced House	MFH Multi Family House	AB Apartment Block
	Zone A (κλιματική ζώνη Α)	...1980	generic	 GR.ZoneA.SFH.01.Gen		 GR.ZoneA.MFH.01.Gen	
	Zone A (κλιματική ζώνη Α)	1981 ...2000	generic	 GR.ZoneA.SFH.02.Gen		 GR.ZoneA.MFH.02.Gen	
	Zone A (κλιματική ζώνη Α)	2001 ...	generic	 GR.ZoneA.SFH.03.Gen		 GR.ZoneA.MFH.03.Gen	
	Zone B (κλιματική ζώνη Β)	...1980	generic	 GR.ZoneB.SFH.01.Gen		 GR.ZoneB.MFH.01.Gen	
	Zone B (κλιματική ζώνη Β)	1981 ...2000	generic	 GR.ZoneB.SFH.02.Gen		 GR.ZoneB.MFH.02.Gen	
	Zone B (κλιματική ζώνη Β)	2001 ...	generic	 GR.ZoneB.SFH.03.Gen		 GR.ZoneB.MFH.03.Gen	
	Zone C (κλιματική ζώνη Γ)	...1980	generic	 GR.ZoneC.SFH.01.Gen		 GR.ZoneC.MFH.01.Gen	
	Zone C (κλιματική ζώνη Γ)	1981 ...2000	generic	 GR.ZoneC.SFH.02.Gen		 GR.ZoneC.MFH.02.Gen	
Country:	In charge:	Charts - Display Indicators:	Display Primary Energy on pages 'Variants':	Assessment of Energy Carriers:	Building:		
Greece (regions)	NQA	standard calculation, not adapted	non-renewable primary energy	European standard value	exemplary existing building		

Figure 10.2.

Buildings constructed before 1980 (pre-1980) correspond to 75% of the total building stock. During the first decade of the above legislation implementation (1980s), the majority of buildings were not properly insulated and only recently new buildings have thermal & acoustic insulation (usually combined) on the load bearing structure. Consequently, the great majority of the Hellenic building stock is not thermally and acoustically insulated, despite the fact that environmental noise levels have increased. In Greece a huge effort regarding the first

round of the delayed noise mapping in urban agglomerations with a population of more than 100.000 inhabitants is now set in motion. Environmental Noise mainly from transportation is the primary source to be taken in to account in building isolation. This environmental noise is regulated by the Ministerial Decision 210474/2012 regarding the determination of the Indicators for the Evaluation of Environmental Noise and the max allowed Limits of the relevant  $L_{den}$  &  $L_{night}$  noise indicators from the operation of transport networks according to the relevant JMD 13586/724 aiming at the harmonization with 2002/49/EC Directive [9].

**Table 10.5.** Isolation criteria according to MD 2046/304/89.

*values in parenthesis are guidelines for buildings of increased acoustic sensitivity (theatre, cinemas, etc.)*

Acoustic protection & isolation criteria Cat A «High acoustic comfort».	Isolation from adjacent space of principal or secondary use Isolation from spaces of common use		Dwelling isolation from adjacent space of common use		Acoustic protection from :			Isolation between spaces (rooms) of the same dwelling	Isolation of a principal space from installation spaces	
	1	2	3	4	1	2	3	7	8	9
Type of building:	$R'_{w,eq}$ dB	$L'_{w,eq}$ dB	$R'_{w,eq}$ dB	$L'_{w,eq}$ dB	$L_{w,eq}$ dB	$L_{w,eq}$ dB	$L_{w,eq}$ dB	$R'_{w,eq}$ dB	$R'_{w,eq}$ dB	$L'_{w,eq}$ dB
Residential & full and/or part time	54	55	-	-	40	40	40	48	60	45
Offices - Commerce	52	60	58	52	40	40	40	-	55	55
Education	57	58	58	52	40	40	40	-	60	45
Health	57	55	58	52	40	40	40	-	60	45
Industry - Peoples gathering	65	40	62	47	40	40	40	-	(65)	(40)
Acoustic protection & isolation criteria Cat B «Normal acoustic comfort».	Isolation from adjacent space of principal or secondary use Isolation from spaces of common use		Dwelling isolation from adjacent space of common use		Acoustic protection from :			Isolation between spaces (rooms) of the same dwelling	Isolation of a principal space from installation spaces	
Type of building:	1	2	3	4	1	2	3	7	8	9
$R'_{w,eq}$ dB	$L'_{w,eq}$ dB	$R'_{w,eq}$ dB	$L'_{w,eq}$ dB	$L_{w,eq}$ dB	$L_{w,eq}$ dB	$L_{w,eq}$ dB	$L_{w,eq}$ dB	$R'_{w,eq}$ dB	$R'_{w,eq}$ dB	$L'_{w,eq}$ dB
Residential & full and/or part time	50	60	-	-	40	40	40	42	55	50
Offices - Commerce	40	65	52	55	40	40	40	-	53	60
Education	50	65	55	55	40	40	40	-	55	50
Health	50	60	55	55	40	40	40	-	53	50
Industry - Peoples gathering	60	45	60	48	40	40	40	-	(62)	(45)

According to the European Directive 2002/49/EC Member States shall ensure Member that no later than 30 June 2007 Strategic Noise Maps (SNM). Furthermore Member States shall adopt the measures necessary to ensure that no later than 30 June 2012, and thereafter every five years, strategic noise maps showing the situation in the preceding calendar year have been made and, where relevant, approved by the competent authorities. Both the above obligation were not yet met by the Greek authorities even though an important project was set in motion in 2011 regarding the totality of all agglomerations in excess of 100 000 persons including those of the 1st & 2nd phases as described in Table 10.6 hereafter:





**Table 10.6.** Greek Urban Agglomerations with population >100.000 persons.

Urban Agglomeration	Population (approx.)
Larisa	115 000
Volos	77 000
Heraklion (incl. Int. airport)	121 000
Chania	60 000
Kerkyra (incl. Int. airport)	33 000
Patras	156 000
Ioannina	64 000
Kavala	59 000
<b>Athens</b> (City centre) & P & N. Psychiko & Filothei municipalities	790 000
Western Athens Area (Peristeri, Ag. Anargyroi, N. Ionia, Galatsi, N. Filadelfia, Chalkidona municipalities)	322 000
Northern Athens Area (Pefki, Maroussi, N.Heraklion, Chalandri, Vrilissia, Metamorfossi municipalities)	230 000
Eastern Athens Area (Ag. Paraskevi, Cholargos, Papagos, Kesariani, Vironas, Zografou, Imittos, Dafni municipalities)	295 000
Southern Athens Area (Tavros, Moshato, Kalithea, P. Faliro, Ag. Dimitrios, N. Smirni municipalities)	340 000
Piraeus (City centre) & Koridallos, Haidari, Nikaia, Rentis, Aegaleo, Ag. Varvara municipalities	505 000
<b>Thessaloniki</b> & Neapolis municipality	410 000
Serres & Kalamaria municipalities (Northern Greece)	165 000

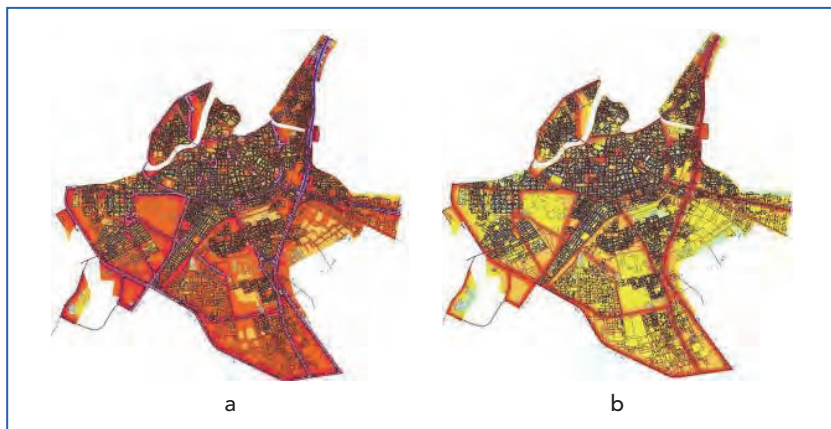
Some of those agglomerations are already in stage of SNM finalization namely the cities of Volos, Larisa, Patras, Herakleion and Chania. However the main and most important agglomerations such as Athens & Thessaloniki are still in bidding phase. The main causes of this delay - quite common in the South European countries - are related to:

- the ongoing economic crisis that prevents the necessary funding availability in several EU member states,
- the availability of concrete data bases regarding traffic and transportation characteristics mainly in urban agglomerations and the secondary & tertiary road network and the building's characteristics
- the complexity of the bidding procedures in the elevated degree of complaints and relevant judiciary actions during the procedure that



prolongs both the period of project final awarding and the beginning of execution (namely in case of Athens and Thessaloniki some 4 years were lost due to similar problems

- inefficiency of the public sector to handle with success and promptly the important task in a national level due mainly to the lack of expertise in both national and local authorities.



**Figure 10.3.** SNM of Larissa urban area: Indices (a)  $L_{den}$  & (b)  $L_{night}$ .

## 10.2. Conclusion

According to the records of the Hellenic National Statistical Service, residential buildings account for about 75% of the total building stock. The great majority of buildings have been constructed before 1980 and, therefore, they are either not acoustically and thermally insulated or poorly insulated; over 60% of exterior walls and 80% of windows of the existing building stock do not meet the minimum requirements. In the last decade there has been some limited improvement, by implementing mainly thermal wall insulation & double - glazed that also improved acoustic insulation as well. It is therefore logical to estimate that:

- Buildings constructed before 1980 (pre-1980), can be considered the border line for buildings without either thermal or acoustic insulation since they were constructed before the implementation of the above regulations
- Buildings constructed during the period 1981– 2000, can be considered to be partially or fully thermally (mainly) insulated with positive effects in

acoustic insulation as well. Despite the introduction of the HBTIR since 1980 and the MD 2046/304/89 since 1989, the integration of thermal and acoustic insulation was problematic during the first decade of its implementation with the acoustic legislation - article 12) still inactive. For example, only recently the new buildings have full thermal & acoustic insulation on the load bearing structure to eliminate thermal & acoustic bridges. Ordinary double glazing is also common practice in all new buildings and the most frequent refurbishment activity in existing buildings

- Buildings constructed after the year 2000 are considered to be fully thermally (mainly) insulated and acoustically insulated in an adequate level. However with the new improved legislation still pending it is rather difficult to enforce a complete building code based on the results of the Strategic Noise Planning still in execution phase

### 10.3. References

- [1] [http://www.statistics.gr/portal/page/portal/ESYE/PAGE-themes?p\\_param=A1604&r\\_param=SAP01&y\\_param=2001\\_00&mytabs=0](http://www.statistics.gr/portal/page/portal/ESYE/PAGE-themes?p_param=A1604&r_param=SAP01&y_param=2001_00&mytabs=0)References should be listed in alphabetical order (and chronological within the same author.)
- [2] [http://www.statistics.gr/portal/page/portal/ESYE/PAGE-themes?p\\_param=A1302&r\\_param=SOP03&y\\_param=2012\\_00&mytabs=0](http://www.statistics.gr/portal/page/portal/ESYE/PAGE-themes?p_param=A1302&r_param=SOP03&y_param=2012_00&mytabs=0)
- [3] Constantinos A. Balarasa, Athina G. Gaglia, Elena Georgopoulou, Sevastianos Mirasgedis, Yiannis Sarafidis, Dimitris P. Lalas European residential buildings and empirical assessment of the Hellenic building stock, energy consumption, emissions and potential energy savings Building and Environment, Volume 42, Issue 3, March 2007, Pages 1298–1314.
- [4] NHSS. Results from the census of constructions-buildings of the December 1, 1990. Athens: National Hellenic Statistical Service; 2000 [in Hellenic].
- [5] NHSS. Statistics of building construction activity for the years 1995 and 1997. Athens: National Hellenic Statistical Service; 2000 [in Hellenic].
- [6] NHSS. Research-energy consumption in households 1987–1988. Athens: National Hellenic Statistical Service; 1993 [in Hellenic].

- [7] <http://webtool.building-typology.eu/webtool/tabula.html>
- [8] [http://www.buildingtypology.eu/downloads/public/docs/scientific/GR\\_TABULA\\_ScientificReport\\_NOA.pdf](http://www.buildingtypology.eu/downloads/public/docs/scientific/GR_TABULA_ScientificReport_NOA.pdf)
- [9] Vogiatzis Konstantinos, Strategic noise mapping in Greece & Cyprus - Some considerations regarding delays and particularities in South European countries from the implementation of the Directive 2002/49/EC, Internoise 2013 - Noise Control for Quality of Life, 15-18 Sept 2013, Innsbruck.



# Building acoustics throughout Europe

## Volume 2: Housing and construction types country by country

# 11

## Hungary

Authors:

**A. B. Nagy<sup>1</sup>**

**G. Józsa<sup>2</sup>**

<sup>1</sup> Budapest University of Technology and Economics, Budapest, Hungary  
e-mail: nagyab@hit.bme.hu

<sup>2</sup> Józsa és társai 2000 Kft., Szeged, Hungary  
e-mail: akusztika@jozsakft.hu



## CHAPTER

## 11

## Hungary

## 11.1. Design and acoustic performance

### 11.1.1. Overview of housing stock

The information given below is based on public data provided by the Hungarian Central Statistical Office (Központi Statisztikai Hivatal [1]) and on partial data available from the National Building Energetics Strategy [2] that is being prepared by ÉMI (Non-profit LLC for Quality Control and Innovation in Building, [3]) and of the Ministry of National Development.

#### *The quantities of housing stock and total population*

The total population of Hungary is approximately 9.9 million inhabitants (according to the census in 2011).

There are 2.6 million residential buildings in the country, containing a total number of 4.2 million inhabited dwellings. Thus the average number of inhabitants per 100 dwellings is 235, however there is a large difference between the capital (215), other cities (251) and the rural area (276).

The average floor area of dwellings is 78 m<sup>2</sup>. Most (43 %) of the dwellings have a floor area between 60 and 100 m<sup>2</sup>, appr. one fourth (26 %) have a floor area of 40–59 m<sup>2</sup>, one fourth (24 %) have a floor area larger than 100 m<sup>2</sup>, whilst 7 % have less than 40 m<sup>2</sup>.

#### *The most populated cities*

The most populated cities are shown in Table 11.1. Only the capital (Budapest) has more than 1 million inhabitants (1.7 million), the second largest city (Miskolc) has only 362 thousand, and there are less than 10 cities with population larger than 100 000.

#### *Proportion of apartments, terraced (row) and detached houses*

According to Eurostat statistics, 63.9 % of Hungary's population is living in detached houses, which is the second highest ratio amongst countries

of the European Union, 30.1 % of population is living in flats (25.7 % in flats in buildings with more than ten dwellings), and 5.4 % in semi-detached houses.

A rough overview on the distribution of the building stock is given in Table 11.2. These data are of a recent survey carried out in 2013 by ÉMI. The category of 'concrete block of flats (panels)' includes all houses that are built of prefabricated, cast concrete blocks and panels, and the category 'traditional flats' includes multi-dwelling houses built with all other construction systems (eg. ceramic bricks).

**Table 11.1.** Most populated cities in Hungary.

City	Population
Budapest	1 735 711
Miskolc	362 905
Debrecen	204 333
Szeged	161 837
Pécs	147 719
Győr	128 567
Nyíregyháza	118 185
Kecskemét	111 863

**Table 11.2.** Distribution of the building stock – overview.

	Detached house	Traditional flats	Concrete block of flats (panels)
<b>Number of buildings</b>	2 527 151	84 825	31 712
<b>Number of dwellings</b>	2 527 151	925 516	703 014

More detailed statistics on the building stock is given in Table 11.3, where the three main building categories are divided into smaller ones according to the year of construction and the walling type.

It is worth noting that (according to statistics from 2011) the total number of adobe (incl. clay and mud and straw) houses is appr. 583 000, whilst the number of wooden houses is only 19 000.

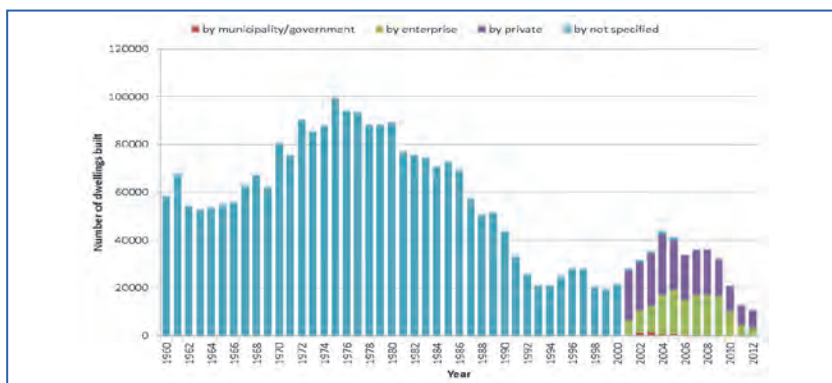
**Table 11.3.** Distribution of the building stock – detailed (2013).

Type	Building type	Constr. date	Walling type	Floor surface	Average floor surface	Nr. of buildings	Of which rowhouse or semi-detached	Nr. of dwellings
1	detached house	until 1944	clay brick, stone, adobe	below 80 m <sup>2</sup>	56	400 537		400 537
2		until 1944	clay brick, stone, adobe	80 m <sup>2</sup> or above	102	269 508		269 508
3		1945-1979	clay brick, stone, adobe	below 80 m <sup>2</sup>	59	449 213		449 213
4		1945-1979	clay brick, stone, adobe	80 m <sup>2</sup> or above	140	672 128	49 533	672 128
5		1980-1989	clay brick, stone, other brick		103	378 942	27 926	378 942
6		1990-2001	clay brick, stone, other brick		110	198 938	2 810	198 938
7		after 2001	clay brick, stone, other brick		132	157 885		157 885
8	multi-family house with 4-9 dwellings	until 2001	clay brick, stone, other brick		365	43 981		258 261
9		after 2001	clay brick, stone, other brick		373	6 285		32 241
10	Multi-family house with 10 or more dwellings	until 1944	clay brick, stone, other brick		1 328	10 819		250 871
11		1945-2001	clay brick, stone, other brick		838	16 825		268 386
12			medium sized or big block, casted concrete		987	10 575		152 567
13		until 1979	panel (concrete)		2 390	11 502		324 617
14		1980-1989	panel (concrete)		1 875	9 635		225 830
15		after 2001	clay or other brick		1 702	3 770		115 757
						<b>2 640 543</b>		<b>4 155 681</b>

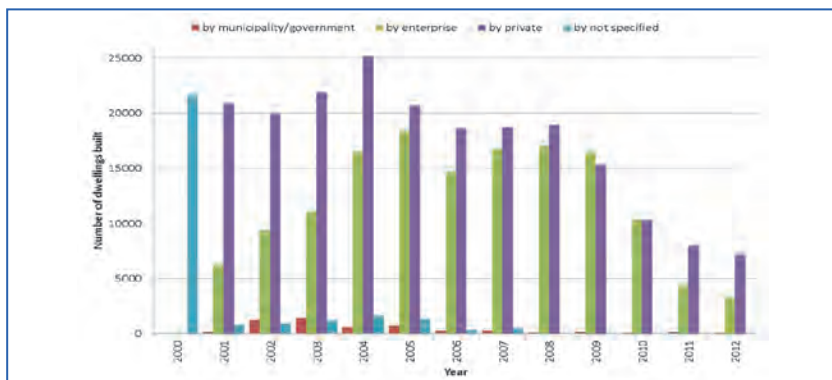


*Typical number of new homes built per year*

The number of new homes built per year is shown in Figures 11.1 and 11.2. For the last decade the data is available broken down to client: if the dwelling was built by the local municipality, or by an enterprise or by a private person. It can be clearly seen that the number of new dwellings has been seriously decreased in the last 3 years. The numbers are in general much lower than during the socialist regime (before 1990), when the constructions were initialized by the government, and many concrete panel buildings (block of flats) were built in order to overcome housing problems. The number of homes built by the municipality has been extremely low in the last years (60 homes in 2012). The data also demonstrates that the global financial crisis of 2007-2008 had no immediate, but a retarded effect on the building industry.



**Figure 11.1.** Number of dwellings built since 1960.



**Figure 11.2.** Number of dwellings built between 2000 and 2012.

### 11.1.2. New build housing constructions

In case of dwellings (homes) in Hungary, most of the constructions are heavyweight; lightweight solutions are not common at present. In some cases the two are combined: lightweight constructions are used mainly for walls inside a dwelling, where the floors and the separating walls (between dwellings or between dwellings and corridors) are heavyweight.

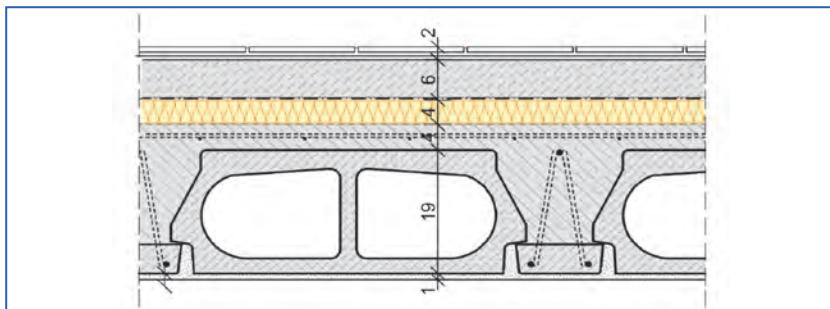
There have been many attempts to save costs by using less expensive, more thin and less heavy materials and systems for separating walls or for floors, but due to the poor acoustical quality the residents did complain and these cases ended up at the court of justice. Larger enterprises and those who already have had cases like this (and yet still exist) have decided to use the appropriate solutions and to force proper and accurate workmanship. Unfortunately many of smaller enterprises still choose to use cheaper solutions with insufficient or uncertain acoustical performance – they disappear right after the construction is finished, so the residents' warranty claim for repair or compensation will never be fulfilled.

#### 11.1.2.1. Typical heavyweight constructions

##### Floors

The most common heavyweight separating floor construction is a beam and block system with floating floor. The height of the beams with the hollow ceramic or concrete blocks is 190 mm, which is covered with 40, 60 or 85 mm thick concrete layer (depending on the design). The impact sound insulation layer is typically 30 mm thick mineral wool or a double layer consisting of a load bearing extruded polystyrene board, a thin insulation foil, and 30 mm thick mineral wool layer. In the latter case the polystyrene layer is used for hiding the pipes (eg. for floor heating). The floating layer is typically 60 mm screed with 5 mm thick PE foam perimeter isolating strip. If the top layer is a laminated floor, it is laid on 3 mm thick felt or PE layer, whereas the ceramic tiling is glued directly onto the screed. The cross-section of this floor is shown in Figure 11.3.

As the properly built floating floor increases the airborne sound insulation by 3-5 dB, the resulting floor construction satisfies both the airborne ( $R'_w + C > 51$  dB) and the impact ( $L'_{n,w} < 55$  dB) sound insulation requirements for the separating floor.



**Figure 11.3.** Cross-section of the most typical heavyweight floor construction, the layers from top to bottom: floor tiling, screed, foil, impact sound insulation layer, beam-and-hollow-block floor system with concrete upper layer, parge coat.

## Walls

The most common solution (at least in the design phase) is to use sand-lime bricks (Silka). For their high density (1400-2000 kg/m<sup>3</sup>) these bricks can be used on their own, without any additional layers (except for plaster) both for separating neighbouring flats from each other and for the corridor. However for these cases slightly different solutions are used, for the sound insulation requirements are different (it is less strict for the corridor-flat connection).

For walls separating the dwelling from the corridor the 200 mm wide HM-200 sand-lime blocks are used (density 1800 kg/m<sup>3</sup>) with 1 cm plaster on both sides. This has a laboratory airborne sound insulation value ( $R_w$ ) 54 dB, which is appropriate for the requirement that is expressed also in laboratory value:  $R_w > 51$  dB.

For walls separating two neighbouring dwellings the heavier, 250 mm wide HM-250 sand-lime blocks are used (density 2000 kg/m<sup>3</sup>), with 1 cm plaster on both sides. In this case the walls should be built on a 4-6 mm thick resilient layer made of agglomerated cork or elasto-cork to avoid rigid joints. The laboratory value of airborne sound insulation of a wall constructed from this brick is 56 dB. With the resilient underlayer the field value is ensured to be above the requirement  $R'_w > 51$  dB, that is expressed in field value in the case for walls separating dwellings.

### 11.1.2.2. Typical errors in design and workmanship

#### Plumbing in service walls

In many cases a service wall (furring, shaft wall) is built in front of the lime-sand heavyweight wall to hide plumbing and heating pipes and electrical wirings.

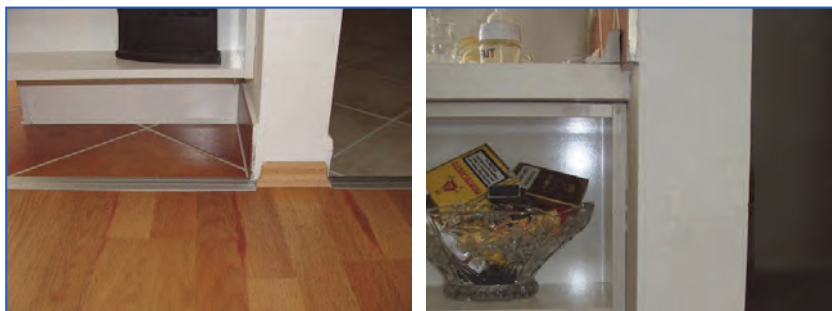


This is sometimes constructed from gypsum boards on metal studs which provide a cavity for the pipes and no decrease in acoustical performance. Unfortunately in some cases a 50 mm thick wall made of aerated concrete blocks (YTONG, density appr. 400 kg/m<sup>3</sup>) is built, that is glued directly to the heavyweight wall, and the plumbing and other accessories are placed in cavities carved (routed) into this wall. This results in decreased airborne sound insulation and in a perfectly working loudspeaker: the noise of flushing and water can reach  $L_A = 40$  dB inside the room.

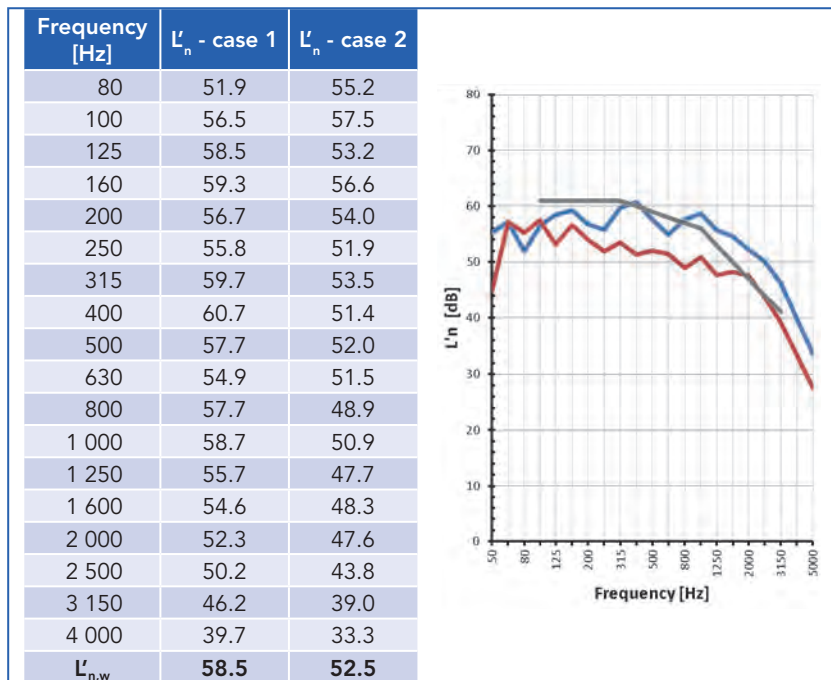
### Acoustic bridge by furniture

Nowadays the floating floor is built correctly, without any acoustic bridges, the floor tiling is separated from the wall, the gap is filled with elastic grout at the perimeter, and the skirting board is also installed correctly onto the wall, without connecting it to the floor. But an acoustic bridge can be easily created with the furniture: it stands on the ceramic tiles, but its side and the counter are pushed against the separating wall, that was built directly onto the concrete floor. This can be seen in Figure 11.4.

The impact sound insulation was measured between the flat with the improperly installed furniture and the flat below in many source-receiver positions. Figure 11.5 shows results of two measurements carried out on identical flooring constructions in different rooms: the kitchen with the acoustic bridge (first case) and the corridor without any acoustic bridge (second case). Even though the sound insulation requirement is only exceeded by 3.5 dB in the first case, the difference between the two cases is 6 dB.



**Figure 11.4.** Furniture standing on the properly constructed floating floor (with elastic grout at perimeter) and leaning against the separation wall that is built directly onto the concrete floor, creating an acoustic bridge.



**Figure 11.5.** Impact sound insulation measured in the kitchen with acoustic bridge (case 1, blue), and in the corridor without any acoustic bridge (case 2, red).

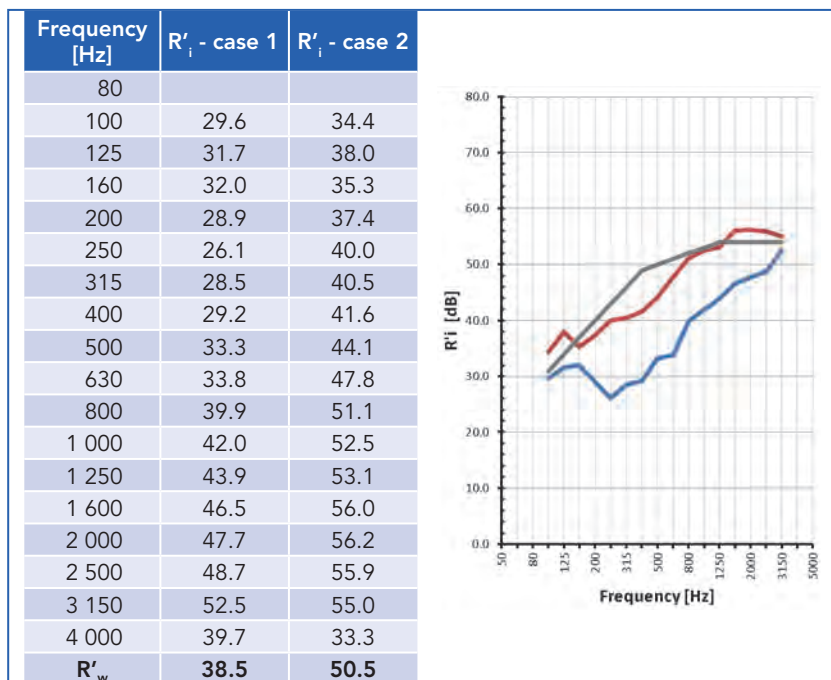
### Error in design of separator walls

Aerated concrete blocks are frequently used in the construction industry due to its low weight (YTONG, 390–540 kg/m<sup>3</sup>). But these blocks are not suitable on their own for walls separating dwellings. However due to lack of knowledge and/or neglecting acoustical requirements, separating walls have been built from these blocks – this was a typical error in designs at the beginning of the last decade (year 2000–2005).

Below an example is shown, where a wall was constructed with these blocks: two leafs of 100 mm wide blocks separated by 100 mm cavity were built directly onto the concrete floor. Furthermore in some points, polystyrene foam blocks were placed inside the cavity as spacers, creating a connection between the two leafs. In order to increase the poor acoustical performance of the wall, the cavity has been completely filled up with concrete (by injection). The airborne sound insulation measurement results for the original



case with empty cavity (case 1) and with the concrete-filled case (case 2) are displayed in Figure 11.6. Unfortunately, probably due to flanking transmission (rigid joints) and to the low density of the injected concrete, the resulting airborne sound insulation was still below the requirement. This case dates to 2006, when spectrum adaptation terms ( $C$ ,  $C_p$ ) were not yet introduced, the airborne sound insulation requirement was simply  $R'_w > 52$  dB.



**Figure 11.6.** Airborne sound insulation measured in the original case (case 1, blue) and with the cavities filled with concrete (case 2, red).

## Workmanship and design error

The bottleneck of constructing double walls (and furrings) is the cavity filling. A typical workmanship error is to completely stuff the cavity with glass or mineral wool (put as much as possible), instead of simply placing the sheets in there. Sometimes the construction manager even takes photographs to prove how properly the cavity was filled (stuffed), see the picture below. Of course such a document is a great help when investigating the reason for poor sound insulation performance.



**Figure 11.7.** Stuffing the cavity with glass wool – a typical workmanship error of constructing double walls and furrings.

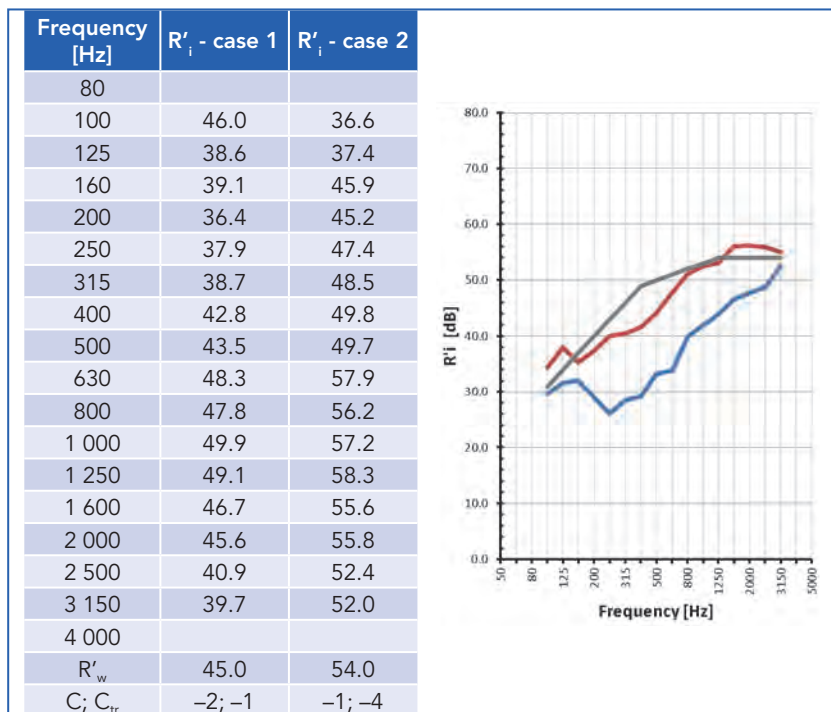
In the case shown above, the separating wall was made of the same aerated concrete blocks as in the previous example. The error in the design is obvious from the technical document that says '*separating walls are made of one layer of 100 mm thick YTONG (aerated concrete) blocks*' – the same construction as used within the dwelling for the inner separator walls (that have much lower acoustical requirement). Despite the technical document, the realised wall was a double leaf construction of these aerated concrete blocks, with cavity between – reason for this change is unknown. The picture shows an attempt to increase the sound insulation with opening up the wall and placing glass wool in the cavity.

### **Error in application of gypsum board furring**

Gypsum boards are very often attached directly to the brick wall instead of using plaster or parge coat, which radically decreases airborne sound insulation. The example below shows a case where walls with 300 mm thick clay block core were used to separate dwellings (Porotherm PTH 30 blocks). One layer of gypsum board was glued with plaster patches (dabs) to both sides of the brick core. To improve airborne sound insulation, the gypsum board was removed on one side of the wall, and was replaced by proper independent furring of gypsum board cladding placed on 50 mm metal stud frames, cavities filled with mineral wool. On the other side of



the wall, the original, directly attached gypsum board was not removed. Airborne sound insulation measurements were carried out in the original case (case 1) and with the new furring (case 2). The results are given in Figure 11.8.



**Figure 11.8.** Airborne sound insulation measured in the original case with gypsum boards attached directly to the brick wall (case 1, blue) and with the properly installed gypsum board furring (case 2, red).

### 11.1.2.3. Typical lightweight constructions

#### Floors

As mentioned above, timber buildings are not very common in Hungary. However the following timber floor construction was used in some cases with satisfactory sound insulation performance (ie. no complaints) – unfortunately no measurement result is available yet. The lower layer is a regular timber beam floor on which a mineral wool impact sound insulation



layer is placed, covered with a vapour barrier sheet. The next layer is made of timber beams with 200 mm height, the cavities of which are filled with expanded clay filling (Liapor 4/8 mm diameter grain loose dry filling). The upper lever of the floor is chipboard laid on laths, and the top layer is carpet. According to the data provided by the manufacturer [4] the airborne sound insulation of the above construction is  $R'_w \approx 52\text{--}56$  dB, and the impact sound insulation is  $L'_{n,w} \approx 57\text{--}53$  dB.

## 11.2. References

- [1] <http://www.ksh.hu/>
- [2] [http://www.napi.hu/magyar\\_gazdasag/a\\_paneleknel\\_is\\_van\\_rosszabb\\_tobb\\_szazezer\\_lakas\\_bontaserett\\_magyarorszagon.569326.html](http://www.napi.hu/magyar_gazdasag/a_paneleknel_is_van_rosszabb_tobb_szazezer_lakas_bontaserett_magyarorszagon.569326.html)
- [3] <http://www.emi.hu/>
- [4] <http://www.liapor.hu/?s=a3ab15bs53s>, <http://www.liapor.com>



# Building acoustics throughout Europe

## Volume 2: Housing and construction types country by country

# 12

## Iceland

Author:  
**Steindór Guðmundsson**

Verkís Consulting Engineers, Reykjavik, Iceland  
e-mail: [stgu@verkis.is](mailto:stgu@verkis.is)



## CHAPTER

## 12

## Iceland

## 12.1. Design and acoustic performance: Iceland

### 12.1.1. Overview of housing stock

The population of Iceland is approximately 325.000 inhabitants (2013). About 64% live in the Capital Region, and about 37% live in the capital Reykjavik. The following population overview is from [1].

**Table 12.1.** Most populated communities in Iceland (2012).

Community	Population
Capital Region total	203 594
Reykjavik	118 814
Kópavogur	31 205
Hafnarfjörður	26 486
Garðabær	11 283
Outside Capital Region total	115 981
Akureyri	17 875
Reykjanesbær	14 137
Total population	319 575

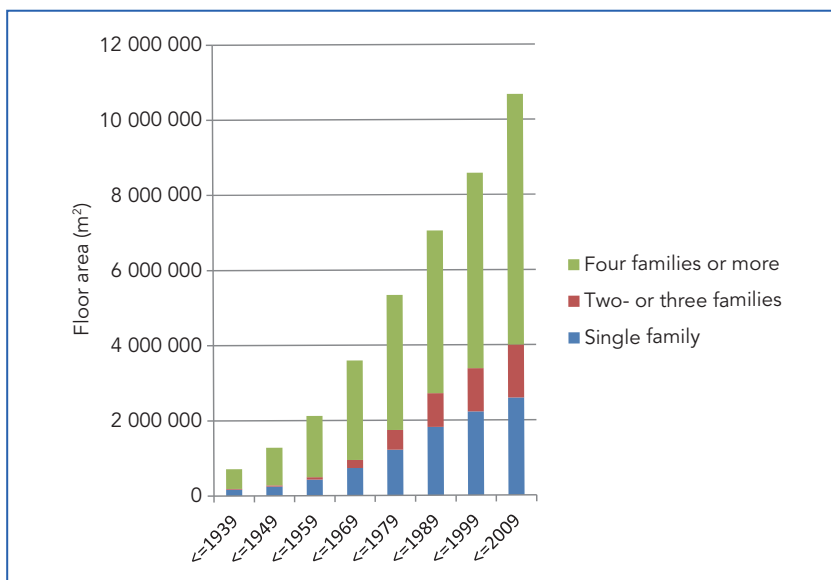
In the time period 1995-2007 about 80% of the dwellings in Iceland were privately owned but after 2008 the ratio has fallen to about 73 % [3].

Table 12.2 below shows the total number of dwellings by building type [3].

Figure 12.1 below shows the accumulated total size of dwellings in Reykjavik (in m<sup>2</sup>) from 1939 until 2009. The development for the total size of dwellings (in m<sup>2</sup>) would be similar for the country as a whole, but the category of dwellings with four families or more is relatively smaller outside the capital region. The figure is based on data from Registers Iceland (answer to an enquiry).

**Table 12.2.** Dwellings by building type (2010-2012).

Building type	Number of dwellings	%
Single-family houses, detached	35 100	27.0
Single-family houses, terraced	17 800	13.7
Residential buildings with 2 - 5 flats	24 800	19.1
Residential buildings with $\geq 5$ flats	46 900	36.1
Single room	3 200	2.5
Unknown	2 200	1.7
Total	130 000	100.0



**Figure 12.1.** The development of housing in Reykjavik 1939-2009.

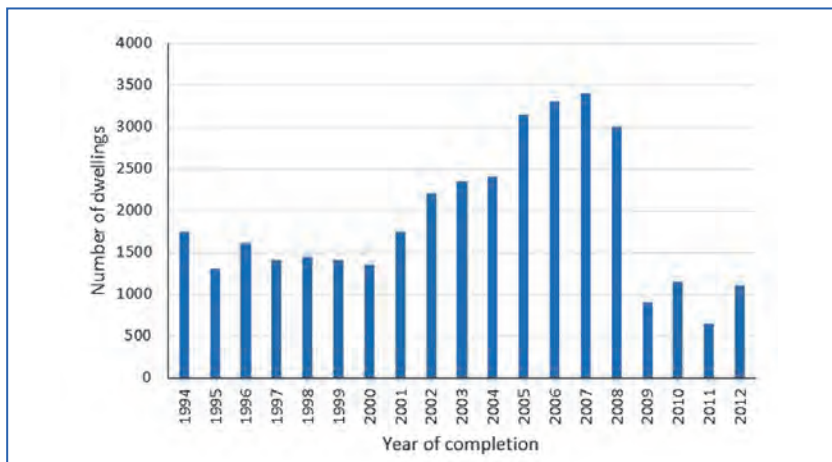
As can be seen in Figure 12.1 the total size of dwellings has been increasing almost linearly since 1959.

The total number of dwellings built per year on a national level in the years 1994-2000 was about 1500. In the period 2001-2005 there was approximately a linear increase up to about 3300, which was the average number of new



dwelling in the period 2005-2008. After 2008 the average number of new dwellings per year is only about 900 in the years 2009-2012 [2].

Figure 12.2 below shows the number of completed dwellings in Iceland 1994-2012 [2].



**Figure 12.2.** Completed new dwellings in Iceland 1994-2012.

### 12.1.2. New housing constructions

#### *Regulations and requirements*

The national requirements for sound insulation between dwellings were made stricter in 2012. Sound class C in [5] was made mandatory as minimum requirements. These demands were first introduced in 1998 as “recommended”, but the actual requirements were kept at the same levels as they had been from 1979.

The requirements from 2012, as given in the national standard IST 45, are [5]:

- Weighted apparent sound reduction index,  $R'_w \geq 55$  dB, between dwellings.
- Weighted normalised impact sound pressure level,  $L'_{n,w} \leq 53$  dB, from one dwelling to another.
- Weighted apparent sound reduction index,  $R'_w \geq 60$  dB and weighted normalised impact sound pressure level,  $L'_{n,w} \leq 48$  dB, from premises for commercial use or similar, to a dwelling.



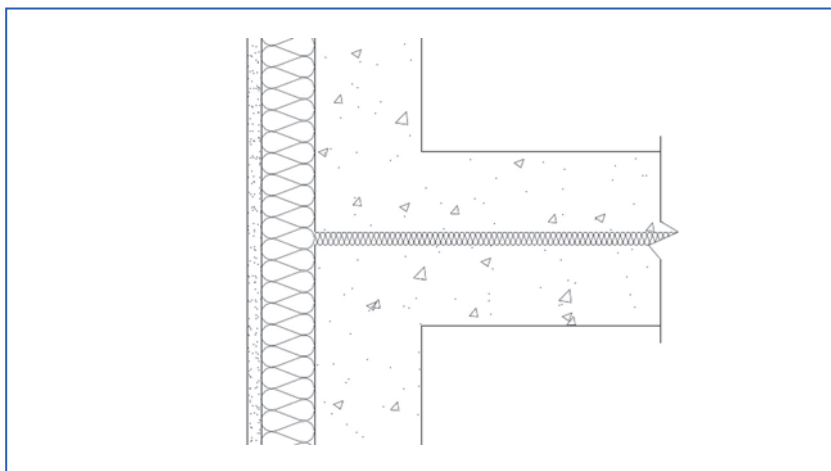
- Indoor sound pressure level from building service equipment,  $L_{p,AF,max} \leq 32$  dB and  $L_{p,Aeq,T} \leq 30$  dB.
- Indoor sound pressure level from outdoor noise sources such as traffic etc.,  $L_{p,AF,max} \leq 45$  dB (night) and  $L_{p,A,24h} \leq 30$  dB.
- Requirements for reverberation time in corridors and in stairwells is  $T \leq 1,3$  s.

There is in other words no specific requirement for facade insulation, as the required sound insulation will depend on the noise level outside the building.

In some separate rooms, such as kitchen, bathroom, toilet and similar rooms, 5 dB higher indoor sound pressure level from building service equipment is accepted.

### *Terraced housing*

Row houses/attached houses are most commonly built with heavyweight constructions, both the façades and the separating walls between dwellings, which are typically double walls with 25 mm mineral wool between them. With dwellings on two floors above each other, the separating floor is typically a heavyweight concrete construction. The thermal insulation is either on the inside of the façade wall as a plastered cellular plastic or it is on the outside of the façade.



**Figure 12.3.** Detail showing a typical junction between new terraced houses.

Description of a typical separating wall:

- 2 x 150 mm concrete walls with a 25 mm mineral wool interlayer.

Description of typical separating floor:

- Heavyweight floor 200 mm (parquet or tiles with/without resilient layer).

The base plate is usually 120 mm in situ cast concrete on insulation layer directly on the ground.

Typical errors in workmanship are:

- The double walls are not properly separated, especially at the façade, and this gives airborne flanking transmission via the façade when the thermal insulation is plastered cellular plastic on the inside of the façade.
- Instead of a mineral wool interlayer, sometimes a 12 mm soft particle board is used, which can give rise to impact flanking transmission via the thin concrete base plate, with hard floor coverings.

The constructions described in this chapter will in most cases fulfil the minimum requirements of class C in [5] and in most cases also the requirements for class B.

### *Apartments/flats*

Multi-dwelling houses are typically built with heavy floors and walls:

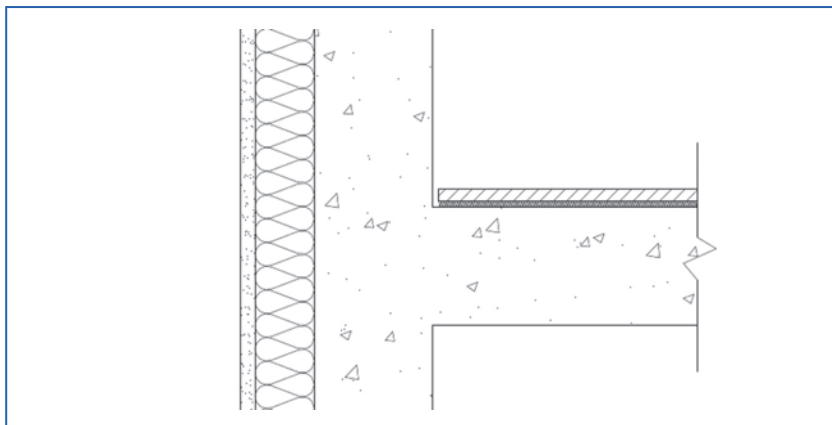
- 240 mm in situ cast concrete slabs (approximately 550 kg/m<sup>2</sup>)
- Impact sound insulation is typically taken care of by parquet or tiles on resilient layer.
- Walls separating dwellings are heavy concrete walls, typically 200 mm concrete, cast in situ.
- Façade walls are heavy concrete walls, typically 200 mm concrete, cast in situ. Thermal insulation is traditionally on the inside, but new apartment houses usually have the thermal insulation on the outside.

Typical errors in workmanship are:

- The hard floor covering (tiles/parquet) on the resilient layer has a direct contact with the walls or the free-standing kitchen furnishings (fastened directly to the concrete slab). This leads to flanking transmission of the impact sound.



- The resilient layer under the hard floor covering (tiles/parquet) is not soft enough, and this leads to flanking transmission of the impact sound. This is especially common under tiles, as the movement of tiles on a soft under-layer may crack up the cement joint between tiles.
- When the thermal insulation is plastered cellular plastic on the inside of the façade, it leads to airborne flanking transmission via the façade



**Figure 12.4.** Detail showing a typical separating floor between dwellings. Class C in [5].

Multi-dwelling houses made to fulfil sound class B in [5] are also typically built with heavy floors and walls and they also have heavy floating floors:

- 200 mm in situ cast concrete slabs.
- 50 mm resilient layer.
- 80 mm floating floor (concrete or anhydrite).
- Walls separating dwellings are heavy concrete walls, typically 220 mm concrete, cast in situ.
- Façade walls are heavy concrete walls, typically 200 mm concrete, cast in situ. The thermal insulation is usually on the outside.

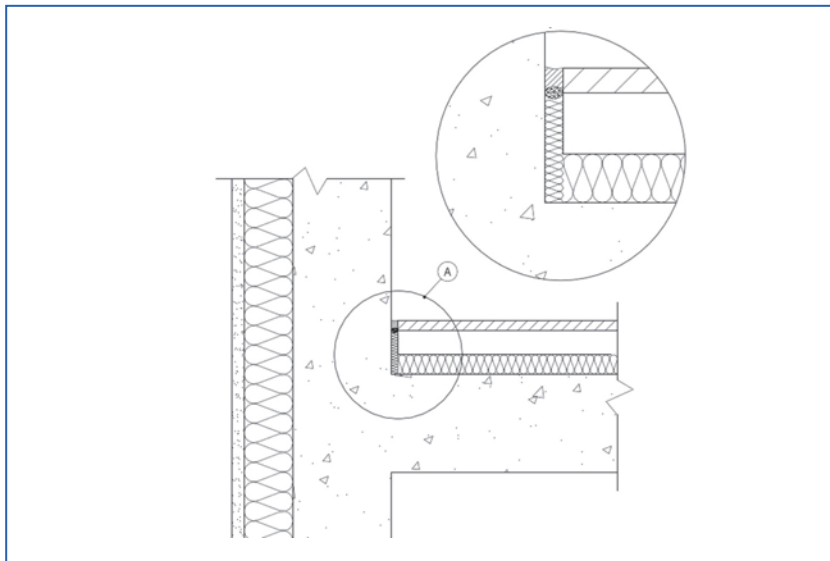
Typical errors in workmanship are:

- The hard floor covering (tiles/parquet) on the floating floor has a direct contact with the walls or the free-standing kitchen furnishings (fastened directly to the primary concrete slab). This leads to impact sound flanking transmission.





- The resilient layer under the floating floor is not soft enough, and/or the floating floor slab is not heavy enough. This leads to a relatively high resonance frequency (80-100 Hz) and  $L'_{n,w} + C_{i,50-2500} > 48$  dB, even though  $L'_{n,w} \leq 48$  dB.



**Figure 12.5.** Detail showing a typical separating floor between dwellings. Class B in [5].



**Figure 12.6.** Apartment house built in 2005.



### 12.1.3. Existing housing



**Figure 12.7.** Residential houses in Reykjavik from about 1925-1930.

#### Regulations and requirements

The first national requirements for sound insulation between dwellings were introduced in 1966-1967. The requirements were modified in 1979, and they were in use until 2012, but “recommended” demands were introduced in 1998. These recommended values for dwellings were the same as the then existing demands for row houses/linked houses. The demands from 1979 (for multi-dwelling houses) were:

- Weighted apparent sound reduction index,  $I_a \geq 52$  dB, between dwellings.
- Weighted normalised impact sound pressure level,  $I_i \leq 63$  dB (corresponding approximately to  $L'_{n,w} \leq 58$  dB), from one dwelling to another.

#### Terraced housing

Row houses/attached houses were most commonly built with heavyweight constructions, both the facades and the separating walls between dwellings. After 1979 the separating walls were typically double walls with 12 mm soft fibre board between them. With dwellings on two floors above each other, the separating floor was typically a heavyweight concrete construction. The thermal insulation was traditionally on the inside of the façade wall as a plastered cellular plastic.

Description of a typical separating wall:

- 2 x 125 mm concrete walls with a 12 mm soft fibre board interlayer.



Description of typical separating floor:

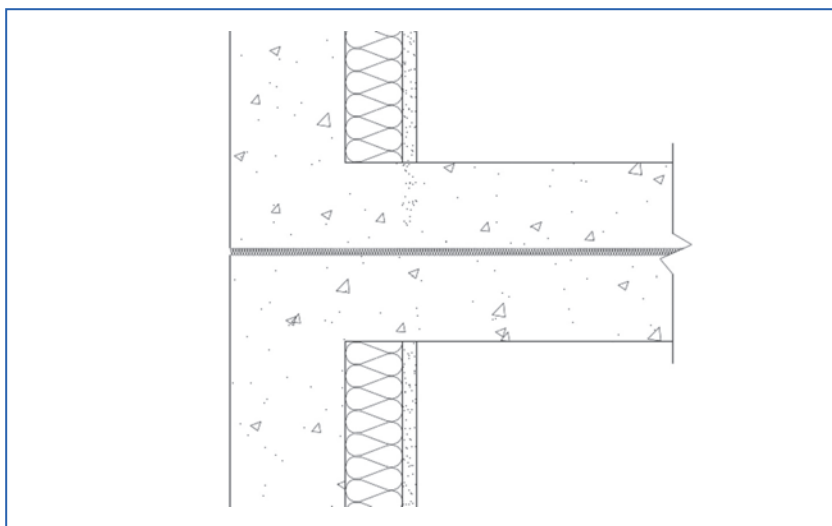
- Heavyweight floor 180 mm (parquet or tiles with/without resilient layer).

The base plate was usually 120 mm in situ cast concrete on insulation layer directly on the ground.

Typical errors in workmanship are:

- The particle board between the double walls has high shear stiffness and it is sometimes impregnated by the newly cast concrete, making it even more stiff. The façade walls are therefore not properly separated, and this gives airborne flanking transmission via the façade when the thermal insulation is plastered cellular plastic on the inside of the façade.
- Also the lack of proper separation in the double concrete walls can give rise to impact flanking transmission via the thin concrete base plate, with hard floor coverings.

The constructions described in this chapter will in many cases not fulfil the minimum requirements – which from 1979 have been almost the same as the present demands for class C in [5].



**Figure 12.8.** Detail showing a typical junction between terraced houses 1979-1998.

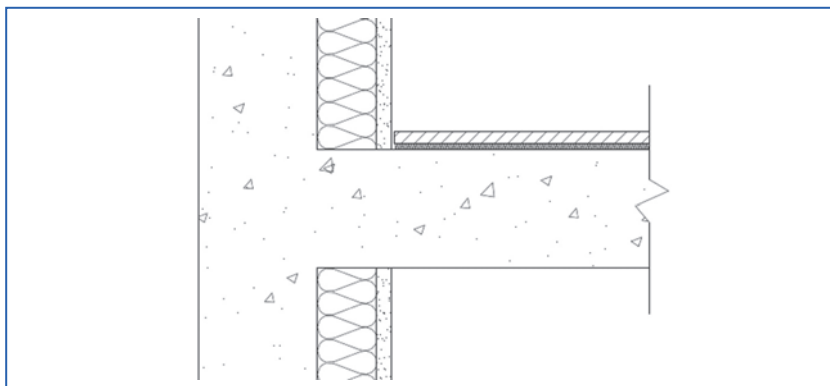


**Figure 12.9.** Row houses in Reykjavik from about 1980.

### Apartments/flats

Multi-dwelling houses were typically built with heavy floors and walls:

- 180 mm in situ cast concrete slabs (approximately 400 kg/m<sup>2</sup>).
- Impact sound insulation was typically taken care of by parquet or tiles on resilient layer.
- Walls separating dwellings were heavy concrete walls, typically 160 mm concrete, cast in situ.
- Façade walls were heavy concrete walls, typically 180 mm concrete, cast in situ. Thermal insulation was traditionally on the inside. From about 1960 the insulation was usually plastered cellular plastic.



**Figure 12.10.** Detail showing a typical separating floor between dwellings with thermal insulation traditionally on the inside.



Typical errors in workmanship are:

- The traditional method of thermal insulation on the inside gives airborne flanking transmission via the façade.
- The relatively thin concrete slabs between dwellings often give too high impact transmission with hard floor coverings, as the resilient layer selected is not soft enough.

The constructions described in this chapter will in many cases fulfil the minimum requirements from 1979. However in many cases the airborne flanking transmission is so large that the minimum requirement is not fulfilled. This is typically the case vertically between corner rooms with two large façade walls in each room.

Also many complaints come from people living below a concrete slab with a hard floor covering on a resilient layer which is not soft enough.



*Figure 12.11. Residential houses in Reykjavik from 1990.*

## 12.2. References

- [1] Statistical Yearbook of Iceland 2012: [http://issuu.com/hagstofa/docs/landshagir2012\\_lowres?e=7193385/5082887](http://issuu.com/hagstofa/docs/landshagir2012_lowres?e=7193385/5082887)
- [2] Statistical Yearbook of Iceland 2013: <http://issuu.com/hagstofa/docs/landshagir2013?e=7193385/5220768>
- [3] Statistics Iceland: Statistical Series – Prices and consumption 2013:1 <https://hagstofa.is/lisalib/getfile.aspx?ItemID=16009>
- [4] Registers Iceland, statistics <http://www.skra.is/markadurinn/talnaefni/>
- [5] Icelandic standard IST 45:2011 “Acoustic conditions in buildings. Sound classification of various types of buildings.” (In Icelandic.).



# Building acoustics throughout Europe

## Volume 2: Housing and construction types country by country

# 13

## Italy

Authors:

**P. Fausti<sup>1</sup>**

**S. Secchi<sup>2</sup>**

**A. Di Bella<sup>3</sup>**

**F. Scamoni<sup>4</sup>**

<sup>1</sup> Engineering Department, University of Ferrara

<sup>2</sup> Department of Industrial Engineering, University of Florence

<sup>3</sup> Department of Industrial Engineering, University of Padua

<sup>4</sup> Construction Technologies Institute of the National Research Council of Italy, Milan



## CHAPTER

## 13

## Italy

## 13.1. Legislation and standards in building acoustics

### 13.1.1. The enforced legislation DPCM 5-12-97

In Italy, the acoustics enforced legislation (DPCM 5-12-97) [1] prescribes the following minimum requirements for residential buildings:

- façade sound insulation  $D_{2m,nT,W} \geq 40$  dB ;
- airborne sound reduction index between dwellings  $R'_w \geq 50$  dB ;
- impact sound insulation  $L'_{n,w} \leq 63$  dB ;
- equivalent spl from continuous service equipments  $L_{A,eq} \leq 35$  dB(A);
- maximum spl, time constant "slow", for discontinuous operation  $L_{A,S,max} \leq 35$  dB(A).

In table 13.1, the complete set of limiting values for the different types of building is reported.

**Table 13.1.** Legal requirements concerning sound insulation and equipment noise.

Activities or building use	Parameter				
	$D_{2m,nT,w}$ [dB]	$R'_w$ [dB]	$L'_{n,w}$ [dB]	$L_{ASmax}$ [dB(A)]	$L_{Aeq}$ [dB(A)]
Hospitals, clinics and nursing homes	$\geq 45$	$\geq 55$	$\leq 58$	$\leq 35$	$\leq 25$
Dwellings, hotels and inns	$\geq 40$	$\geq 50$	$\leq 63$	$\leq 35$	$\leq 35$
Schools	$\geq 48$	$\geq 50$	$\leq 58$	$\leq 35$	$\leq 25$
Offices, commercial and recreational activities	$\geq 42$	$\geq 50$	$\leq 55$	$\leq 35$	$\leq 35$

For schools, limiting values for reverberation time also apply. The legislation applies only to new buildings and in restoration work (only for the elements affected).

For the single numbers only the calculations with third octave bands from 100 Hz to 3150 Hz are considered; the spectrum adaptation terms are not considered.

The frequent failure to comply with the minimum sound insulation performance of buildings built since 1998 has generated a great number of civil disputes between buyers and constructors. The main explanation can be found in the strong increase of acoustic performance requirements for buildings imposed by the Italian law of 1997. Furthermore, bad practice and workmanship errors frequently lead to very different results from those expected in the design phase.

Consequently, in order to improve the procedures to fulfil the requirements, many local regulations require to provide the estimation of acoustic performance in buildings at the design stage, and, in some cases, the results of measurements made after the construction.

It is expected that in future a technical standard should be inserted in a new law that explicitly provides for the classification of the acoustic requirements of new or completely refurbished buildings. This could provide an interpretation key which is easier and more immediately understandable to the buyers, to develop a system that encourages continuous improvement of building production, and reduce disputes between buyers and manufacturers.

### 13.1.2. *The Italian Standard UNI 11367 on Acoustic Classification of Dwellings*

The Italian Standard UNI 11367 [2, 3, 4] describes the procedures to define the acoustic classification of the property units of a building, whatever its use (dwellings, offices, hotels, commercial activities, etc.).

Sound classification could be expressed for each requirement or as a single descriptor. The requirements considered are listed below:

- façade sound insulation  $D_{2m,nT,w}$ ;
- airborne sound reduction index of internal partitions  $R'_w$ ;
- impact sound insulation  $L'_{n,w}$ ;
- sound pressure level from service equipments divided into those with continuous and discontinuous operation ( $L_{ic}$  and  $L_{id}$ ).



The determination of the sound classes is based on the average values of the performance of all field measurements carried out on the various building elements (with reference to ISO 140 series standards).

Classification can be based on the measurements of all measurable elements or of a number of elements through a sampling procedure; in the latter case the sampling uncertainty needs to be applied.

For schools and hospitals, classification scheme cannot be used; in the standard, reference values for these two types of buildings are included.

The procedure for the sound classification of a dwelling involves the identification of all the verifiable technical elements and their field measurements. For each element, the "net value", which corresponds to the measured value corrected with the *measurements uncertainty*, is determined. For each requirement, the energetic mean value of the results obtained for every technical element (referred to a single dwelling) is calculated. This value defines the sound class of the related requirement, according to Table 13.2.

**Table 13.2.** Sound classes for each requirement.

Class	Parameter				
	$D_{2m,n,T,w}$ [dB]	$R'_w$ [dB]	$L'_{n,w}$ [dB]	$L_{ic}$ [dB(A)]	$L_{id}$ [dB(A)]
I	$\geq 43$	$\geq 56$	$\leq 53$	$\leq 25$	$\leq 30$
II	$\geq 40$	$\geq 53$	$\leq 58$	$\leq 28$	$\leq 33$
III	$\geq 37$	$\geq 50$	$\leq 63$	$\leq 32$	$\leq 37$
IV	$\geq 32$	$\geq 45$	$\leq 68$	$\leq 37$	$\leq 42$

The relevance of the standards is not only restricted to the performance descriptors and their levels, but also on the procedures to obtain the sound classification and the choice of the samples to be tested. During the preparation of the classification scheme, most of the work was devoted to the definition of the procedures for the sampling choice and for the introduction of a *sampling uncertainty* [2, 3, 4]. For serial building, with repeated elements (such as particular kind of residential buildings with serial plan of dwellings), there is the possibility to carry out measurements on a limited number of these elements (samples). The sampling procedure involves the identification of homogeneous groups for each requirement, in terms of element type and dimensions, test rooms dimensions and installation techniques. A homogeneous group is defined when the identity

is verified for several aspects which could influence the measurement results. For example, for façade sound insulation: window/door type and configuration, total façade surface, volume and dimensions of the receiving room, windows/doors surface and dimensions, etc. 20% tolerance is allowed. Sample selection is based on the analysis of final construction design and on the structures and technical specifications of service equipments. In case of residential buildings, homogeneous groups should be made with elements that belong to different dwellings. For every homogeneous group at least 10% of elements (with a minimum of 3 elements) are identified to carry out measurements. Then, the sampling uncertainty  $U_{shr}$ , which is related to the sampling standard deviation  $s_{sh}$  and the coverage factor  $k$ , must be calculated. The coverage factor  $k$  depends on the confidence level and on the number of measurements; the standard fixed 3 confidence levels (70, 75 and 80 %). For each dwelling, each technical element belonging to a homogeneous group must be associated to the related representative value and the energetic mean, for each requirement, must be calculated between different homogeneous groups. After the application of the statistical procedure for each dwelling, the sound class is determined both for each requirement and as mean value. The application of the sampling procedure for serial buildings, with a large number of similar residential units (such as large residential areas with repeated buildings), this could strongly reduce the number of measurements. For non-serial buildings, with a large number of residential units whose building elements are not similar, the sampling procedure does not limit enough the number of measurements. Most part of Italian residential buildings has a small number of homogeneous technical elements and thus a high number of homogenous groups, with consequently a high number of measurements. Moreover, in this case the statistical approach, used for the sampling uncertainty calculation, is not always reliable. For this reason, a new technical standard, which refers the procedure of the acoustic classification to non-serial buildings (UNI 11444-2012), was prepared and published [5].

This standard [5] provides guidelines for the selection of those residential units with non-serial characteristics which, on the basis of current knowledge, are supposed to be most critical in terms of acoustic performances with respect to the other units of the same building. For these units, measurements of acoustic parameters can be carried out in order to determine its classification, on the basis of the procedure described by the UNI 11367: 2010 [2]. The results of the measurements carried out on the technical elements of the critical units, selected

according to this specification, may constitute a useful information basis to estimate the acoustic class of the other units of the same building, although the class cannot be directly transferred. In particular, it can be assumed that, with no hidden defects, the class attributable to them would not be worse than that determined for the selected critical units.

Nowadays the technical standard UNI 11367 is still voluntary and has not been made mandatory by law. Its application, therefore, has so far been very limited. This is partly due to the need for significant amount of time and resources for the measurements, if compared with the evaluation of the simply fulfillment of administrative requirements.

## 13.2. Design and acoustic performance

### 13.2.1. Overview of housing stock

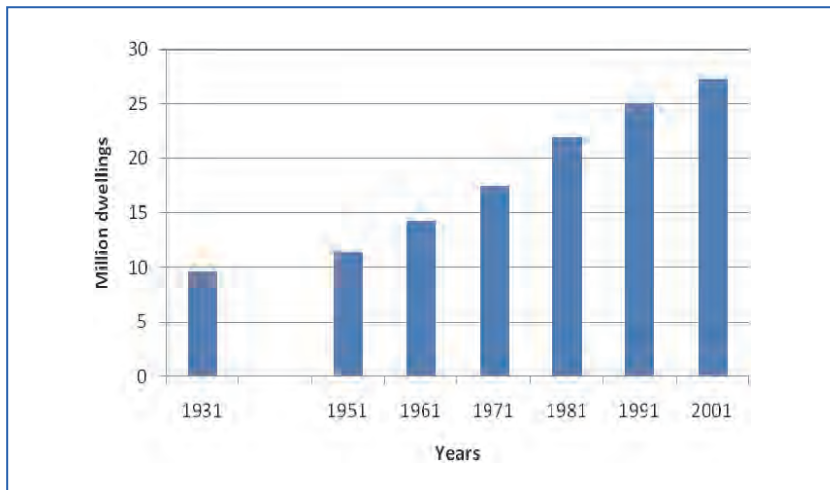
In this paragraph information on the population, building typology and quantity of housing stock is reported. Most of the data were taken from ISTAT [6] (the Italian National Institute of Statistics); useful information was found in the Italian report of the TABULA (Typology Approach for Building Stock Energy Assessment) European project [7]. Relevant for the understanding of the acoustic quality of residential buildings is the classification of the buildings considering the construction period and size. The construction period is relevant not only for the different technological solutions and the performance of the materials used, but also for the evolution of the enforced legislation. Regarding size, at a European level there are still no standard categories for classification. The most commonly used are: detached houses (single-family, not attached), semi-detached houses (multi-family homes), attached houses (terraced house, row house, linked house, town house), apartment block (block of flats, tower block), etc.

#### *The quantities of housing stock and total population*

Italy has approximately 60 million inhabitants [6]. At national level the following general information is reported [6, 7]:

- the whole Italian residential building stock consists of approximately 11.3 million of buildings;
- the total amount of dwellings in 2001 is 27.3 million (approximately 16 million flats, 5 million attached houses and 6 million single family houses);
- the average floor area of an Italian dwelling is 96 m<sup>2</sup>.

In the following figure the number of dwellings per year is reported.



**Figure 13.1.** Number of dwellings per year (up to 2001).

Other data show that the production of new housings in Italy was about 250,000 in 2007. A decrease in the realization of new dwellings of more than 20% was estimated for the period 2007-2012.

The following pictures show some examples of building typology divided per size and per construction period: figure 13.2 apartment block; figure 13.3 attached house.



**Figure 13.2.** Apartment block: a) 1950-60s; b) 1970-80s; c) 2000-10s.

### The most populated cities

The most populated cities in Italy are [8] Rome (2,64 million), Milan (1,24 million), Naples (0,96 million), Turin (0,87 million), Palermo (0,66 million) and Genoa (0,58 million).



**Figure 13.3.** Attached houses: a) 1950-60s; b) 1970-80s; c) 2000-10s.

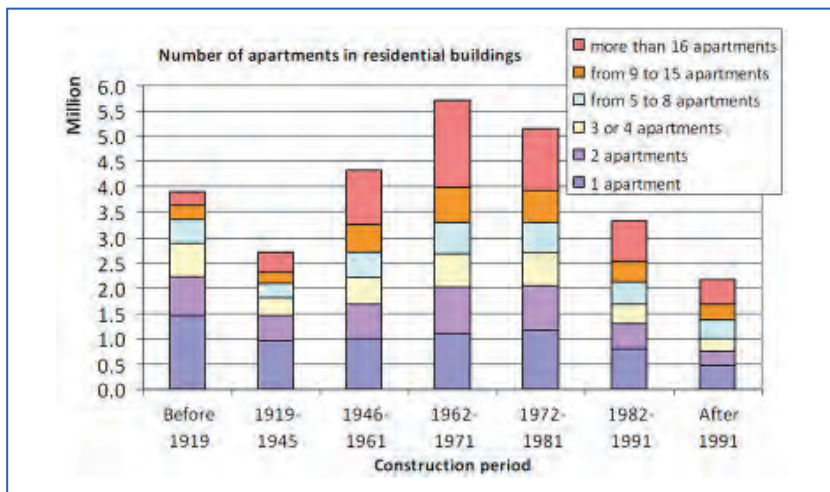
*Proportion of apartments, terraced (row) and detached houses [7]*

Figures 13.4 and 13.5 [7] show the number of apartments in Italian residential buildings by construction period as a function of number of apartments per building and of contiguity to other buildings.

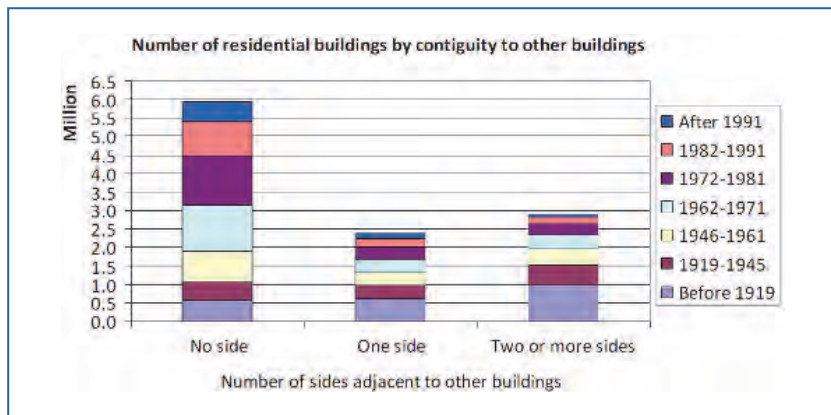
**13.2.2. New build housing constructions**

*Typical heavyweight constructions*

The most common building typologies are realized using heavyweight constructions, although also lightweight constructions have been more used in the last decade.



**Figure 13.4.** Number of apartments in residential Italian buildings by construction period and number of apartments in the building (up to 2004) [7].



**Figure 13.5.** Number of Italian residential buildings by construction period and contiguity to other buildings (up to 2004) [7].

For the partition walls (between dwellings), the following type of solutions are used:

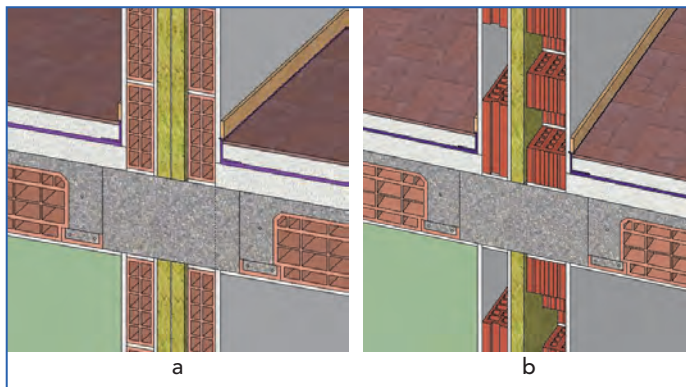
- double layer walls with insulating materials (69%);
- single layer walls (22%);
- single layer walls with linings (5%);
- other (4%).

For the partition floor, heavyweight floors with floating floors are generally used. The most common floors are those realised with bricks and concrete; prefabricated concrete panels or beams are also used.

Figures 13.6.a and 13.6.b show the most frequent combinations, for double walls, in Italian new buildings.

The first kind of Italian partition analyzed (figure 13.6.a) was quite largely used in buildings realized in Italy after 2000 and is still used in many cases. It consists of two layers of hollow bricks, each 80 mm thick, with an apparent density between 700 and 800 kg/m<sup>3</sup>, plastered with 10-15 mm of mortar on both sides and on one side of the cavity. In the cavity there are two layers of mineral wool, each 40 mm thick.

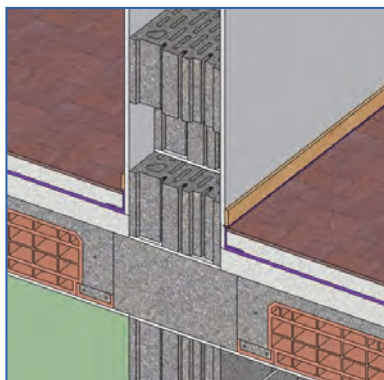
The second kind of Italian partition analyzed (figure 13.6.b) is more diffused in recent years because of its better performance in comparison with the previous solution.



**Figure 13.6.** a) Italian double wall type 1, b) Italian Double wall type 2.

It consists of a layer of hollow bricks 80 mm thick (with an apparent density between 800 and 900 kg/m<sup>3</sup>) and a layer of semi-full bricks 120 mm thick (with an apparent density between 800 and 1000 kg/m<sup>3</sup>), plastered with 10-15 mm of mortar on both sides and on one side of the cavity. In the cavity there are 40-50 mm of mineral wool and 20-30 mm of air.

Concerning monolithic walls, typical Italian partitions used between dwellings, they are realized with expanded clay and concrete blocks characterized by an apparent density between 1200 and 1400 kg/m<sup>3</sup>, plastered with 10-15 mm of mortar on both sides (figure 13.7). There are two thicknesses for this kind of partition: the first one is realized with

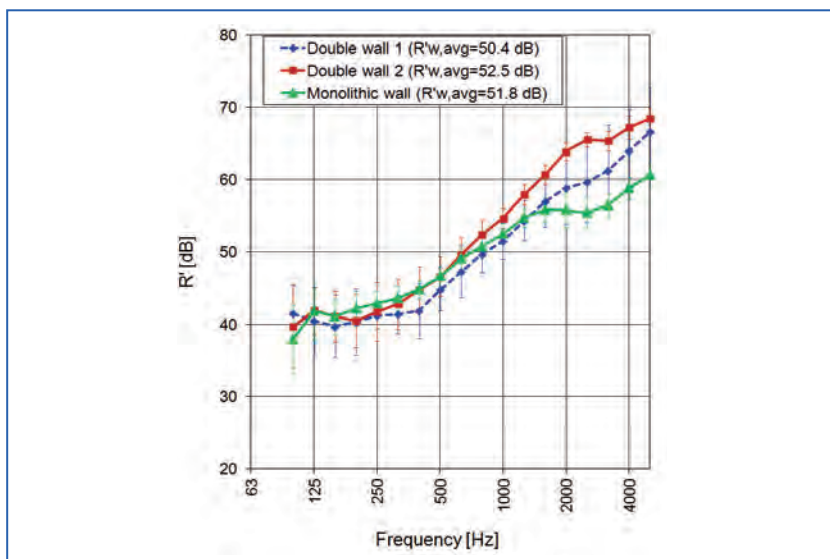


**Figure 13.7.** Typical Italian monolithic wall with expanded clay and concrete blocks.



blocks 250 mm thick, while the second with 300 mm thick blocks. Other types of monolithic walls are realized with clay blocks, frequently with big holes filled with concrete, or with additional components in order to improve the thermal insulation.

Figure 13.8 shows the comparison between averaged values of SRI for the three different type of partitions mentioned above (figures 13.6a, 13.6b and 13.7), tested in different real buildings. For the single walls (figure 13.7), data related to expanded clay and 250 mm thick concrete blocks are reported [9, 10].



**Figure 13.8.** Comparison between the average airborne sound insulation  $R'$  of the double walls and monolithic wall. The vertical bars represent the standard deviation among the measurements (10 measurements on double walls 1, 33 measurements for double wall 2, 43 measurements for monolithic walls).

### Typical errors in design [11]

In this section some examples of the most frequent design errors for airborne sound insulation, impact sound and façade sound insulation are listed.

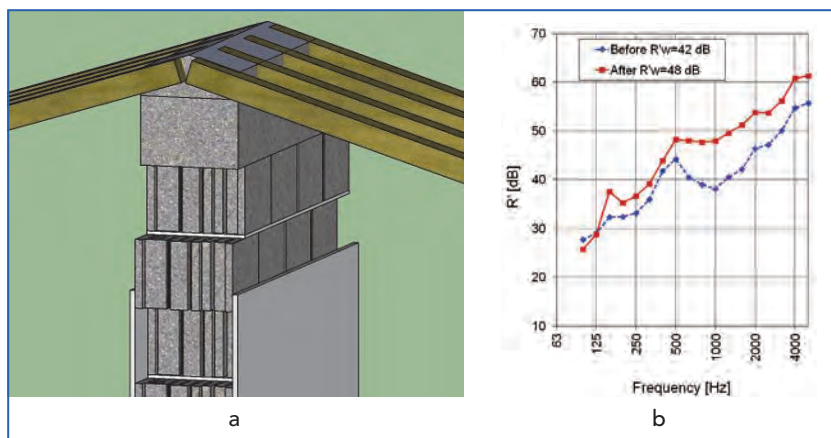
- Attic rooms: roof (ventilated or not) not interrupted in correspondence with the junction with the partition walls (figure 13.9).





- Lack of riddle or structural beam on the floor slabs above the separating walls.
- Service zones made symmetrically (not staggered) on both sides of the wall (electrical box, ventilation pipes, etc.).
- Lack of floating floor in terraced houses, adjacent horizontally (figure 13.10).
- Stairs rigidly connected to the partition wall.
- Lack of acoustic break on the windowsill (figure 13.14).
- Shutter systems with acoustic leakage (ex.: external rolling shutter with internal boxes) (figure 13.11).

In the following figures, examples of the above mentioned errors are illustrated, including experimental results.



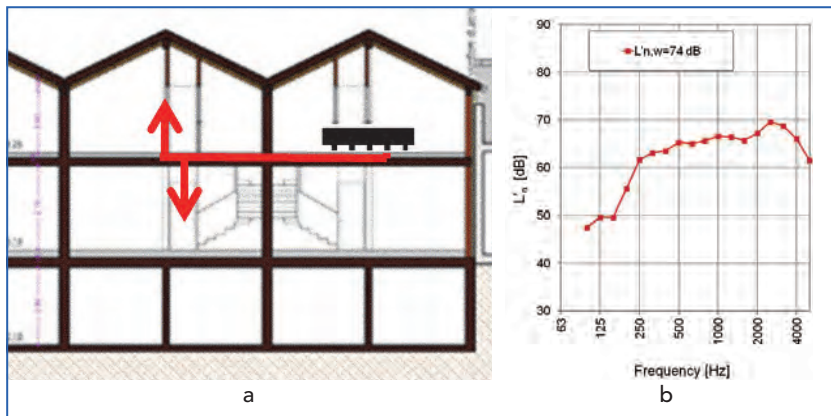
**Figure 13.9.** a) Example of a critical joint between the separating wall and the roof, b) Case study: airborne sound insulation of a wall before and after the filling of the cavities between the roof and the wall.

### Typical errors in workmanship [11]

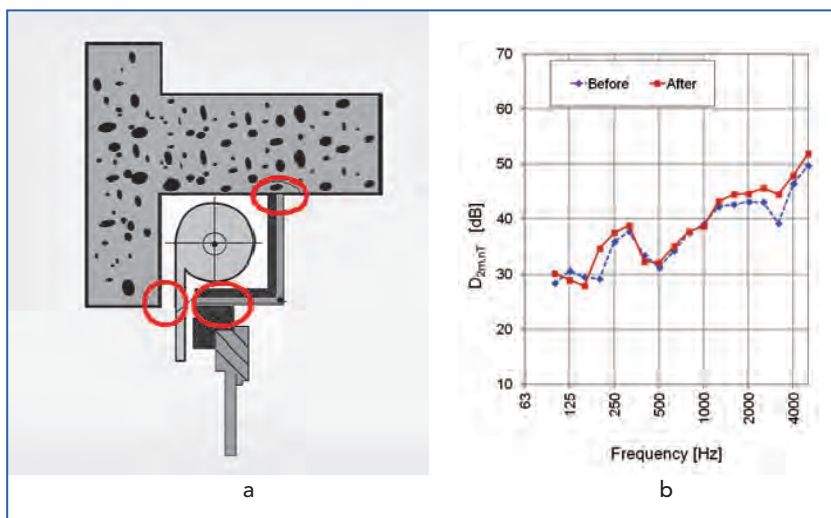
In this section some examples of most frequent workmanship errors for airborne sound insulation, impact sound and façade sound insulation are listed.

Airborne sound insulation:

- Lack of mortar in vertical joints between blockwork.



**Figure 13.10.** a) Example of the transmission path between two terraced houses without the floating floor, b) Case study: impact sound in horizontal direction between two terraced houses.



**Figure 13.11.** a) Leakages between shutter box, wall and window frame, b) Case study: façade insulation before and after sealing between shutter box and wall.

- Sound absorbing material not continuous in the cavity of cavity walls.
- Pipe chases for building services not properly filled with mortar.

- Lack of plaster on one side of the cavity in the cavity wall, when prescribed in the chosen technical solution.
- Tears in the sound-absorbing material inside the cavity of walls due to service zones or pipe chases: the subsequent filling with mortar may create a bridge between the two leaves of the cavity wall.
- Non suitable resilient layer, used as isolation mechanisms at “wall-floor” junctions, under single heavy walls (risk of crushing of resilient layer).
- Interlocking blocks (blocks that do not need mortar) not properly stuck to each other.

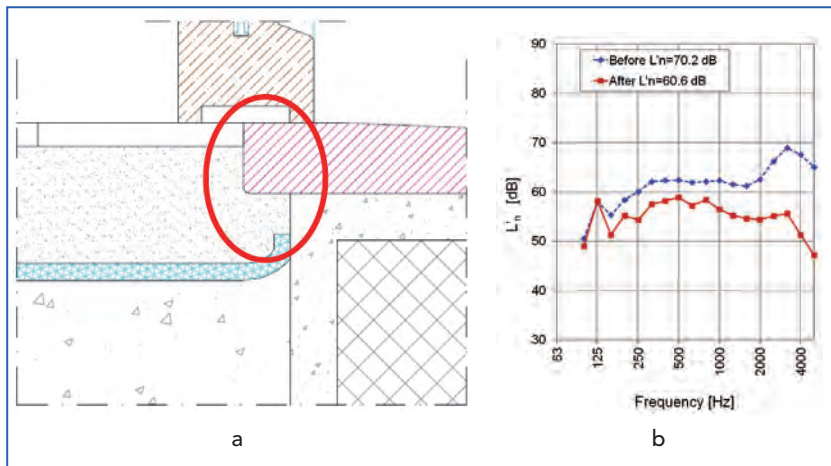
Impact sound:

- Perimeter resilient band not continuous, especially in corners.
- Perimeter resilient band not properly adherent to the walls and the consequent presence of mortar between the band and the walls.
- Rigid contact between the ceramic tiles or the floating mortar with the French window marble doorstep (figure 13.12).
- Perimeter resilient band too short or cut before the placing of the ceramic floors (figure 13.13).
- Lack of structural separation between the floating mortar in correspondence with the door of the rooms.
- Tears in the resilient material of the floating floor.
- Ceramic tiles against the walls.
- Floor surface below the resilient material not perfectly flat or not properly cleaned (presence of brick or iron pieces).
- Skirting board in direct contact with ceramic/parquet floor (figure 13.13).
- Presence of pipes not fully embedded into the lightened mortar (under the resilient material).

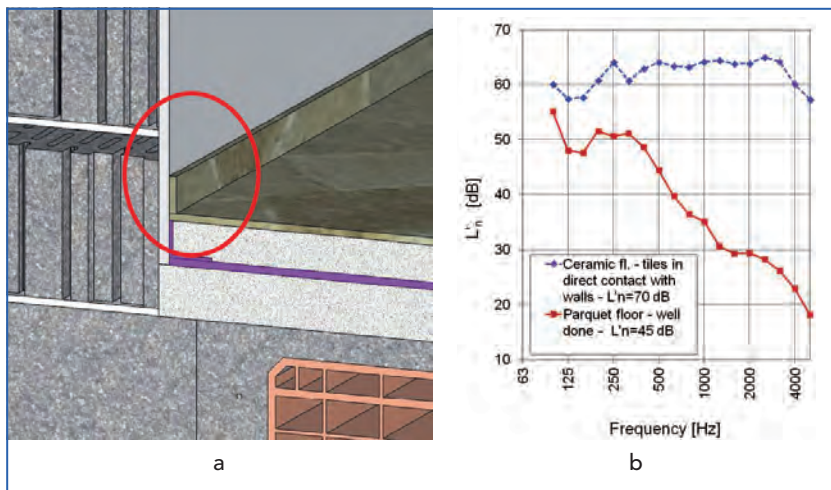
Façade sound insulation:

- Bad window adjustment (regulation, set-up etc.).
- Lack of leakage sealing between shutter box and wall and/or window frame.

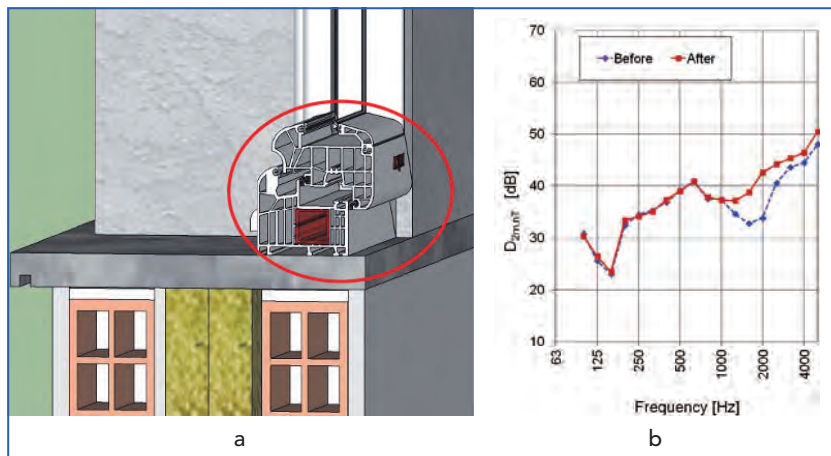
In the following figures, examples of the above mentioned errors are illustrated, including experimental results.



**Figure 13.12.** a) Example of the rigid contact between the ceramic tiles or the floating mortar with the French window marble doorstep, b) Case study: impact sound before and after the repair.



**Figure 13.13.** a) Example of tiles in direct contact with the walls and skirting board in direct contact with the floor, b) Impact sound with different paving: ceramic tiles with workmanship errors as in the picture, parquet floor well done.



**Figure 13.14.** a) Example of acoustic break on the windowsill, b) Façade insulation before and after the window adjustment.

### 13.2.3. Existing housing

#### *Typical constructions found in existing stock and their performances [4, 12]*

The technological characteristics of buildings realized in Italy between 1950 and 2000 have been analyzed by means of different sources.

Approximately 90% of buildings realized in Italy since the post-war period have separating and façade walls in brick elements and floors with clay and concrete blocks (see figure 13.15).

Gypsum plasterboard walls or gypsum block walls had their maximum spread in the 70s, while the precast concrete wall panels had their diffusion in the 70s and 80s as a consequence of the diffusion of prefabrication techniques; finally, walls of lightweight concrete blocks have become more important in recent years.

In the 50s and at the beginning of the 60s there was a growing need for low-cost housing in the large city suburbs, consequently these houses were built in a short time and there were many errors caused by workmanship. The mass per unit area ( $m'$ ) of the walls wasn't sufficient to limit sound transmission.

The airborne and impact sound insulation between dwellings was improved after the publication of the first Italian law for sound insulation of buildings (the decree of December 1997 [1]) (figure 13.16 and 13.17).

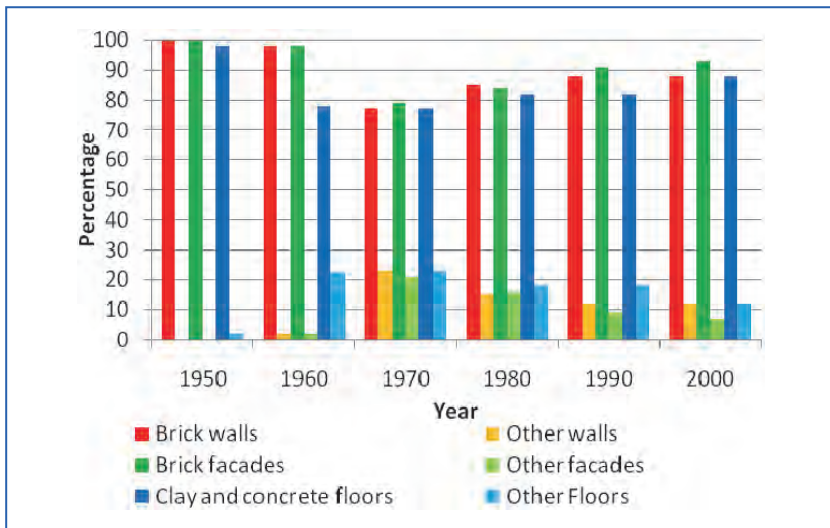


Figure 13.15. Evolution of Italian separating walls, façades and floors technologies since the post-war period.

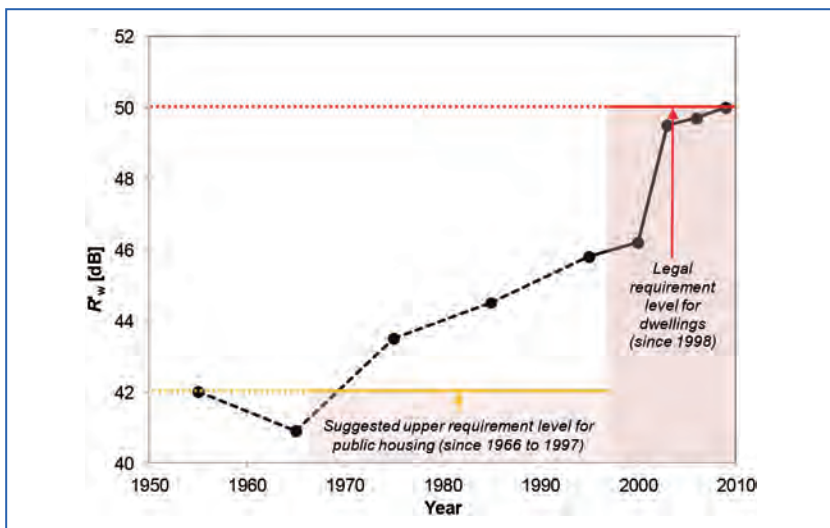
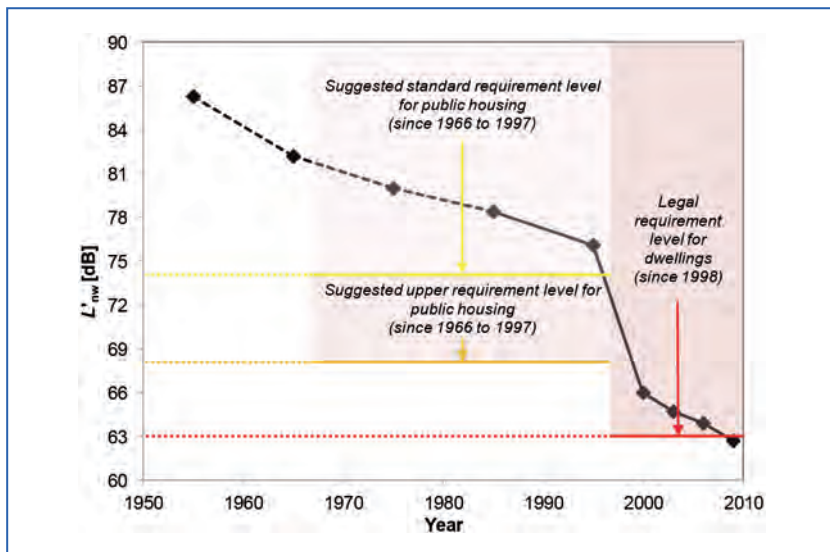


Figure 13.16. Evolution of Airborne Sound Insulation of Italian dwellings since 1950; the solid line is a weighted average of measured data; the dotted line represents estimated data; levels of mandatory and suggested requirements in recent years are highlighted [4].



**Figure 13.17.** Evolution of Impact Sound Insulation of Italian dwellings since 1950; the solid line is a weighted average of measured data; the dashed line represents estimated data; levels of mandatory and suggested requirements in recent years are highlighted [4].

The historical analysis of the acoustic performance of façades (figure 13.18) shows that the improvement of façade sound insulation follows the effect of the technological evolution of windows.

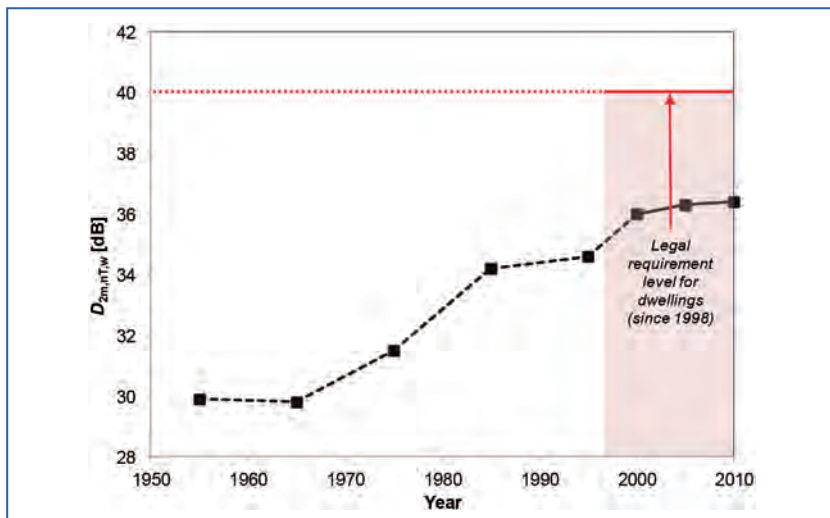
### *Period of building, description of the building and acoustic performances*

#### **Italian buildings built between 1950 and 1975**

In the period approximately between 1950 and 1975, building floors were mainly realized in clay and concrete, had a thickness of about 30 cm (24 cm prefabricated structure + 6 cm flooring), a surface mass of about 240 kg/m<sup>2</sup> and had no elastic layer (no floating floor). Their typical performance was about 47 dB for  $R'_w$  and 79 dB for  $L'_{nw}$  (values based on estimated data).

Partition walls between adjoining dwellings were about 20 cm thick and realized with a single layer of hollow bricks plastered on both sides, while inner walls were typically 10 cm thick in hollow bricks plastered on both sides.

The acoustic performance of partition walls between different dwellings may be assumed as  $R'_w = 43$  dB.



**Figure 13.18.** Evolution of Façade Sound Insulation of Italian dwellings since 1950; the solid line is a weighted average of measured data; the dashed line represents estimated data; level of mandatory requirement is highlighted [4].

Façades were mainly realized with 26 cm thick cavity walls and windows with 3-4 mm thick single glass and wood frame. The typical acoustic performance was about  $R_w = 23$  for windows and 52 dB for walls. In many cases there were wood roller blind boxes while the ventilation holes in kitchens weren't obligatory.

### Italian buildings built between 1975 and 1998

In this period building floors were mainly realised with clay and concrete and the total thickness was about 30 cm. In some cases there was a floating floor.

The typical acoustic performance was about  $R'_w = 48$  dB (value based on measured data) dB and  $L'_{nw} = 76$  dB.

Partitions between adjoining dwellings realized between 1975 and 1998 were mainly 28 cm thick double walls without insulating material in the cavity, with a surface mass of about 260 kg/m<sup>2</sup>; inner walls were made with hollow bricks plastered on both sides, 10 cm thick.

Acoustic performance of partitions between different dwellings was approximately  $R'_w = 47$  dB (according to different measured values).



Façades of buildings of this period were composed of cavity walls with insulating material, 28 - 30 cm thick and windows with double glass panel with wood or metal frame with thermal break. Typical acoustic performance ( $R_w$ ) was about 51 dB for walls and 31 dB for windows (values based on measured data).

### *Methods for improving sound insulation*

The improvement of acoustic performance of Italian existing buildings is generally based on the following points.

#### **Improvement of airborne sound insulation between dwellings**

- Realisation of wall linings with plasterboard and elastic layer.

#### **Improvement of impact sound insulation of floors**

- Realisation of floor lining with floating floors.

#### **Improvement of sound insulation of façades**

- Window replacement using window-shutter monoblock system and stratified glazing or leakage sealing between frame and wall and/or frame and glazing.
- Improvement of acoustic performance of the internal shutter box by filling with absorbing material, by sealing leakages and adding additional heavy linings.
- Improvement of acoustic performance of the kitchen ventilation system by using silencer.

### **13.3. Field evaluation of acoustic performance and social survey**

In the years 2009-2010, an application of Italian Classification Standard UNI-11367 regarding the acoustic classification of residential units [2, 3, 4] was made using acoustic tests carried out in several public housing buildings in the northeast of Italy. This project involved a whole neighbourhood of the city of Verona, affected by a global renewal. The purpose of the project was not only a thermal and acoustic improvement of existing buildings, but also a social renewal of the neighbourhood with the construction of new residential buildings and shops. In this stage of

the project 8 residential buildings (with a total of 72 flats) were renewed and 3 new buildings were built (40 flats and 4 shops).

Existing and refurbished buildings were of two types: with concrete structures and with brick structures. In existing buildings not affected by the renewal works, only windows were changed. For refurbished buildings, a refurbishing through a “dry” construction site was used, meaning that the least amount of concrete and mortar possible has to be used. In order to complete the work in a short period of time wide use was made of prefabricated products, e.g. gypsum plasterboards coupled with soundproofing material. Within the dwellings, a ceiling radiant heating system was also installed. The selected option allows the installation of the system without resorting to the demolition of floors and screeds. Instead, for the thermal insulation of the buildings the solution chosen provides the use of a wall cladding system on the external walls. All the internal and external doors and windows were replaced. For new buildings, brick structures with external thermal insulation and radiant floating floors were chosen. In figure 13.19 the average performance of building elements is shown.

In the years 2011-2012, the COST TU0901 questionnaire [13] was distributed in existing buildings (not affected by the renewal or before the renewal), in renewed buildings and new buildings, in these two last cases after at least a year of residence. All renewed and new buildings were completely acoustically tested before tenant occupation; some of the existing buildings were not tested but they are identical to renewed buildings, tested before the beginning of works.

Questionnaires were submitted personally door to door. This form of distribution was chosen in order to have a higher percentage of response from residents. For the data analysis it is important to take into account that most tenants are retired women over 65 years old or housewives.

Extensive data were obtained from the comparison between the results of field measurements with the answers to the questionnaires. The complete analysis can be found in [14]. An interesting observation that can be derived from this analysis concerns the acoustic performance of building elements that lead to 0% of people disturbed by noise as extrapolation of data trend line.

In figure 13.20 results are given as average values of performances for people with a disturbance rate higher or equal to a certain level (subjective score higher or equal to 3, 5 and 8, where higher scores correspond to higher disturbance).

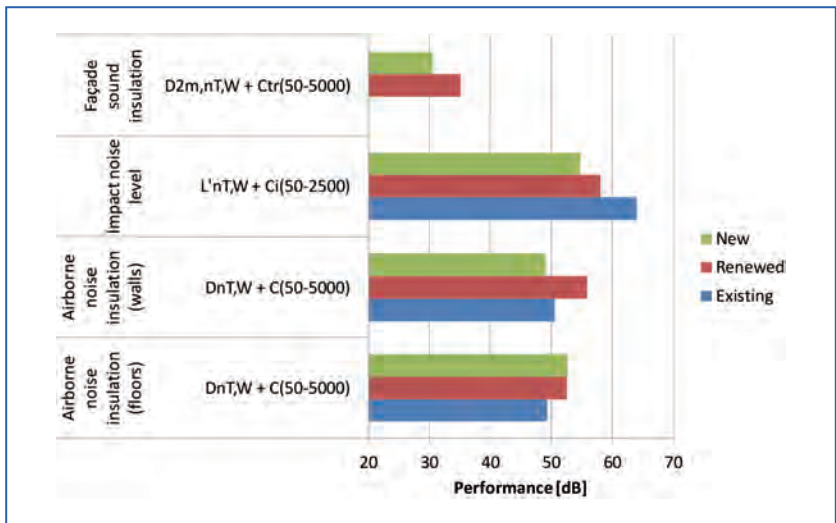


Figure 13.19. Average performance of building elements for the dwellings involved in the survey project (field evaluation and questionnaire).

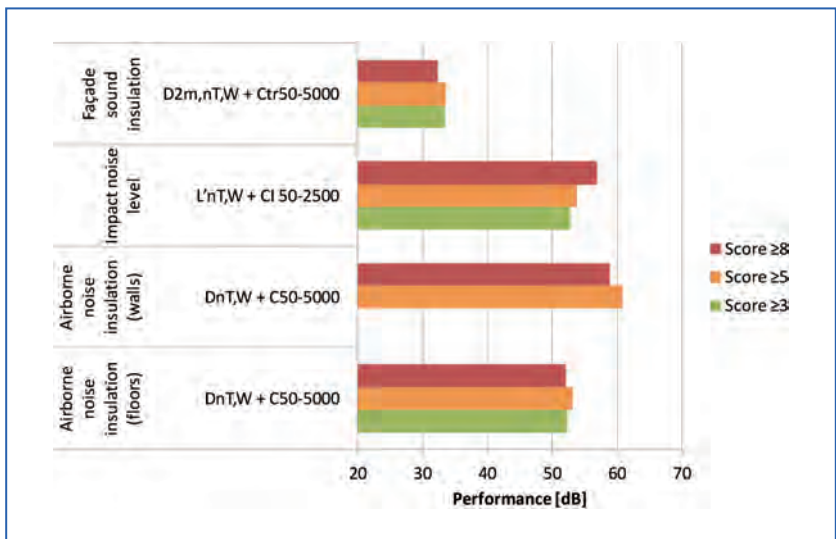


Figure 13.20. Values of building elements acoustic performances theoretically giving a percentage of disturbed people equal to zero for a subjective score higher or equal to 3, 5 and 8 (higher scores correspond to higher disturbance) in the dwellings under test.

## 13.4. Acknowledgements

We acknowledge gratefully Renzo Cremonini, Elisa Nannipieri, Chiara Martina Pontarollo, Andrea Santoni and Chiara Scrosati for their collaboration during the doctoral researches and during the activity of the COST Action TU0901.

A special thanks to the colleagues of the COST TU0901 for the helpful advices and suggestions.

## 13.5. References

- [1] Prime Ministerial Decree of December 5th 1997, Determination of passive acoustic requirements for buildings (in Italian).
- [2] UNI 11367:2010 - Building acoustics - Acoustic classification of residential units - Field evaluation and verification (in Italian).
- [3] R. Cremonini, S. Secchi and P. Fausti, "The Italian standard UNI 11367 regarding the sound classification of single properties: overview of procedures". Proceedings of 2010 EAA Symposium on Harmonization of European Sound Insulation Descriptors and Classification Standards, Florence, (2010).
- [4] Di Bella A., Fausti P., Scamoni F., Secchi S., Italian experiences on acoustic classification of buildings, Proceedings of Inter Noise 2012, New York City, August 19-22, 2012; Copyright©2012, The Institute of Noise Control Engineering of the USA, Inc., Washington, DC.
- [5] UNI 11444:2012 - Building acoustics - Acoustic classification of residential units - Guidelines for the selection of housing units in non-serial buildings (in Italian).
- [6] [www.istat.it](http://www.istat.it)
- [7] Corrado V., Ballarini I., Corgnati S. P., Typology Approach for Building Stock Energy Assessment - National scientific report on the TABULA activities In Italy, Politecnico di Torino, Italy, ISBN: 978-88-8202-039-2, May 2012, <http://www.building-typology.eu/>
- [8] <http://en.wikipedia.org/wiki/Italy>
- [9] Proceedings of Florence EAA-COST Symposium (14-12-2010) [http://www.acustica-aiia.it/AIA\\_EAA\\_COST\\_FLORENCE\\_2010/index\\_eng.html](http://www.acustica-aiia.it/AIA_EAA_COST_FLORENCE_2010/index_eng.html)
- [10] Fausti, P., Secchi, S., "Statistical analysis of Sound Reduction Index measurements on typical Italian lightweight concrete block walls", Proceedings of Euronoise 2012, Prague, (2012).
- [11] Fausti P., Ingelaere B., Smith R.S., Steel C., «Common errors during construction of new buildings and effect of workmanship». Proceedings of European

Symposium of EAA TC-RBA and COST Action TU0901, Firenze (2010), ISBN 978-88-88942-32-2.

- [12] Nannipieri, E., Secchi, S., The Evolution of Acoustic Comfort in Italian Houses. In Building Acoustics, Vol. 19, n. 2, 2012.
- [13] <http://www.costtu0901.eu/>
- [14] A. Di Bella, C. M. Pontarollo, M. Vigo, "Comparison between European acoustic classification schemes for dwellings based on experimental evaluations and social surveys", Proceedings of Euronoise 2012, Prague, (2012).



# Building acoustics throughout Europe

## Volume 2: Housing and construction types country by country

# 14

## Lithuania

Authors:

**Vidmantas Dikavicius<sup>1</sup>**  
**Kestutis Miskinis<sup>2</sup>**

<sup>1</sup> Institute of Architecture and Construction  
of Kaunas University of Technology, Kaunas, Lithuania  
e-mail: [dvidmantas@gmail.com](mailto:dvidmantas@gmail.com)

<sup>2</sup> Institute of Architecture and Construction  
of Kaunas University of Technology, Kaunas, Lithuania  
e-mail: [kesto.m@gmail.com](mailto:kesto.m@gmail.com)



## CHAPTER

## 14

## Lithuania

## 14.1. Design and acoustical performance: Lithuania

### 14.1.1. Overview of housing stock

Lithuania has about 3 million inhabitants in 2013 according to National Statistical department [1]. The most populated cities are given in Table 14.1 [1].

**Table 14.1.** Top 5 cities' population in Lithuania (data 2013).

City	Population
Vilnius	526 356
Kaunas	306 888
Klaipėda	158 541
Šiauliai	106 470
Panevėžys	97 343

The housing stock of new buildings in Lithuania is given in Table 14.2 [1].

**Table 14.2.** Housing stock in Lithuania (data 2010).

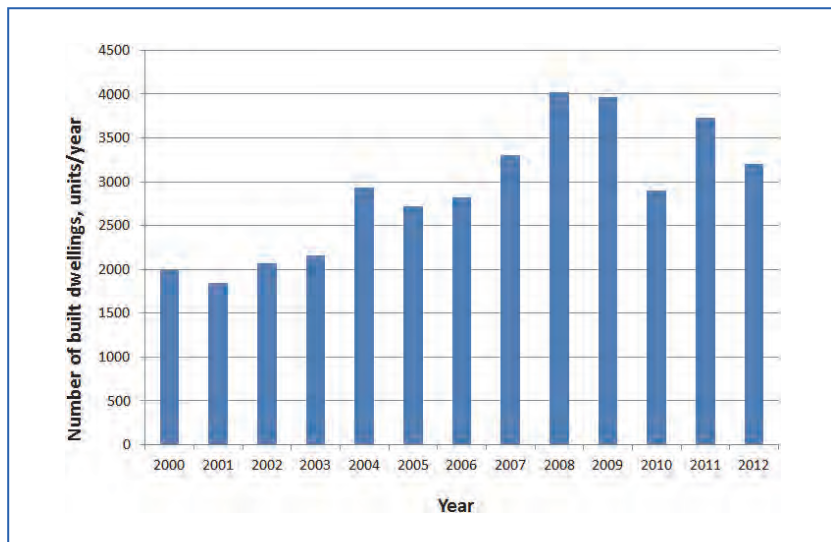
HOUSING STOCK	Number of dwellings	%
<b>Total Housing</b>	<b>1 274 600</b>	<b>100</b>
Flats/Maisonnettes	791 000	62.0
Attached houses	61 100	4.8
Houses (detached)	422 500	33.2

The number of dwellings built per year in Lithuania in the period 2000-2012 is given in figure 14.1 [1].

### 14.1.2. New build housing constructions

#### Wall constructions

The most popular type of separating walls between flats is heavyweight double wall [2 - 4]. The wall consists of three layers: two leaves of block or



**Figure 14.1.** Number of built dwellings per year.

brick masonry and air gap filled with mineral wool. Heavyweight single wall and heavyweight single wall with additional layers are also used. The walls are rendered with sand/cement plaster on both sides. A thin (4-10 mm of thickness) resilient material layer is laid under the wall (Figure 14.2). The wall is built so that the gap of 20-40 mm is left between the wall top and the upper slab which is filled with resilient material (usually mineral wool) (figure 14.2). The layer of resilient material is also inserted between the separating wall and façade (figure 14.3).

The thickness of double wall masonry leaves varies from 80 to 150 mm and the gap between them is from 50 to 100 mm. This gap is usually fully filled with low density (about  $30 \text{ kg/m}^3$ ) mineral wool. Sometimes the gap can be partly filled, for example 60 mm width gap: 10 mm air + 50 mm mineral wool. The leaves of the heavyweight double wall are not connected with each other but they are separately reinforced by wire net laid on every third row. The separating wall is also connected with flanking walls using metallic sticks.

The heavyweight double masonry walls are usually made from:

- Expanded clay concrete blocks (density  $800 \text{ kg/m}^3$ );
- Aerated concrete blocks (density  $600 \text{ kg/m}^3$ );



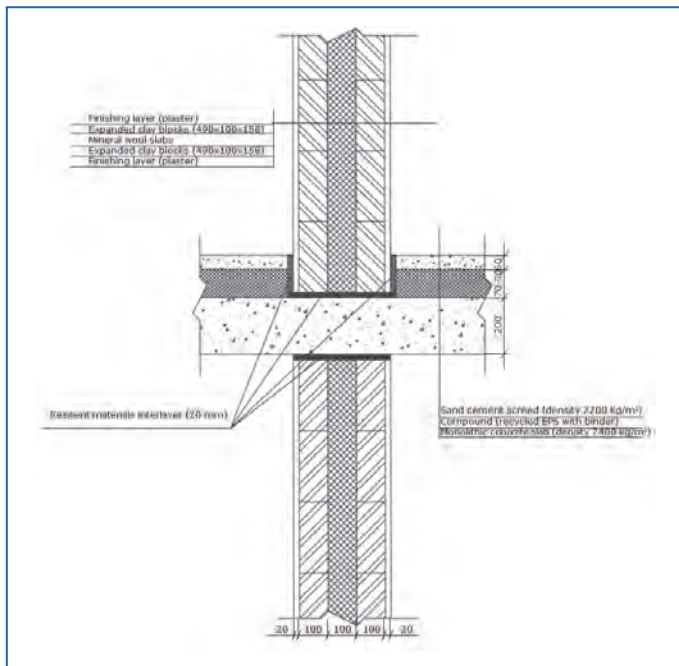


Figure 14.2. Separating wall connection with separating floor.

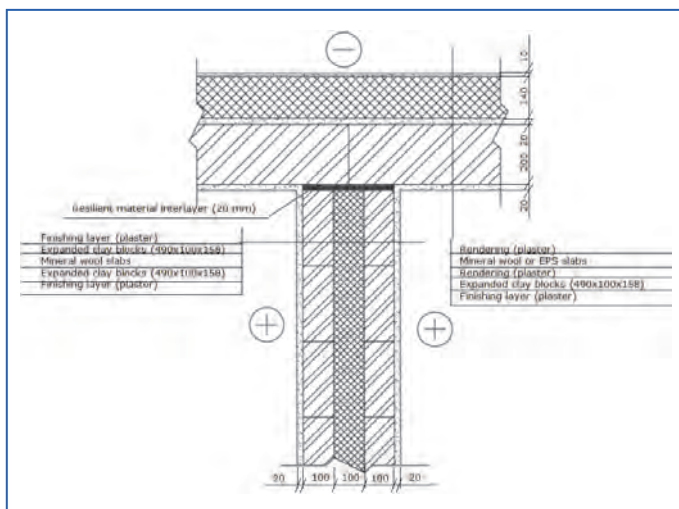
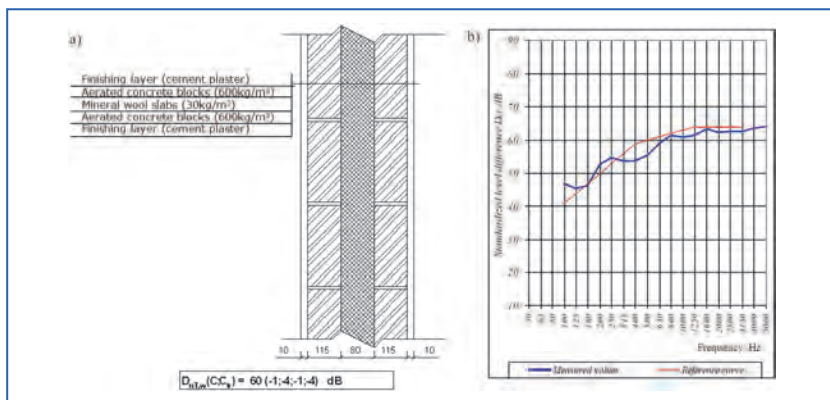


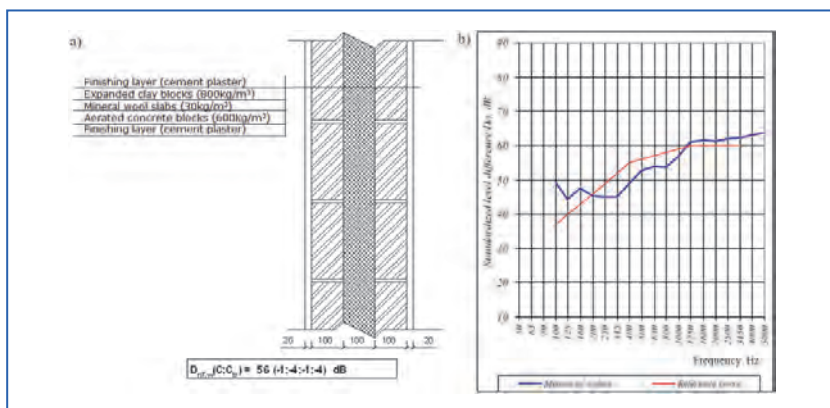
Figure 14.3. Separating wall connection with façade.

- Silicate cavity (multicores) blocks (density 1600 kg/m<sup>3</sup>);
- Ceramic cavity (multicores) blocks (1400 kg/m<sup>3</sup>);
- Gypsum blocks (density 900 kg /m<sup>3</sup>).

Field tests of the airborne sound insulation showed that high sound insulation index values resulted ( $D_{nT,w} > 55$  dB) where the separating heavyweight double walls were built on a monolith concrete slab (figure 14.4 and figure 14.5).



**Figure 14.4.** Separating heavyweight double wall: a) cross-section of the wall, b) graph view of standardized level difference values.



**Figure 14.5.** Separating heavyweight double wall: a) cross-section of the wall, b) graph view of standardized level difference values.



When these walls are built on the hollow concrete slabs, the values of weighted airborne sound insulation index usually lies below 53 dB. Additional layers consisting of the metallic stud frame, mineral wool and plasterboard are added to the double wall in order to achieve index value >55dB.

For airborne sound insulation also heavyweight single walls are used in dwellings as separating walls.

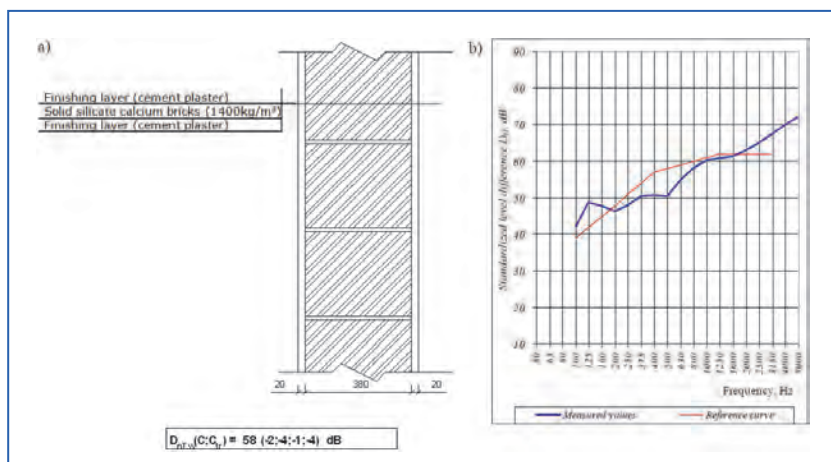
The single walls are made from:

- Ceramic cavity (multicores) blocks (density 1400 kg/m<sup>3</sup>);
- Solid silicate bricks (density (density 1700 kg/m<sup>3</sup>);
- Silicate cavity (multicores) blocks (density 1600 kg/m<sup>3</sup>);
- Expanded clay concrete blocks (density 800 kg/m<sup>3</sup>);

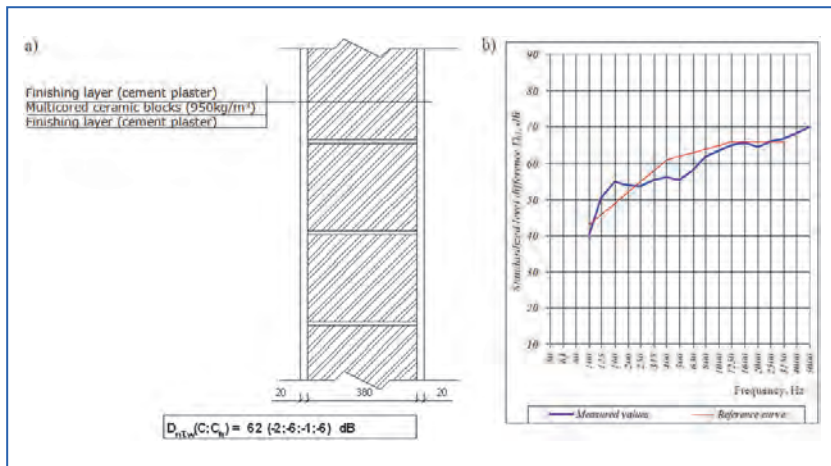
Both sides of the separating wall are finished with sand/cement plaster of 15-20 mm thickness. The thickness of such wall varies from 250 to 380 mm.

Again performing a field test of these walls resulted in high sound insulation index values ( $D_{nT,w} > 55$  dB) (figure 14.6 - 14.8).

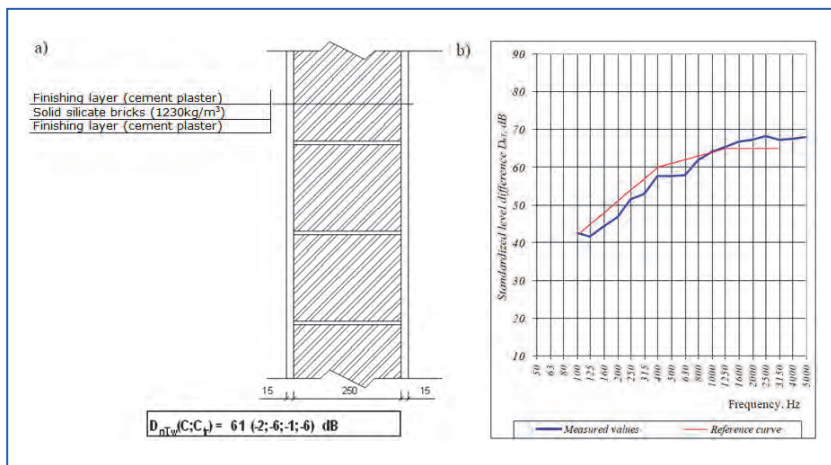
The single heavyweight walls could also be used with additional layers. On one side of the wall a metallic frame is added which is filled with low



**Figure 14.6.** Separating heavyweight single wall: a) cross-section of the wall, b) graph view of standardized level difference values.



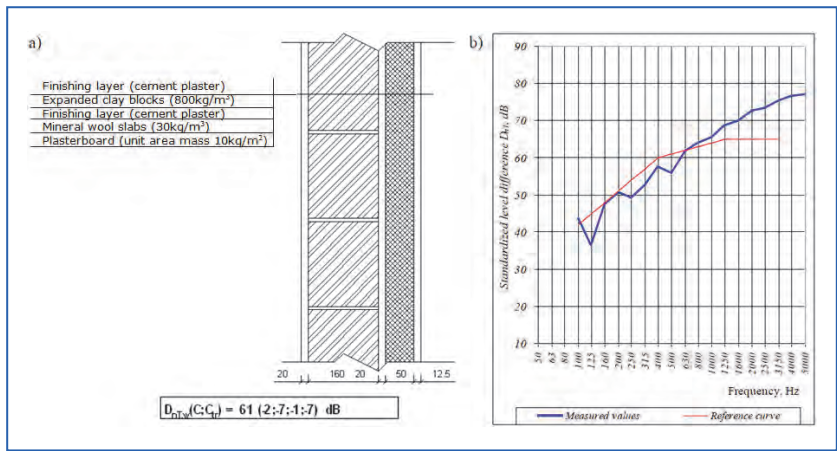
**Figure 14.7.** Separating heavyweight single wall: a) cross-section of the wall, b) graph view of standardized level difference values.



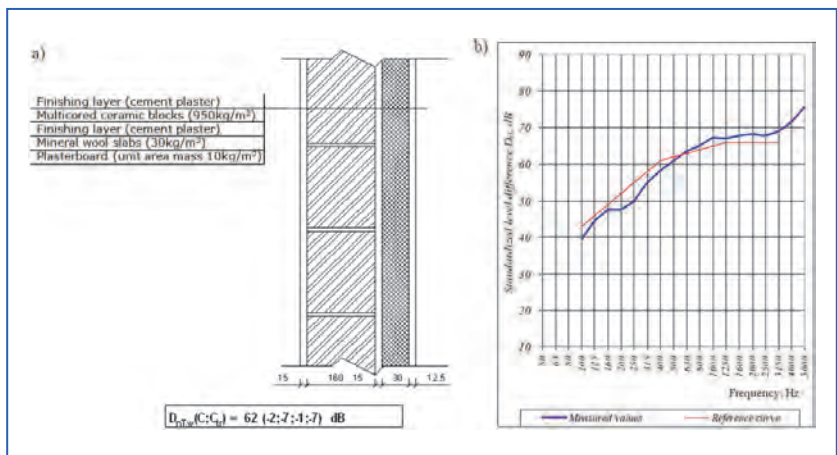
**Figure 14.8.** Separating heavyweight single wall: a) cross-section of the wall, b) graph view of standardized level difference values.

density (about 30 kg/m<sup>3</sup>) mineral wool. On the frame the plasterboards (one or two layer) of 12.5 mm thickness is screwed.

The values of the weighted sound insulation index of these walls are  $D_{nT,w} > 55 \text{ dB}$  (figure 14.9 and figure 14.10).



**Figure 14.9.** Separating heavyweight single wall with additional layers:  
a) cross-section of the wall, b) graph view of standardized level difference values.



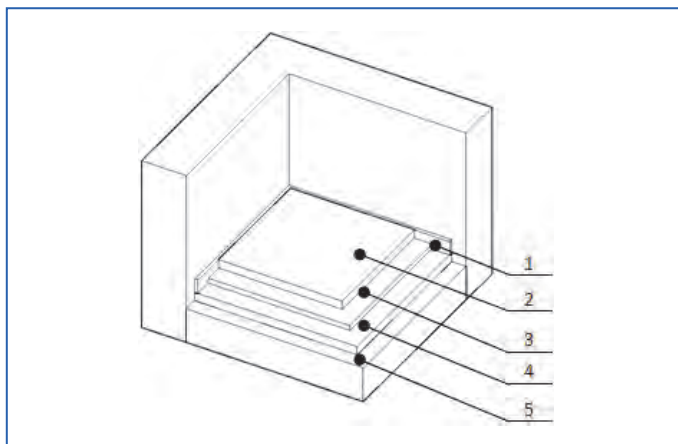
**Figure 14.10.** Separating heavyweight single wall with additional layers:  
a) cross-section of the wall, b) graph view of standardized level difference values.

### Floor constructions

Heavyweight concrete based floor constructions are used in Lithuania [5 - 8]. The floor consists of three main elements: base floor, sand/cement screed ("float") and resilient material interlayer between them. Two types of base floor are used in buildings: I – hollow prefabricated reinforced



concrete slabs; II – monolithic solid reinforced concrete slabs (made in situ). The thickness of the hollow concrete slab is usually 220 mm and for the monolithic one – 200 mm. The minimal mass per unit area of a hollow concrete slab is 300 kg/m<sup>2</sup> and of a monolithic slab – 460 kg/m<sup>2</sup> and the minimal mass per unit area of screed is 110 kg/m<sup>2</sup> (thickness 50 mm). The screed is reinforced with fibre (metallic, plastic or polypropylene) or a metallic reinforcement net. The sand/cement screed is separated from the base floor and flanking walls by resilient material (Figure 14.11). Mineral wool is mostly used as the resilient material.

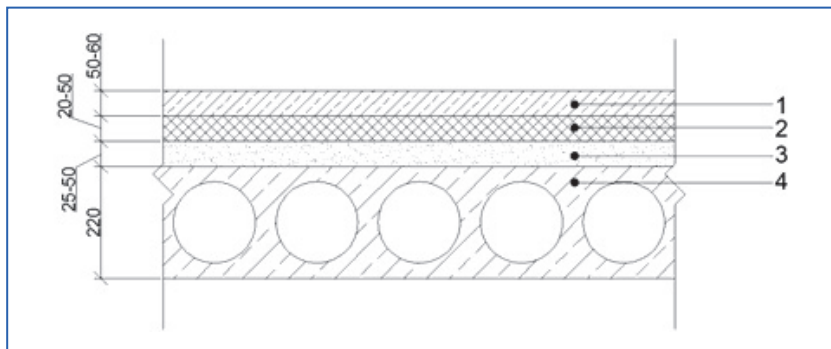


**Figure 14.11.** Isometric view of floor construction. 1) resilient material strip, 2) sand/cement screed, 3) resilient material interlayer, 4) loose-fill material interlayer, 5) concrete floor base.

Mineral wool, elasticized polystyrene and compound from recycled styropor granules as resilient materials layers are used. The thickness of this layer varies from 20 to 50 mm (mineral wool and elasticized polystyrene) and from 70 to 100 mm (compound of recycled styropor). The density of mineral wool is 100-120 kg/m<sup>3</sup>, elasticized polystyrene - 12-16 kg/m<sup>3</sup> and hardened compound from recycled styropor granules - 70-80 kg/m<sup>3</sup>. When a pipeline is fitted on the slab loose-fill material of sand or expanded clay as interlayer is used (usually 50 mm of thickness). Bulk density of sand is  $\geq 1650$  kg/m<sup>3</sup> and expanded clay  $\geq 450$  kg/m<sup>3</sup>. The airborne sound insulation varies in the range from 55 dB to 65 dB and impact sound insulation accordingly from 46 dB to 53 dB when hollow reinforced concrete slab is used. The airborne sound insulation varies in

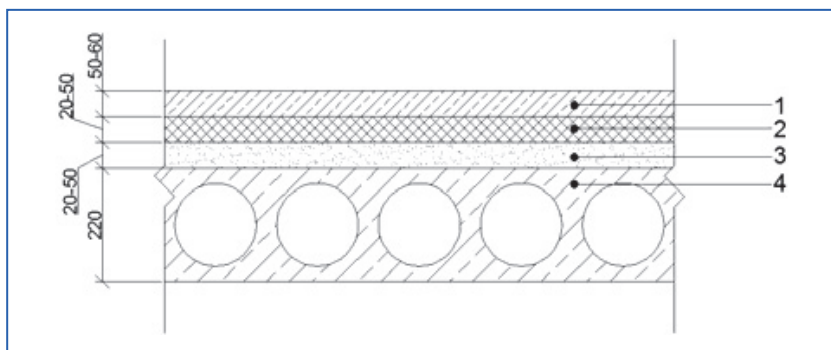


the range from 61 dB to 69 dB and impact sound insulation accordingly from 42 dB to 46 dB when monolithic solid reinforced concrete slab is used. The sound insulation descriptors' values of most recent floor constructions according to the field test data gathered during 2004 - 2010 years are presented in figures 14.12-14.17.



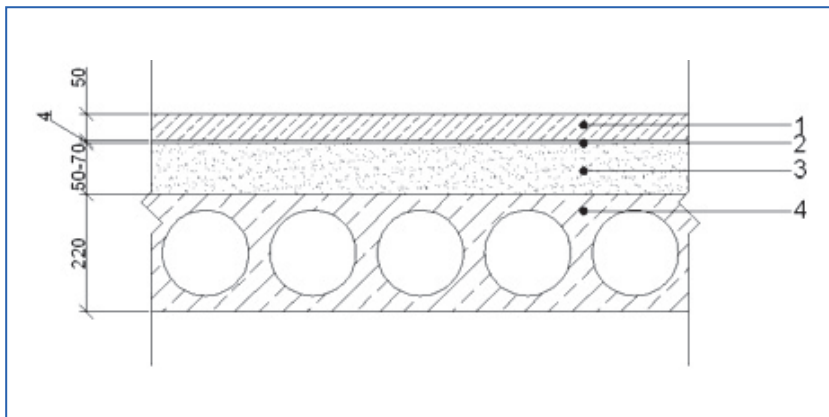
**Figure 14.12.** Floor construction "I-type". 1) sand/cement screed, 2) mineral wool, 3) sand, 4) reinforced hollow concrete slab.

The airborne sound insulation descriptor values are 55-59 dB, impact sound insulation – 47-50 dB.



**Figure 14.13.** Floor construction "II-type". 1) sand/cement screed, 2) mineral wool, 3) expanded clay, 4) reinforced hollow concrete slab.

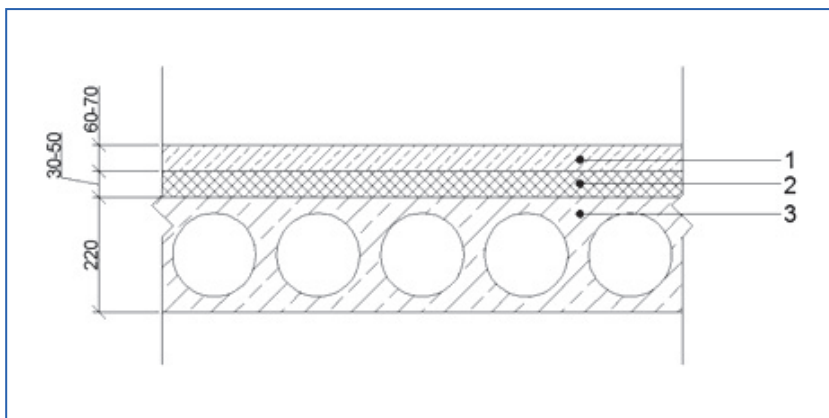
The airborne sound insulation descriptor values are 60-63 dB, impact sound insulation – 42-50 dB.



**Figure 14.14.** Floor construction "III-type".

- 1) sand/cement screed, 2) mineral wool mat,
- 3) sand, 4) reinforced hollow concrete slab.

The airborne sound insulation descriptor values are 61-65 dB, impact sound insulation – 49-51 dB.

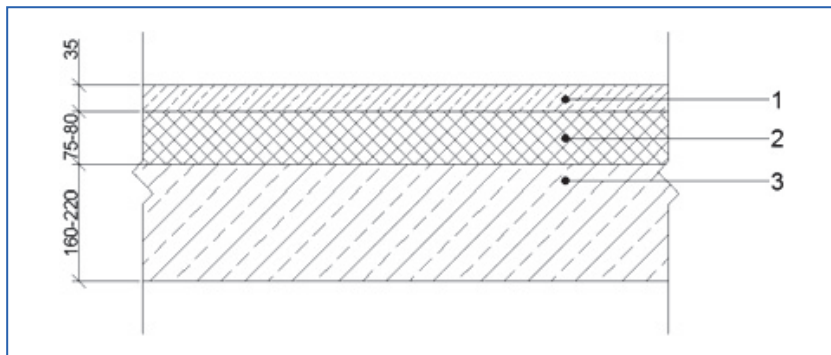


**Figure 14.15.** Floor construction "IV-type".

- 1) sand/cement screed, 2) mineral wool,
- 3) reinforced hollow concrete slab.

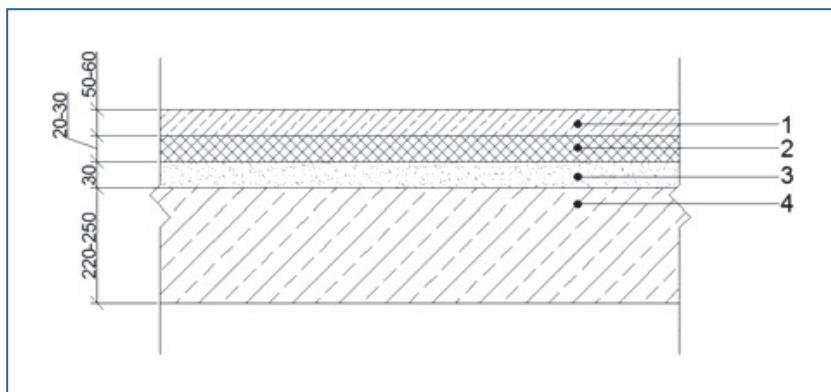
The airborne sound insulation descriptor values are 58-63 dB, impact sound insulation – 49-53 dB.





**Figure 14.16.** Floor construction "V-type". 1) sand/cement screed, 2) compound from recycled styropor granules, 3) reinforced monolithic concrete slab.

The airborne sound insulation descriptor values are 59-63 dB, impact sound insulation – 49-53 dB.



**Figure 14.17.** Floor construction "VI-type". 1) sand/cement screed, 2) mineral wool, 3) sand, 4) reinforced monolithic concrete slab.

The airborne sound insulation descriptor values are 61-69 dB, impact sound insulation – 42-50 dB.

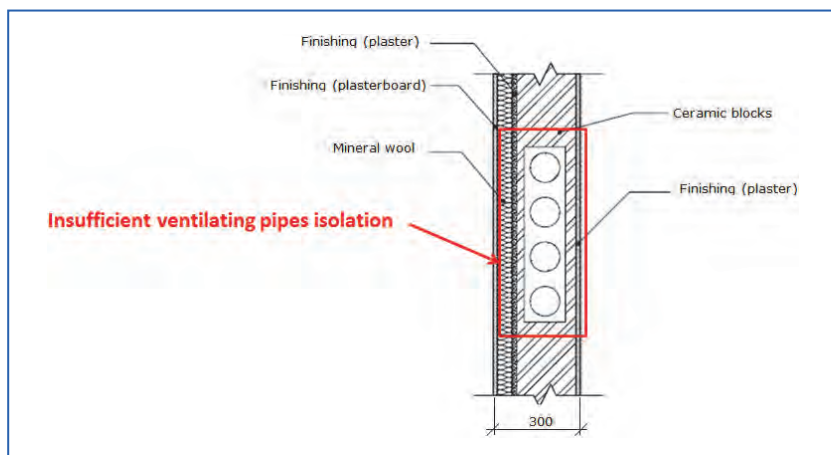
### *Errors influencing sound insulation*

Due to the fact that there are no catalogues of constructions for sound insulation design and/or workmanship errors occur. The most common workmanship and design errors are given below.



### Workmanship errors

One of the most common workmanship and/or design error is associated with ventilation pipes. These pipes are sometimes not isolated from each other and therefore sound can travel from one flat to another via pipes which come from different flats (figure 14.18). Sound can also be reflected from a covering over a ventilation pipe; the sound is reflected and therefore travels down a neighbouring pipe to another flat. This error can be solved by isolating one pipe from another and using special absorbent materials on the pipe coverings.



**Figure 14.18.** Cross section (horizontal) of separating wall between flats.

The second typical error is sound bridges between floating floor screed and separating walls. These sound bridges occur when mortar falls in the gap between sand/cement screed and separating wall (figure 14.19). This error can be avoided by increasing workmanship control and quality.

The third error is incorrect heating pipes installation. Heating pipes are not good enough isolated when they cross sand/cement screed due this we have sound bridges for impact noise (figure 14.20). This can be solved using resilient material and soft connectors between pipe and heater.

### Design errors

Design errors are mostly associated with the location of rooms in a building, if rooms with different purposes have a direct connection between each

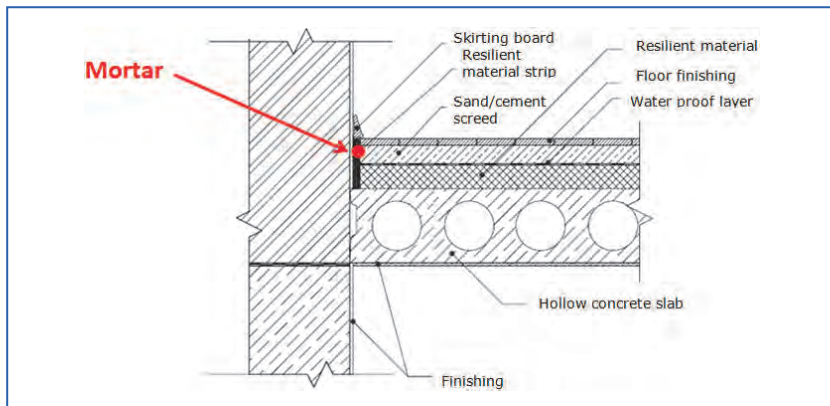


Figure 14.19. Cross section (vertical) of floor.

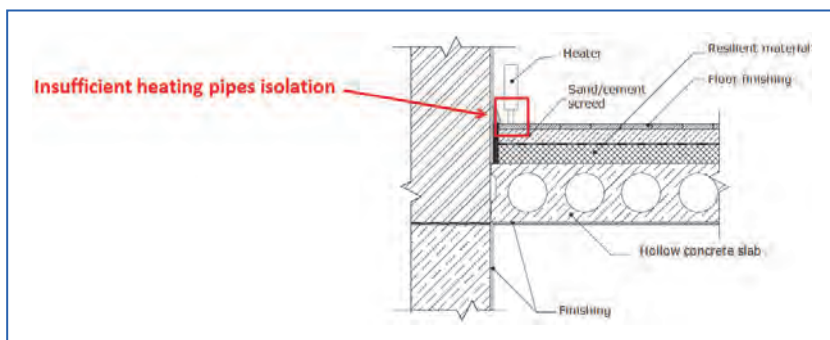


Figure 14.20. Cross section (vertical) of floor.

other through a separating wall. A typical situation could be when a noisy room is located next to quiet room (figure 14.21): a kitchen with a living room in flat No. "1" is blocked with a quiet room (bedroom) in flat No. "2". This means that people may not have normal rest due to the noise coming from neighbour's activities in kitchen. To solve this during the design stage it should be done so that the quiet rooms are blocked together (bedroom with bedroom) and noisy rooms as well (kitchen with kitchen).

The second group of design errors are constructional solutions (figure 14.22):

- Stair construction is not separated from the common wall with rooms of Flata "1".

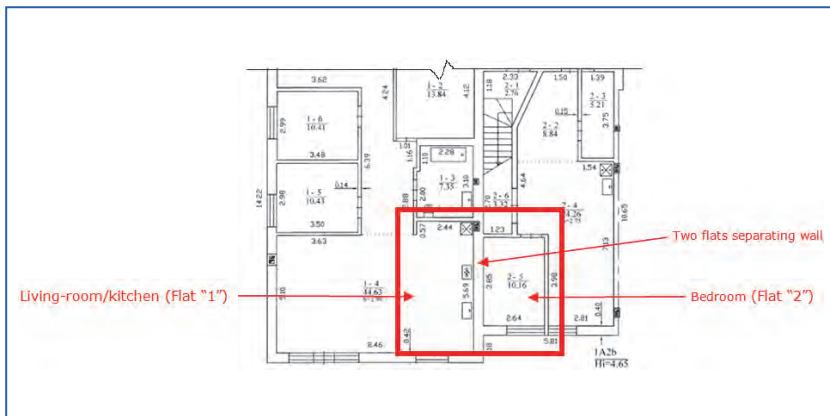


Figure 14.21. Plan of dwelling.

- Ventilation channels are situated near each other in one cluster which reduces sound insulation between flats in different floors.

This means that people living in flat “1” hear noises caused by footsteps of persons walking up or down the stairs. The ventilation situated in close vicinity to others rise possibility for any noise to travel from one flat via a ventilation channel up to the cover over the ventilation well that is then reflected by it to return to another flat which reduces insulation between flats situated on different floors.

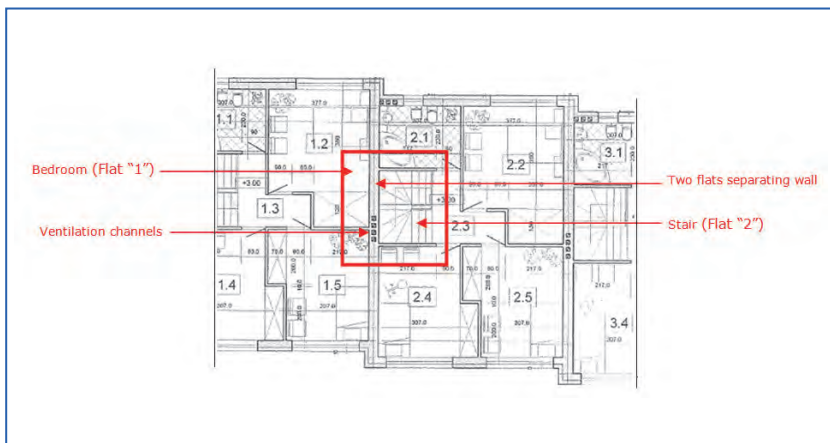


Figure 14.22. Plan of dwelling.



### 14.1.3. Existing housing

The buildings built during the last 60 years can be divided into three periods:

- First period 1940-1959;
- Second 1960-1989;
- Third 1990-2003.

#### *Period: 1940-1959*

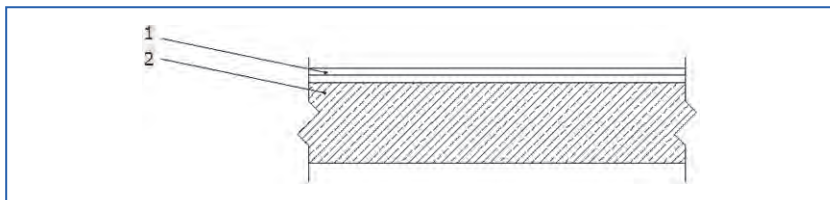
Typical buildings of this period are shown In figure 14.23. During this period there were no regulations for design and acoustical classification. Due to this no acoustic measurements were performed either.



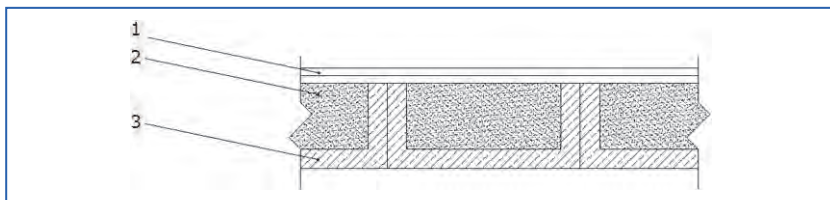
**Figure 14.23.** Typical buildings in 1940-1959 period.

These are typical constructions used during this period:

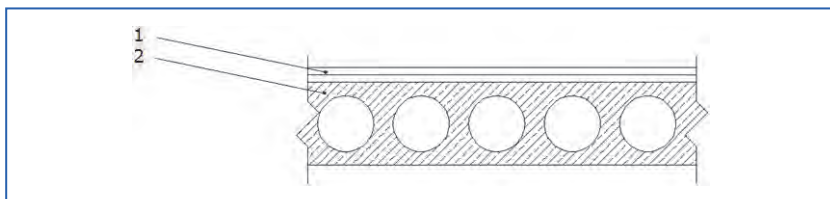
- Floor: monolithic concrete slabs with steel beams; precast concrete slabs; ceramic blocks with monolithic concrete (Figure 14.24-14.26);
- Party wall: ceramic or silicate bricks, blocks (Figure 14.27);
- Inner wall: ceramic or silicate bricks, blocks (Figure 14.27);



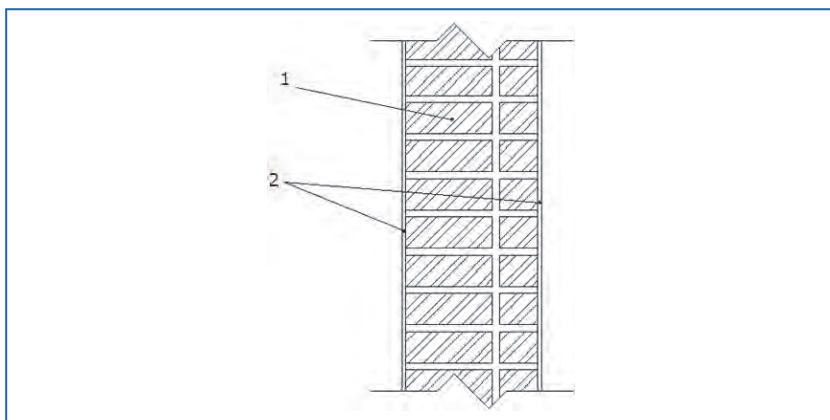
**Figure 14.24.** Floor. 1) Wooden floor; 2) 200 mm monolithic concrete slab.



**Figure 14.25.** Floor. 1) Wooden floor; 2) clinker; 3) 300 mm concrete blocks.



**Figure 14.26.** Floor. 1) Wooden floor; 2) 220 mm precast hollow concrete slab.

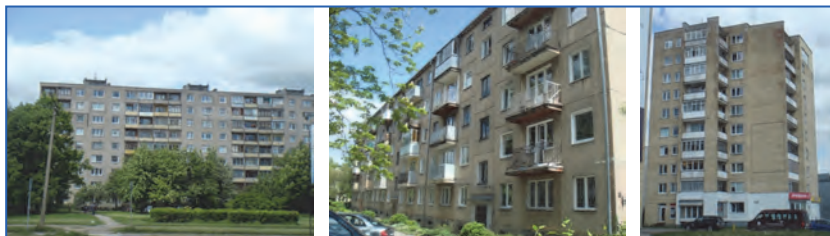


**Figure 14.27.** Wall. 1 – 380 mm ceramic or silicate brick; 2 – finishing.



### Period: 1960-1989

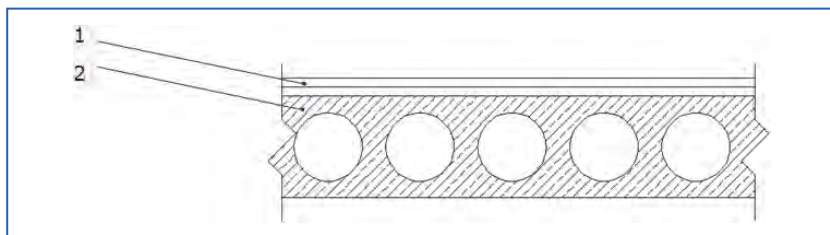
Typical buildings of this period are shown in figure 14.28. During this period the norm СНИП-II-12-77 (in 1977) for design was released but there were no acoustical classification requirements. Due to this there were no acoustical measurements performed.



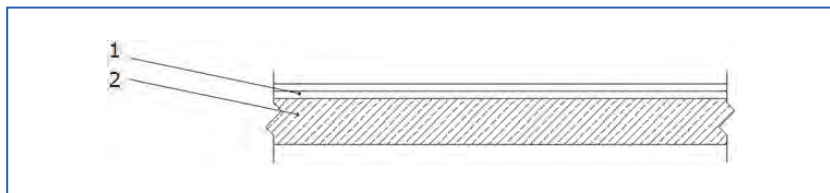
**Figure 14.28.** Typical buildings in 1960-1989 period.

The Typical constructions used during this period:

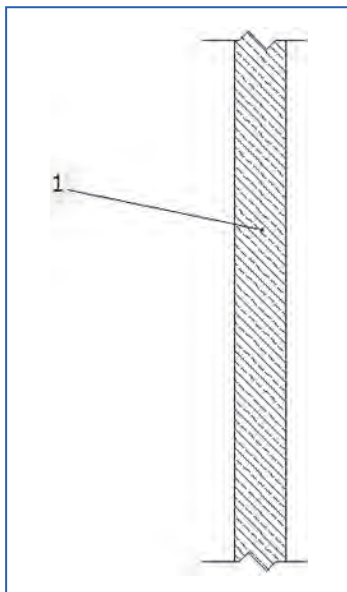
- Floor: concrete panels; precast concrete slabs (Figure 14.29-14.30);
- Party wall: concrete panels, ceramic or silicate bricks (Figure 14.31-14.32);
- Inner wall: concrete panels, ceramic or silicate bricks (Figure 14.31-14.32);



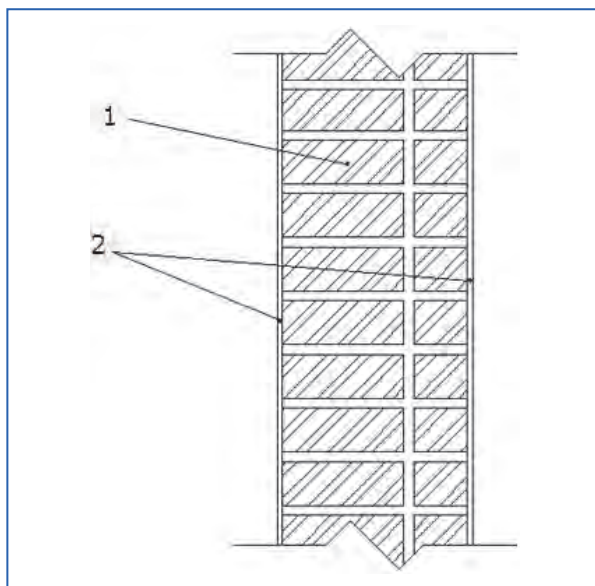
**Figure 14.29.** Floor. 1) Wooden floor; 2) 220 mm precast hollow concrete slab.



**Figure 14.30.** Floor. 1) Wooden floor; 2) 120-160 mm precast concrete panel.



**Figure 14.31.** Wall. 1) 120-160 mm precast concrete panel.



**Figure 14.32.** Wall. 1) 380 mm ceramic or silicate brick; 2) finishing.





### Period: 1990-2003

Typical buildings of this period are shown in figure 14.33. During this period the norm СНИП-II-12-77 (in 1977) for design was still valid, but still no acoustical classification requirements existed and no measurements were performed.



**Figure 14.33.** Typical buildings in 1990-2003.

The Typical constructions used during this period (see figures of previous period):

- Floor: precast concrete slabs
- Party wall: ceramic or silicate bricks
- Inner wall: ceramic or silicate bricks

## 14.2. Conclusion

In Lithuania the regulation for sound insulation STR.2.01.07:2003 [9] was accepted in 2003 and is valid from 2004. From this date the measurements became mandatory, but only in new buildings which were designed after this date. For old building built before 2004 there are no requirements and no sound insulation measurements performed.

## 14.3. References

- [1] <http://www.stat.gov.lt/en/home> (Statistics Lithuania).
- [2] Technical approval TL-01-028:2006 " Internal separating walls from expanded clay blocks "FIBO 5" and stone wool PAROC UNS 37z". (in Lithuanian).
- [3] Technical approval NTL-01-052:2009 "Multi-layered internal walls from expanded clay blocks FIBO with Isover mineral wool for airborne sound insulation". (in Lithuanian).
- [4] V. Dikavicius, K. Miskinis. Acoustical performance of new building separating elements in Lithuania. European Symposium Harmonization of European

Sound Insulation Descriptors and Classification Standards Florence, December 14th 2010.

- [5] Technical approval TL-01-021:2006 "Sound insulating concrete base floor constructions with stone wool slabs PAROC SSB1", (in Lithuanian).
- [6] Technical approval TL-01-020:2008 "Sound insulating concrete base floor constructions with ISOVER mineral wool slabs", (in Lithuanian).
- [7] Technical approval TL-01-047:2007 "Sound insulating concrete base floor constructions with sound insulating mat SK3", (in Lithuanian).
- [8] Kestutis Miskinis, Vidmantas Dikavicius. Heavyweight Floor Constructions for Sound Insulation in New Buildings in Lithuania. Proceeding of FORUM ACUSTICUM 2011, 27. June - 1. July, Aalborg.
- [9] Regulation STR.2.01.07:2003 "Protection of inside and outside environment of buildings against noise". Annex 1. (in Lithuanian).



# Building acoustics throughout Europe

## Volume 2: Housing and construction types country by country

# 15

## Macedonia

Author:  
**Todorka Samardzioska**

Associated Professor, Faculty of Civil Engineering, UKIM, Skopje, Macedonia  
e-mail: [samardzioska@gf.ukim.edu.mk](mailto:samardzioska@gf.ukim.edu.mk)



## CHAPTER

## 15

## Macedonia

## 15.1. Design and acoustic performance

### 15.1.1. Overview of housing stock

The Republic of Macedonia occupies a land area of 25.713 km<sup>2</sup>, with a population of 2.022.547 according to the last census of 2002. The last official estimate from 2012, without significant change, gives a figure of 2.062.294 inhabitants. Macedonia is a multi-ethnic country and the ethnic affiliation of the population is: 64.18% are Macedonians, 25.17% are Albanians, 3.85% are Turks, 2.66% are Roma [Gypsy], 1.78% are Serbs, and 2.02% are other ethnic groups.

#### *The quantities of housing stock and total population*

The building industry and the existing housing assets present a good base for further development of the real estate market. There are 697.529 dwellings in the country, according to the 2002 census, with total area of 49.671.709 m<sup>2</sup>. The largest part of the dwellings, almost 94%, was built after 1945.

**Table 15.1.** Number of dwellings built after the Second World War.

Period	Number of dwellings
1945 – 1960	73.688
1961 – 1970	136.418
1971 – 1980	181.969
1981 – 1990	151.434
1991 – 2002	118.740
Total	662.249

Table 15.1 gives evidence that over 70% of the existing dwellings are built after the 70s and they are still in a good condition.

Typical examples of residential buildings in different construction periods are presented in Figures 15.1 and 15.2.



**Figure 15.1.** Architecture from: a) end of 19<sup>th</sup> century; b) 1950-60s.



**Figure 15.2.** Architecture from: a) 1970-80s; b) end of 20<sup>th</sup> century.

Due to the process of privatization and denationalization, 99% of the total dwellings in mid 1990s are private (690.961), while 1% (5420) are in governmental possession. According to the census statistics, 83% (579.184) of the total dwelling stock is occupied, 17% (65.096) is available on the real estate market.

### *The most populated cities*

More than one third of the total Macedonian population lives in the five largest cities or towns in Macedonia. The Table 15.2 below shows the

distribution of the population in those cities without their suburbia, according to the 2002 census.

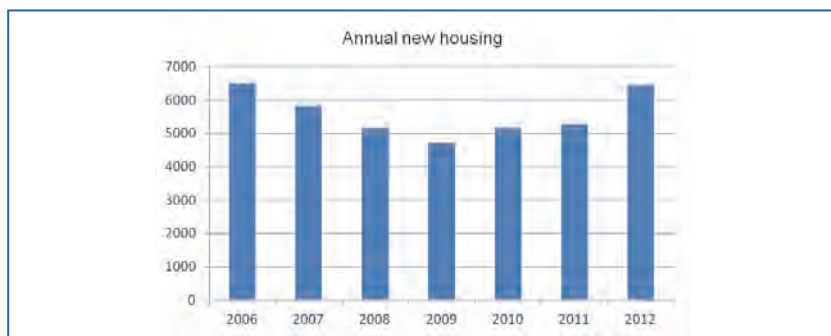
**Table 15.2.** Largest cities or towns in Macedonia.

no.	city	population
1	Skopje	506 926
2	Bitola	74 550
3	Kumanovo	70 842
4	Prilep	66 246
5	Tetovo	52 915

### *Proportion of apartments, terraced (row) and detached houses*

Approximately 60% of the total dwelling stock in Macedonia is mainly one or two storey single family detached houses. Only 2% are attached or row houses and the remaining 38% are multi-storey flats.

Figure 15.3 represents the typical number of new homes built per year in the country. In 2012 the number of 6433 new built homes was reached, similar as in the 2006 when the number of new housing output was 6493.

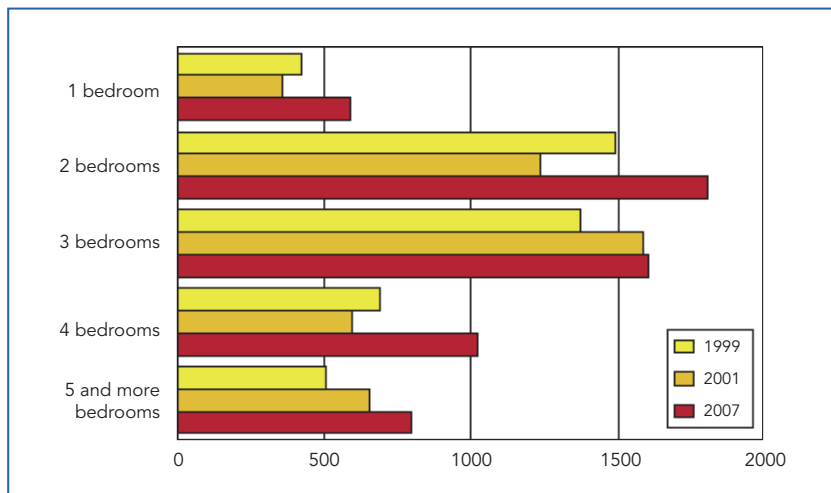


**Figure 15.3.** Typical annual new housing outputs.

As an typical example, figures of three different years have been presented to show typical facts of the building stock, 1999, 2001 and 2007. Apartments with three bedrooms represent 35,8% of the total new built



homes in 2001, 30,6% in 1999 and 27,6% in 2007. Two-bedroom apartments follow them representing 33,3% in 1999, 31,1% in 2007 and 27,9% in 2001. The total number of built apartments in 1999, 2001 and 2007 is shown in Figure 15.4.



**Figure 15.4.** Total number of built apartments.

### 15.1.2. New build housing constructions

#### *The legislation in building acoustics*

Measurements and testing of sound insulation in the dwellings are not mandatory in the Republic of Macedonia. National sound insulation requirements in a form of building code related to the sound insulation existed since 1982, as a regulation in the former S.F.R. Yugoslavia. The code includes minimal requirements for only two types of insulation: horizontal airborne sound insulation and vertical airborne and impact sound insulation, see Table 15.4. This was contained in the MKS U. J6.201 bylaw, which has been inherited from the old Yugoslav standard JUS.U.J6.201, adopted in 1982 and revised in 1989. The abovementioned MKS standard was withdrawn on 30.01.2012. Any adequate replacement of this standard has not been made up to this date. Anyhow, MKS EN ISO 140: Acoustics - Measurement of sound insulation in buildings and of building elements is a common practice currently.



**Table 15.3.** Requirements in MKS.U.J6.201 concerning sound insulation.

Position in building	Parameter	Value
Airborne sound insulation between rooms (vertical and horizontal)	$R'_w$	$\geq 52$ dB
Impact sound insulation (vertical)	$L'_{n,w}$	$\leq 60$ dB

However, there is experience of utilising field sound insulation measurements when investigating complaints, on demand of some investors or inhabitants.

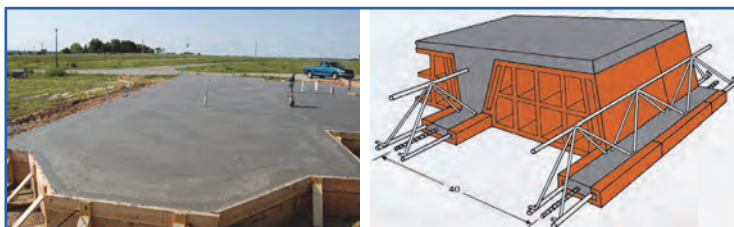
### Typical heavyweight constructions

The new residential buildings in Macedonia are mainly heavy constructions, composed of reinforced concrete skeleton systems with either block or brick walls or solid reinforced concrete walls, see Figure 15.5.



**Figure 15.5.** New buildings.

The most common floors are solid reinforced concrete slabs, or beam and block (semi – prefabricated) floors, type “Monta”, as presented in Figure 15.6. Lightweight constructions are usual within the dwellings, as partition walls between rooms in the dwelling.



**Figure 15.6.** Floor structures: a) solid reinforced concrete slab; b) beam and block floor (semi-prefabricated floor), type “Monta”.





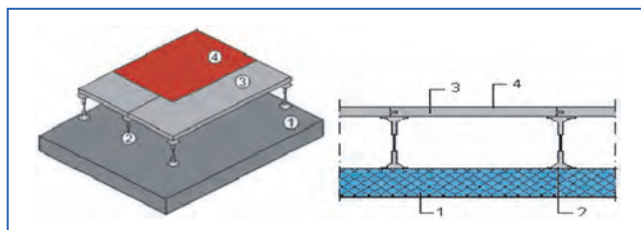
### Typical errors in design and workmanship

The following figures illustrate the typical errors in design, as the example with broken insulation in the Figure 15.7, when too many cables and pipes have to cross the floor.



**Figure 15.7.** Typical error in workmanship – broken insulation.

The Figure 15.8 represents one possible solution of the presented problem during the design phase, the raised floor.



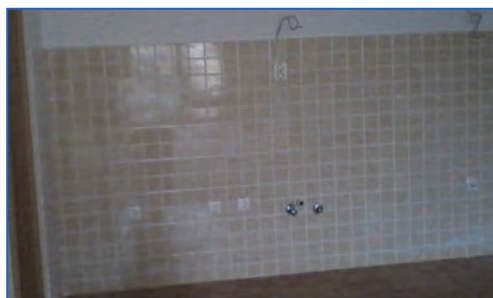
**Figure 15.8.** Possible solution when there are too many cables and pipes (1-reinforced concrete slab, 2-rods, 3-slab, 4-flooring).

New contemporary architecture, for example the buildings made of glass and steel, are not usually friendly oriented towards the good acoustic performance of the buildings, Figure 15.9.

Some of the most common typical errors in workmanship which diminish the airborne sound insulation are presented in the following figures: holes for installation services on the walls (Figure 15.10), lack of mortar in vertical joints between the bricks (Figure 15.11), or irregular thickness or lack of mortar on the surface layers (Figure 15.12).



**Figure 15.9.** Typical error in design – building envelope of steel and glass.



**Figure 15.10.** Typical error in workmanship – holes for installation services.



**Figure 15.11.** Typical errors in workmanship – irregular mortar layers.



**Figure 15.12.** Typical errors in workmanship – vertical joints not filled with mortar.

### 15.1.3. Existing housing

#### *Typical constructions found in existing stock*

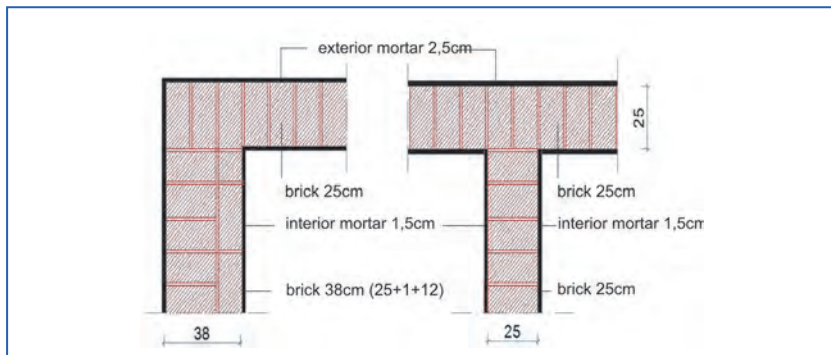
As all over the world, stone has been used as a building material for thousands of years in Macedonia as well. It has long been recognised as a material of great durability and superior artistic quality. Even though the use of stone in construction has declined over the last hundred years, it remained an aristocrat of building materials. Earth is one of the most abundant basic building materials. It is low technology, easily worked with simple tools, and yet it can be used by anyone to construct walls, floors and roofs of advanced architectural design. Up to the Second World War they were main building materials in Macedonia.

#### *Periods of building*

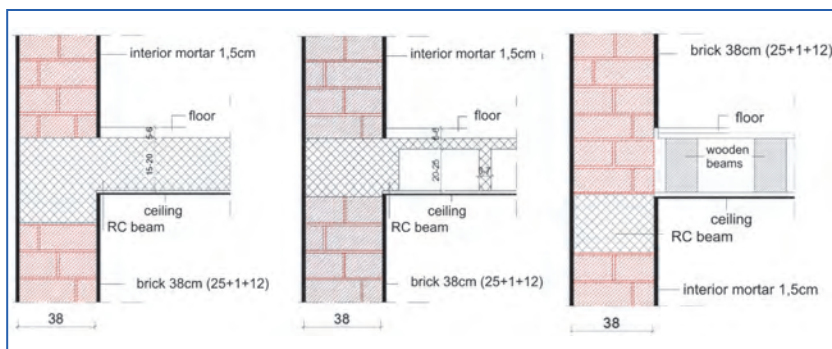
The structures which had been built during the past century, 50-ties and beginning of the 60-ties, in Macedonia used masonry building systems, mainly with solid brick structural walls 25-38 cm thick, without any insulation material. They lead to a huge consumption of energy for heating and cooling, and low sound insulation.

The floor structures built during that time were based on three main structural systems, as shown in Figure 15.14: monolithic reinforced concrete structure, beam and block floor (semi-prefabricated) system, type “Avramenko” and timber based floor structures supported by masonry bearing walls.

The earthquake in 1963 in Skopje introduced a completely new approach in the building. At that time, a lot of buildings suffered many structural damages or collapsed. The others were strengthened or repaired in various ways.



**Figure 15.13.** Example of building technology in 50-ties.



**Figure 15.14.** Floor structures: a) monolithic RC; b) semi-prefabricated system "Avramenko"; c) wooden floor.

New rigorous seismic regulations and building standards were introduced immediately after the 1963 earthquake. Reinforced concrete skeleton building systems with high quality were mostly used. At that time, precast reinforced concrete heavy-panels systems and semi-fabricated light ceramic floors with fine corrugation were introduced.

In the early 1970s Macedonia survived a radical change from traditional living in single family houses into collective multi-storey family houses. From the acoustics point of view, the use of massive brick wall construction and masonry does not create necessity for significant interventions in terms of noise protection. They beneficially contribute to the acoustic performance of buildings, see Figure 15.15.

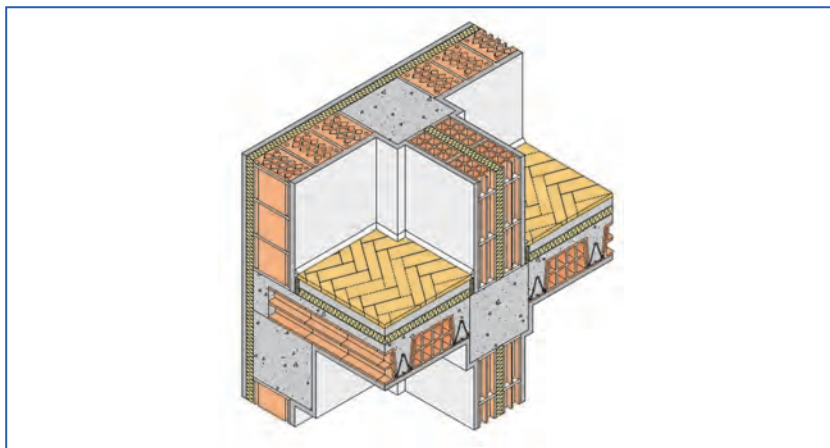


Figure 15.15. Example of current separating wall and floor construction in Macedonia.

Typical performance (sound insulation: values and graphs)

A sound insulation test is usually performed in the frequency range between 100 Hz to 3150 Hz. The corresponding weighted result for airborne or impact sound is presented as a single value. For the purposes of this study, field measurements of 18 different types of separating walls in residential buildings in Macedonia were carried out. The results and comparisons are summarized in the form of conclusions, observations, and recommendations for further research in this area.

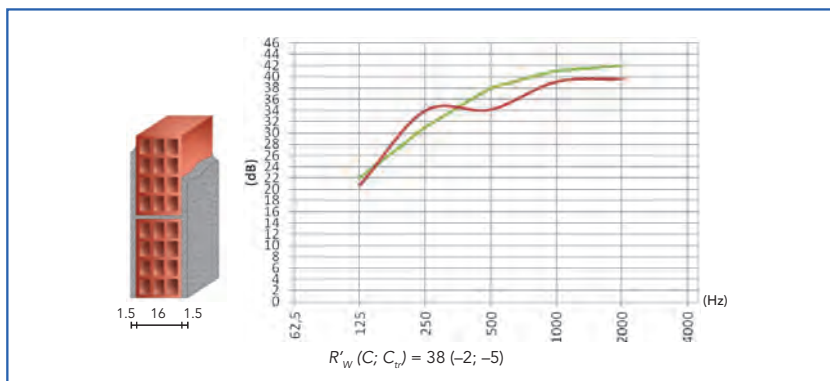
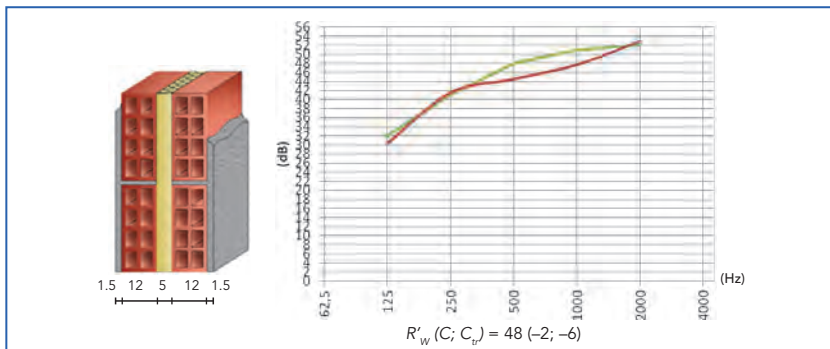
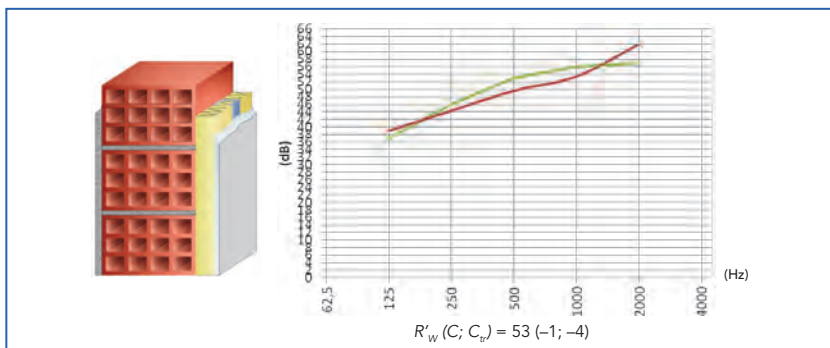


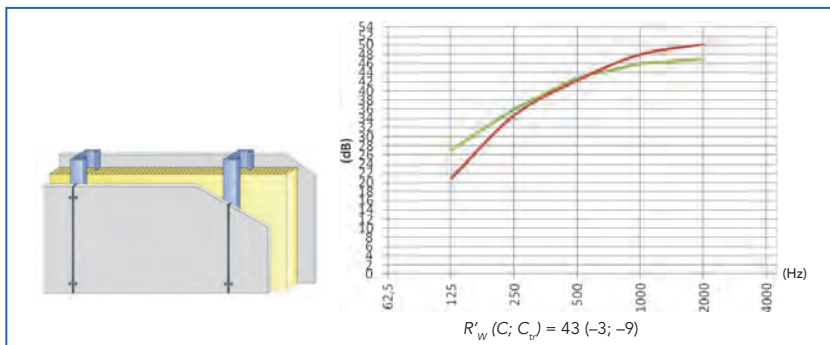
Figure 15.16. Airborne sound insulation of a ceramic block wall  $d=16$  cm.



**Figure 15.17.** Airborne sound insulation of 2 x 12 cm cellular clay block cavity wall with 5 cm cavity filled with mineral wool and coated on both faces with 1.5 cm mortar.



**Figure 15.18.** Airborne sound insulation of 25 cm cellular clay block, plasterboard on metal studs with 5 cm mineral wool and coated with 1.5 cm mortar on the other side.



**Figure 15.19.** Airborne sound insulation of a partition wall between bedrooms: plasterboards 2 x 1.25 cm on steel studs, with 7.5 cm mineral wool infilling.

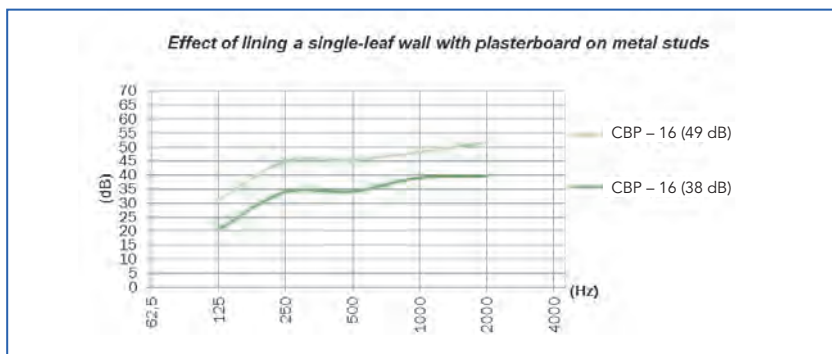


The gypsum lightweight partition shows great correspondence in the results, not only for single value sound reduction index, but for each frequency as well, while for the brick hollow walls there are bigger variations, especially for the high frequencies. This is due to the complex nature of the hollow blocks. Only two of the measured partition walls meet the requirements of MKS.U.J6.201 shown in Table 15.3. This is extremely disappointing, because the examined types of partition elements are the most common ones that can be found in our practice.

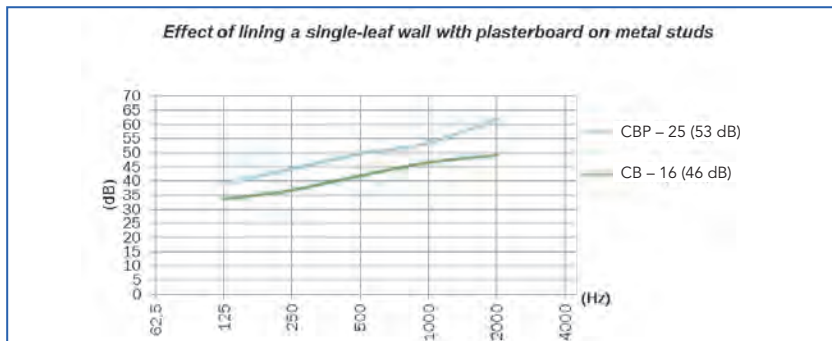
### Methods of improving sound insulation

There are many ways of improvement the acoustic performance of Macedonian existing buildings. That is generally based on the following points:

- improvement of airborne sound insulation between dwellings by means of wall linings with plasterboard, see Figures 15.20 and 15.21. In the case of a ceramic block wall 16 mm thick, the sound insulation increased 11 dB (from 38 to 49 dB). While in the case of ceramic block wall 25 cm thick, the increase in the sound insulation of the wall varied from 46 dB to 53 dB due to the plasterboard lining and layer of mineral wool.
- improvement of the impact sound insulation of floors with floating and raised floors
- replacement of windows and sealing of leakage between frame and glazing.



**Figure 15.20.** Improving sound insulation – Effect of lining a single-leaf ceramic block wall 16 cm thick with plasterboard on metal studs.



**Figure 15.21.** Improving sound insulation – Effect of lining a single-leaf ceramic block wall 25 cm thick with plasterboard on metal studs.

## 15.2. Conclusion

Since the current approach of building heavyweight single-leaf separating walls is inadequate in terms of sound insulation, there is a need for changing the design concept, i.e. heavy single leaf partitions should be replaced with lightweight double wall partitions.

Publishing an official catalogue with technical features of partition elements which meet the minimum sound insulation requirements, is recommended to facilitate building and design procedures.

Furthermore, the current state-of-the-art in building acoustics in Macedonia urges the approval of building regulations which will set airborne and impact sound insulation requirements that each building will have to satisfy. With this approach, the designing of partition elements would be smooth and satisfactory, which will enable the contemporary people to carry out their daily activities without disturbing their comfort due to the unwelcomed sounds from the noisy environment

## 15.3. References

- [1] Government of the Republic of Macedonia. "2002 census results" ([www.stat.gov.mk/pdf/kniga\\_13.pdf](http://www.stat.gov.mk/pdf/kniga_13.pdf)).
- [2] MKS U.J6.201:1989 – "Technical requirements for designing and constructing of buildings"
- [3] COST C16 "Improving the Quality of Existing Urban Building Envelopes"
- [4] <http://www.costtu0901.eu/>
- [5] [http://en.wikipedia.org/wiki/Republic\\_of\\_Macedonia](http://en.wikipedia.org/wiki/Republic_of_Macedonia)





# Building acoustics throughout Europe

## Volume 2: Housing and construction types country by country

# 16

## Malta

Authors:

Vincent Buhagiar<sup>1</sup>

Noella Cassar<sup>2</sup>

Dept. of Environmental Design,  
Faculty for the Built environment,  
University of Malta, Msida, Malta.

<sup>1</sup> e-mail: [vincent.buhagiar@um.edu.mt](mailto:vincent.buhagiar@um.edu.mt)

<sup>2</sup> e-mail: [noella.cassar@um.edu.mt](mailto:noella.cassar@um.edu.mt)



## CHAPTER

## 16

## Malta

## 16.1. Introduction

Malta consists of an archipelago of three main inhabited islands and a few smaller uninhabited ones. Malta, Gozo and Comino have a total area of 1,282 km<sup>2</sup>, accommodating a population of just over 400,000, collectively termed Malta. This makes it the 6th densest country in the world and 11 times greater than the EU average. As one entity, Malta, following its independence from the United Kingdom in 1964, and becoming a democratic republic in 1974, joined the European Union in 2004. It is concurrently part of the Commonwealth of Nations and the United Nations.

It is an independent Island-State and has had its own self-government since 1964. Malta has a prosperous free market economy; it has adopted the Euro as its national currency, since 2008.

### **Background**

In the EU the Noise Directive, 2002/49/EC, [1] defines a common approach intended to avoid, prevent or reduce the harmful effects of noise on human health, including annoyance and sleep disturbance due to exposure to environmental noise. Noise mapping is one crucial step towards the objectives of the Directive: strategic noise maps had to be established no later than 30 June 2007 in EU member states. More specifically, noise maps are required for all agglomerations with more than 250,000 inhabitants and for all major roads that have more than six million vehicle passages a year anywhere within the EU. To date, (Dec 2013), Malta is one of the few EU member states that have not yet complied with the Directive.

On the other hand, in Malta, in view of its size, the reference benchmark of 250,000 inhabitants for any agglomeration is not applicable (deemed to be equivalent to a major town or city in the EU). However in 2005, Malta informed the Commission that its capital city, Valletta and its urban conurbation does encompass a population amounting to this benchmark; in fact it exceeds the 250,000 mark. Therefore, although



seemingly voluntarily, Malta had actually committed itself to establish such noise maps covering this area, as part of an overall National Action Plan.

## 16.2. Design and Acoustic Performance in MALTA

Setting the record straight from the start, to date Malta has no code of practice or legislation that specifically dictates the use of sound insulation in buildings. This is probably because the heavy monolithic masonry walls provide sufficient mass towards reducing noise between third party walls. Today stringent sound reduction requirements are being introduced for isolating leisure or semi-industrial facilities from residential units. This is primarily done by zoning but still specific dB levels apply for certain working trades, including hours of work operations and business hours for entertainment localities.

Today's basic architecture for housing (private or social) consists mainly of good-sized open terraces, either with a setback from the main façade or simply a projection onto the street, exploiting the summer breeze. Treatment of openings is modest with a general mix of concrete and stone. All walls are load-bearing with no frame structure necessary. Hence there is no option to install infill panels that have dedicated thermal or sound insulation. The solid mass of the wall does it all – structure, thermal and sound isolation. (Hence the missing legislation).

### 16.2.1. Overview of Housing Stock



**Figure 16.1.** *Mix of four and two storey houses in Qormi, Malta.*

Malta has no high-rise residential blocks when compared to European States. Typically housing blocks are never in excess of four floors and these were even designed to be part of a mixed development scheme



layout, comprising units of two-storey terraced houses, maisonettes and flats. The early sixties saw the beginning of such layouts in Santa Lucia, San Gwann and Qormi among others. Figure 16.1 depicts such a typical streetscape mix in Qormi, a central town, the third most densely populated in Malta. All these experienced rapid growth in population. Valletta, the Capital, is however a totally different story.



**Figure 16.2.** Valletta, the historic Capital.

Valletta is a Baroque architectural gem, built after the Great Siege of 1565, by Grand Master Jean de La Vallette, hence its name. Lying on a natural peninsula, it is cordoned with tiers of fortifications, dating back to the 16th century. Although listed as a UNESCO world heritage site, it is today a living modern city bustling with commercial activity. However most residents have moved out, in preference of sub-urban homes, or living on the satellite, equally old town of Floriana. It is evident from an earlier 2005 Census that the number of vacant households in the city is unusually high, Table 16.1 refers. This is also the result of population loss which, in Valletta declined from over 22,000 in 1939 to around 7,000 today. This exodus fuelled urban sprawl in the rest of the islands and between 1956 and 1997 the percentage of built-up area increased from 4% to 22%. Today's built up area extends over 27% of the Malta's territory.

**Table 16.1.** Housing stock distribution in Valletta.

Indicator	Valletta
Educational Attainment	Out of a total of 1,346 registrations for secondary level certification in the Southern Harbour district only 4% were from Valletta.
Total housing stock	2,594 households
Single person household	35%
Households inhabited by persons over 60	54%
Two person household	26%
Total vacant dwellings (2005)	1,238
Space per inhabitant	0.0001 km <sup>2</sup>
Total population (2011)	5,784
Peak population (and year)	23,006 (1911)
% change in population (2005-2010)	8%
% of people under 15 years of age	12%
% of people over 65 years of age	25%
% Immigrant population	2%
% manufacturing employment	None

Source : National Office of Statistics, Malta.

### 16.2.2. Population Density and Dwellings distribution

It is an established fact that Malta was and still remains by far the most densely populated EU country. It has an average of 1,320 persons per square kilometre, compared to an overall average of 116.6 persons per square kilometre for the EU. The second most densely populated country within the EU is the Netherlands, with 492.2 persons per square kilometre. This is distinctly much lower than Malta, as shown in Figure 16.3, depicting all 27 countries (NOS, Malta, Census Report, 2012) [2].

Given its two natural harbours around the Valletta promontory, most of the activity was always located around this area. Hence most of the working population resides around the Grand Harbour area. The same applies to Gozo, the sister Island. However lately, with the onset of

improved transport routes and technological development, most of the ever-soaring population is spread across the north and south parts of the Islands. Figures 16.4-16.5 depict such population and dwellings' distribution.

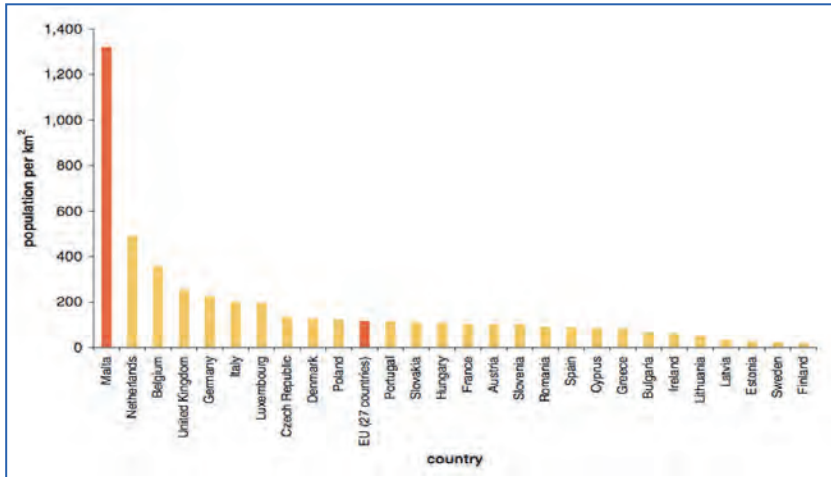


Figure 16.3. Population density across EU member states (NOS, 2012).

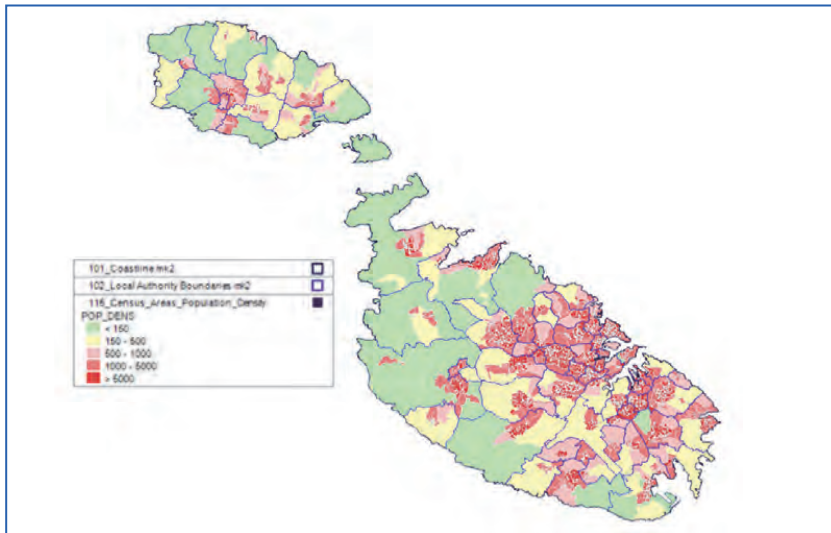
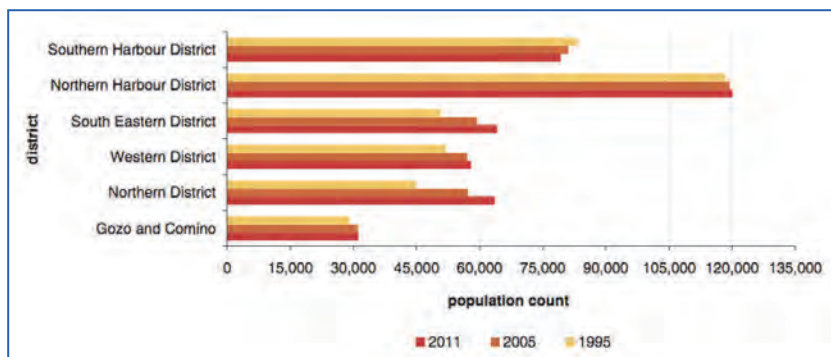


Figure 16.4. Population density for Malta (inhabitants/sq.km) (NOS, 2012).



**Figure 16.5.** Dwellings distribution by district: 1995, 2005, 2011. (NOS, 2012).

### 16.2.3. Proportion of apartments, terraced (row) and detached houses

At the time of concluding this paper, the exact number of households was not yet available. However based on values for the last population census carried out in 2011, when the value stood at 155,202 units, an estimated increase of 7-8% p.a. is envisaged. Therefore a calculated updated value up to December 2013 this number would stand at around 166,842 households, circa 170,000 dwelling units.

The proportions of apartments, terraced (row) and detached houses are shown in Table 16.2.

**Table 16.2.** Housing stock of privately owned dwellings by type.

Type of Dwelling	Number	% of total
Terraced House	66,017	42.54
Semi-detached	7,921	5.10
Fully-detached	3,649	2.35
Ground Floor Tenement	17,658	11.38
Maisonette	20,225	13.03
Apartment/Flat	35,782	23.05
Other	3,950	2.55
<b>Total</b>	<b>155,202</b>	<b>100.00</b>

**Table 16.3.** *Dwellings Stock by Occupancy Status.*

Locality	Total	Occupied	% of total	Vacant	% of total
Maltese Islands	155,202	119,479	76.98	35,723	23.02
Malta	139,754	110,104	78.78	29,650	21.22
Gozo and Comino	15,448	9,375	60.69	6,073	39.31

From Table 16.3, what is most striking and unusual is the number of vacant dwellings, standing at 36% in 2011. According to the latest report, published by the NSO in 2011, specifically on the subject of vacant property, this figure shot up from 53,136 in 2005 to a staggering 72,150 in 2011 [2]. According to local sources from the building industry, this was attributed to two facts: the extension of development zones and the increase of height limitations in 2006 (from two to four floors). These have not only contributed to a massive increase in vacant properties, but also saw a great shift of households (families) from terraced houses to flats or larger apartments.

The relevance of all this is that this shift brought with it new problems of noise and vibration transmission between flats – literally unheard of. Since before any two floors were owned by the same household, no complaints were raised (at least outside the doorstep). Today, in the absence of any formal legislation, numerous court cases have been instituted in favour of the civil right of ‘peaceful possession of property’.

### 16.3. New build Housing Construction

Typical building development in Malta has been undergoing continuous evolution over the past two decades. We have noticed an evident shift from building new plots to demolish “old” houses (albeit relatively new, 20 year-old) to build apartment blocks. This phenomenon has taken us by storm, leaving behind it a trail of vacant properties as reported earlier.

In terms of noise nuisance and dust pollution, owners of terraced houses in established streets are now seeing tower cranes and heavy construction vehicles coming right outside their doorstep. This is also a relatively new noise nuisance since before all new plots of land were built more or less in the same short span, in less time, in rural areas. Today we are witnessing the demolition of the old terraced house, excavation works to create a new basement and the erection of four floors plus basement (instead of





two). All this brings with it a longer duration of the whole construction process. This is perhaps the greatest nation-wide noise nuisance persistent all over the Island at the moment.

On another note, the present evident increase in apartment blocks and the decline in terraced housing (Figure 16.6) has also brought with it a shift in building materials, from the monolithic solid soft stone masonry blocks to hollow-core blocks (HCBs) and roofing systems. This has automatically created a revolution of building materials being used in construction tagged with a sudden change in performance of material properties, including thermal and sound insulation. Basic human requirements of peace and privacy at home have however remained consistent and unchanged.



**Figure 16.6.** Terraced houses (1990) replaced by 'modern' Apartments (2010).

As a consequence to the above, concrete based structures are considered to be on the increase, while the formerly more typical fair-faced Globigerina limestone terraced houses, are becoming a less frequent option for newly constructed houses.

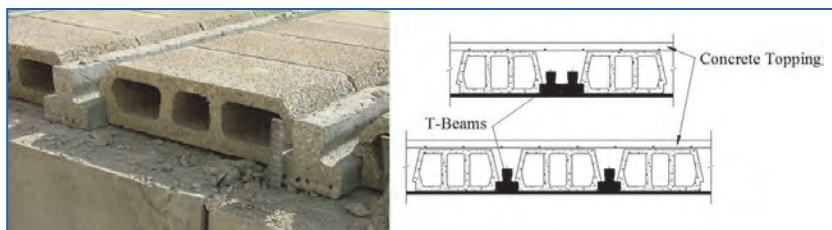
### 16.3.1. Typical performance

Globigerina limestone, a sedimentary indigenous rock, offers a fair Transmission Loss value over a frequency spectrum, due to its mass per unit area of approximately  $280 \text{ kg/m}^2$ , for a single leaf wall (approx. 230 mm thickness).

Even though properties of concrete are known to have good transmission loss properties, in comparison to the former globigerina limestone, there



is more room for noise performance variation. Concrete structures might not perform as desired for various reasons, such as that of poor workmanship, especially with uneven joints between the concrete hollow core blocks (HCB). Apart from the possibility of poor workmanship, which occurs more often than one might desire, errors in design are also encountered. One example may be observed from construction design changes, such as that of flooring. The previously typical continuous flooring slabs, are now at times being replaced with other alternatives such as T-beam and block flooring (Figure 16.7), which is creating possibility of more sound transmission between floors, due to the unevenness of the building elements and the presence of gaps (Cassar, 2010) [3].



**Figure 16.7.** T-beam and block flooring (Ballut Blocks, 2014) [4].

### 16.3.2. Airborne and Vibration induced Noise

Apart from building element design, planning issues, such as the lack of a buffer between one room and another, especially noise-sensitive rooms, is a common design issue. With regards to noise-sensitive rooms, single leaf walls instead of double leaf walls used when designing apartments and flats, definitely create issues with neighbouring apartments, as is the use of lightweight partitions instead of construction walls.

This is also the case for impact sound between floors due to the apartment block design, where the need of a possible floating floor may be overlooked. The increase in apartment block construction and design has created room for increased noise issues and complaints. Propagation issues are an issue both horizontally and vertically. As already mentioned horizontal propagation issues arise due to the type of wall constructions and materials selected.

Vertically speaking, these may be experienced through the continuous load bearing columns travelling through floors, which allow for vibration

propagation, leading to building element vibration and finally noise within rooms. Architects/Engineers in Malta are not accustomed to designing for vibration dampening measures between building elements, to account for both horizontally, and vertically, induced vibration propagation.

### **16.3.3. Acoustical impact on neighbourhood**

In residential neighbourhoods a distinction is often made between external noise (such as highways, railways and industrial zones), as opposed to internal noise generated within the neighbourhood. The former is regulated by the EU Environmental Noise Directive 2002/49/EC which includes the curtailment of such neighbourhood noise levels.

More of a nuisance is perhaps noise generated between apartments (top down or sideways), especially with today's high-powered full surround music systems. In Malta this is only governed by Police Laws with time restrictions only (no max dB levels stipulated).

## **16.4. EU Funding Opportunities and Acoustic Performance**

Practically in all countries national regulations are in place to control noise levels, particularly during a certain time of the day and in certain locations. Exceptions to date include Malta and Cyprus. At present the EU provides no funding opportunities specifically for noise deterring measures. Conversely, to be fair, very often when one is introducing double-glazing or insulation as a thermal measure (EU-subsidised), the sound quality of the space also improves significantly. However sound insulation standards need to be addressed directly through EU legislation.

## **16.5. Conclusions**

In Malta there are no noise limits/regulations to which architects, structural engineers abide by when designing dwellings or modifying a new indoor space, be it commercial or residential. This creates a situation whereby noise is not being tackled at the design stage; hence clients/developers only involve an acoustic expert at a late stage, when a noise issue is identified after construction. Typically, an acoustician or noise engineer would then refer to the WHO guidelines as to what noise may be considered as acceptable, or not, but alas, in Malta this is still post-construction. With the onset of new EU standards for acoustic quality levels in dwellings, as vehemently being put forward through COST Action TU0901 an acoustic classification scheme has been proposed, where all

countries could choose their own class of regulations. Once this goes through the Commission, and transposed into local legislation at Member State level, then all the above highlighted problems should then be only an echo of the past.

## 16.6. References

- 1 Environmental Noise Directive, (END): 2002/49/EC: <http://eurlex.europa.eu/LexUriServ/LexUriServ.do?uri=OJ:L:2002:189:0012:0025:EN>
- 2 NOS, (National Office of Statistics), Malta, Population Census Report, 2012 : <http://www.nso.gov.mt>
- 3 N. Cassar (2010): An Investigation of Noise Control Parameters and Measurement Techniques, University of Malta Dissertation, pp54.
- 4 [http://www.ballutblocks.com/t-beam\\_and\\_block\\_flooring.html](http://www.ballutblocks.com/t-beam_and_block_flooring.html)



# Building acoustics throughout Europe

## Volume 2: Housing and construction types country by country

# 17

## Netherlands

Author:  
**Wim Beentjes**

LBP SIGHT BV PO Box 1475, Nieuwegein, Netherlands  
e-mail: [w.beentjes@lbpsight.nl](mailto:w.beentjes@lbpsight.nl)



## CHAPTER

## 17

## Netherlands

## 17.1. Design and acoustic performance

### 17.1.1. Overview of housing stock

The quantities of housing stock, the total population and the proportion of apartments, terraced (row) and detached houses are given in Table 17.1.

*Table 17.1. Housing stock , number of inhabitants in 2010 in the Netherlands.*

Number of inhabitants	16.730.632	percentage
Total housing stock	7.000.000	100
Apartments and maisonettes	2.300.000	33
Terraced houses	3.700.000	53
Detached houses	1.000.000	14
Area of the Netherlands km <sup>2</sup>	41.526	
Number of inhabitants pro km <sup>2</sup>	403	

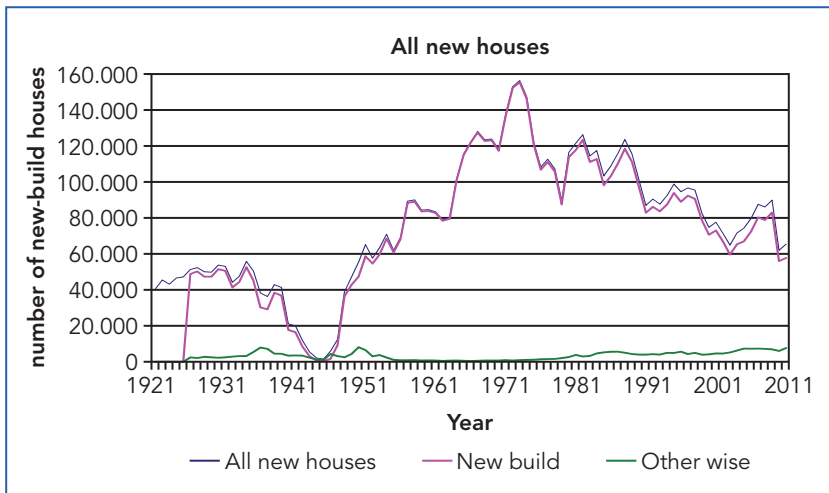
The most populated cities of the Netherlands are:

Amsterdam 720.000; Rotterdam 590.000; Den Haag 440.000; Utrecht 235.000; Eindhoven 220.000.

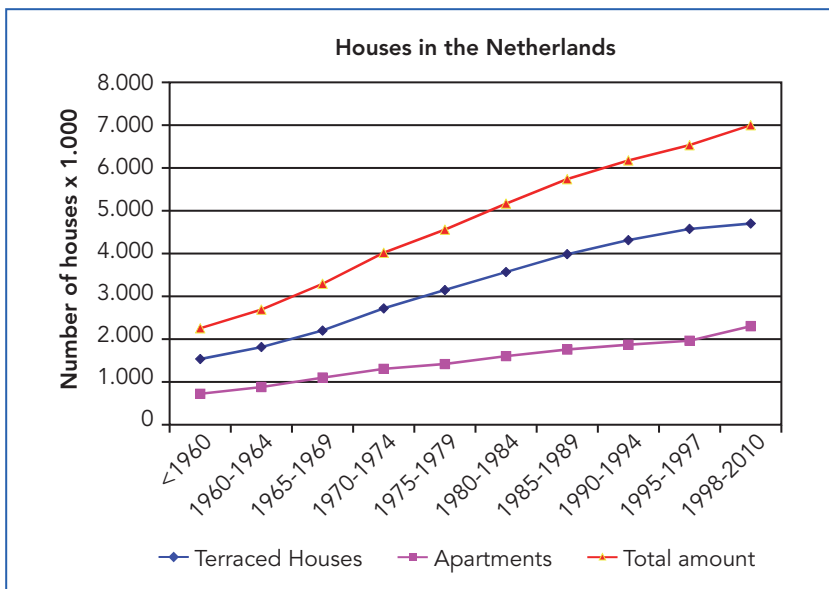
The increase of new dwellings during the last 90 years is given in Figure 17.1.

The top years for building houses are the early seventies. In the years during the 2<sup>nd</sup> world war it was not possible to build new houses. The crisis of 2008 causes the lower numbers of the last years.

The distribution of terraced houses (including detached houses) and apartments is given in Figure 17.2.



**Figure 17.1.** Number of new houses from 1920 till now: newly built and other wise (transformation for example).  
Source: Dutch Central bureau of statistics.



**Figure 17.2.** Number of houses from 1960-2010 in terraced houses (including detached houses) and apartments.

Some typical Dutch dwellings of the last century are shown in the next photographs.



(Left) Porch houses (1930) and (Right), typical semi-detached houses (1933).



1960: (Left) Porch Houses (Right) Gallery houses typical for the period 1965-1975.



(Left) Porch houses built in the 50's and renovated in the 80's because of sound insulation of the façade and (Right) Porch houses also built in the 60's, renovated in 2010, with as main topic thermal insulation.





*Terraced houses and apartments in the 80's.*



*Modern apartment buildings of the late 90's and early 21th century(2005).*



*Colorful terraced houses of 2006 (left). (Right) a recently built example of passive houses.*



### 17.1.2. Newly built housing constructions

The requirements for newly built houses over the last 50 years are given in table 17.2. See for the history of this requirements (Beentjes,2011).

**Table 17.2.** Requirements airborne and impact sound insulation during the last 50 years.

Period	Airborne	Impact	Reference document
1962 – 1976	$R'_w + C \geq 51 \text{ dB}$	$L'_{nW} \leq 65 \text{ dB}$	NEN 1070:1962
1976 – 1992	$D_{nTw} + C \geq 51 \text{ dB}$	$L_{nTA} \geq 59 \text{ dB}$	NEN 1070:1976 BGG 1983[14]
1992 – 2003	$D_{nTA;k} \approx R'_w + C \geq 52 \text{ dB}$	$L_{nTA} \leq 59 \text{ dB}$	Building decree 1992
2003 – now	$D_{nTA;k} \approx R'_w + C \geq 52 \text{ dB}$	$L_{nTA} \leq 54 \text{ dB}$	Building decree 2003 and 2012

For facade sound insulation the requirements are:

$D_{2m,nTA} - 10 \log V/3S = L_{DEN} - 30 \text{ dB}$  with a minimum of 23 dB.  $V$  = the volume of the room and  $S$  the total surface of the façade. This formula is due since 1992, between 1983 and 1992 the formula was without the  $10 \log(V/3S)$  term.

For service equipment the requirements are  $L_{IAk} = L_{IA} + 5 \log(V/25) \leq 30 \text{ dB}$  for sources from outside the dwelling and for inside sources only ventilation systems and or heating and warm water systems.

For the construction of newly built houses a Dutch Code of Practise (NPR 5070:2005) for stony and concrete constructions is available. This code of practice gives solutions to meet the Dutch requirements of the Building Decree of 2003 and 2012 and to meet a 5 dB better classification than the requirements. In the Dutch classification scheme for sound insulation NEN 1070:1999, the legal requirements are in class 3, the 5 dB better values in class. 2. The reference details in NPR 5070:2005 are also worked out in the "SBR reference details " and the SBR comfort details" published by the Dutch Building Research Foundation(SBR 1992-2013).

#### 17.1.2.1. Terraced housing

##### 17.1.2.1.1. Heavy typical constructions

The following types of cavity walls (ca 40 % of the newly built terraced houses) are used:

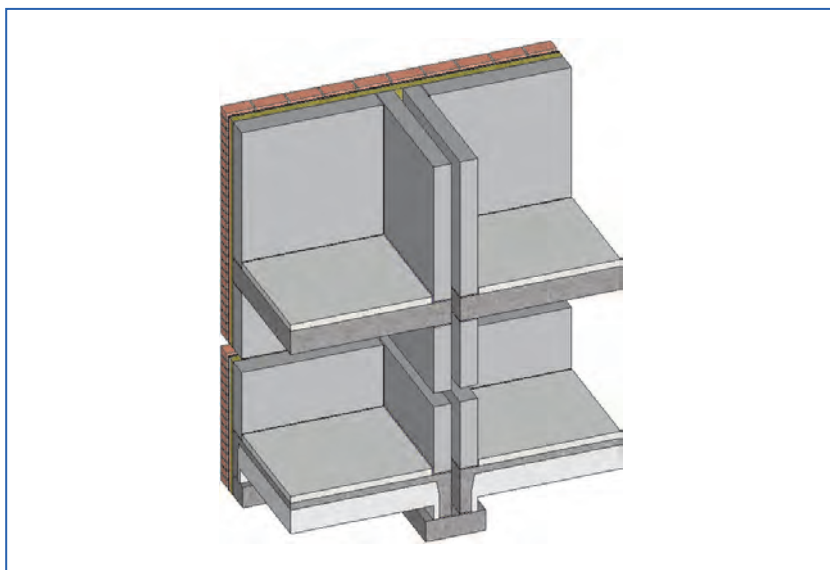


1. 120 or 150 mm limestone, cavity 60 or 50 mm or 'light' precast concrete (both with a mass of  $1750 \text{ kg/m}^3$ ) ( $210 \text{ kg/m}^2$  or  $265 \text{ kg/m}^2$  for each cavity leaf).
2. 90 or 100 mm precast concrete ( $\approx 2400 \text{ kg/m}^3$ ) with a cavity of 40 mm, ( $215$  or  $240 \text{ kg/m}^2$  for each cavity leaf);
3. 120 or 140 mm concrete ( $2300 \text{ kg/m}^3$ ) with a cavity of 60 or 80 mm (made at location) ( $276$  or  $322 \text{ kg/m}^2$  for each cavity leaf);

Figure 17.3 gives a typical layout for a cavity wall with the connection with the façade, the ground and first floor.

The *solid walls* form ca 60 % of the terraced houses and the following constructions are used:

1. 300 mm limestone ( $1750 \text{ kg/m}^3$  or  $525 \text{ kg/m}^2$ ) or 250 mm heavy limestone ( $2200$  or  $2300 \text{ kg/m}^3$  or  $575 \text{ kg/m}^2$ )
2. 230 mm or mostly 250 mm of concrete ( $2300 \text{ kg/m}^3$ ) or 220 mm precast concrete ( $\approx 2400 \text{ kg/m}^3$ ) with a mass of 529 , 575 respectively  $525 \text{ kg/m}^2$ .



**Figure 17.3.** Ground floor, and first floor details of a Dutch cavity wall in terraced houses since 1975. Since 1992 mostly with an acoustical layer between foundation and ground floor.



In figure 17.10 an example is given for solid constructions for apartment buildings. Changing the floor into a floor with a mass of ca 400 to 550 kg/m<sup>2</sup> (170 to 200 mm+ 50 mm screed) results in the detail most used for terraced houses with solid separating walls. The detail for the ground floor is given in figure 17.4.

The most common *flanking constructions* are:

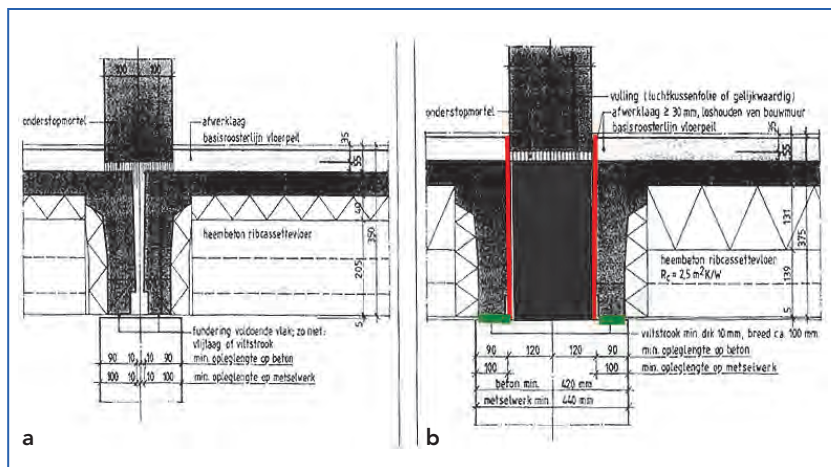
Ground floor: Ribcassette (+ 50 mm screed with a mass of ca 320 kg/m<sup>2</sup>).

Or hollow core slab floor with 50 mm screed (> 350 kg/m<sup>2</sup>).

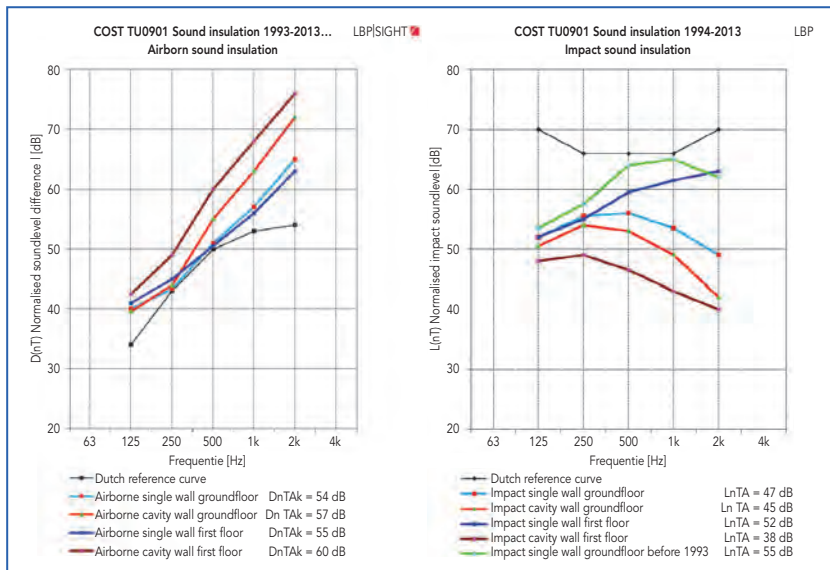
Inner façade: 100 mm limestone or 90 mm precast concrete (flex) or 150 mm limestone (rigid) or TB only in combination with concrete partition wall.

Outer façade: Mostly 100 mm brick or plastered EPS (mostly mineral wool in the cavity).

The average results of constructions for cavity and solid walls are given in figure 17.5a for airborne and 17.5b for impact sound insulation for cavity walls and single walls.



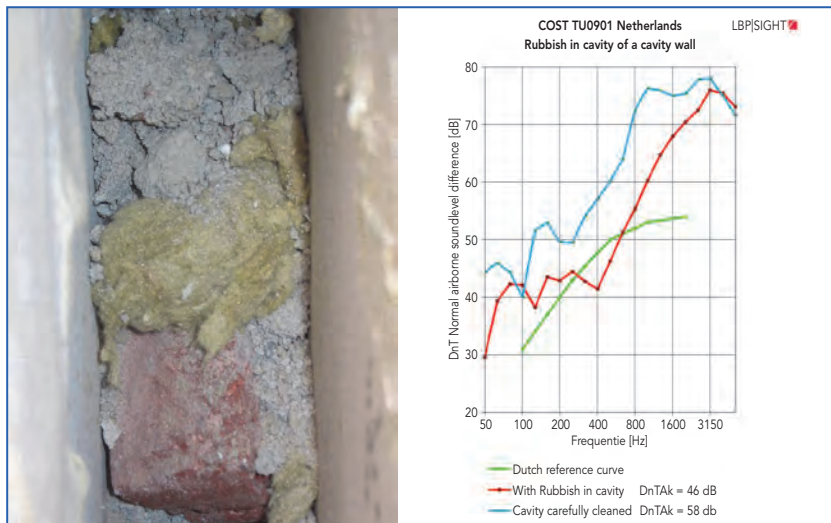
**Figure 17.4.** The junction between the solid separating wall, ground floor, foundation: **a.** The rigid junction before 1994 (the ground floor is placed between the separating wall and the foundation); **b.** The flexible junction after 1994 with ground floor next to the solid wall separated by 15 mm EPS (red lines) and a flexible layer of 10 mm rubber or fur felt (green lines) and a 200 mm broader foundation, See Hartman et.al. 1998).



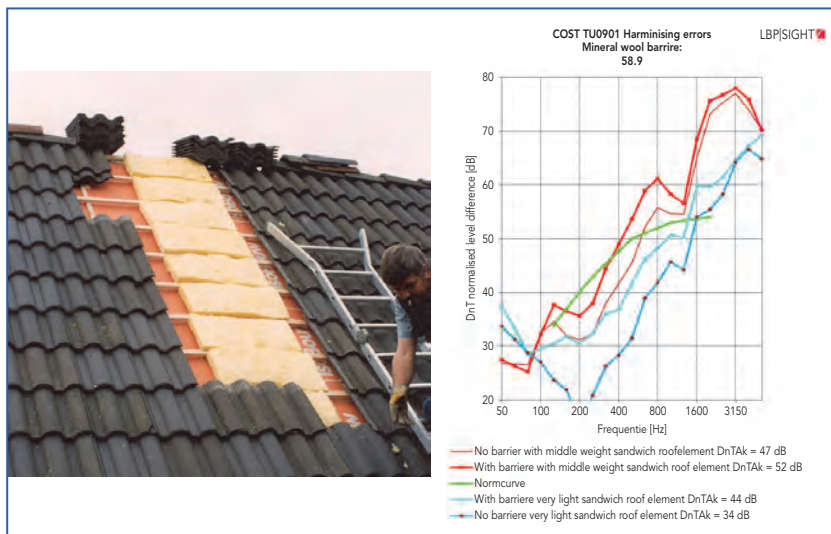
**Figure 17.5.** Average sound insulation in horizontal direction of newly built terraced houses with solid and cavity walls: airborne (left) and impact (right) for the ground floor and the first floor. (Green line: ground floor with old detail (<1994).

Typical errors in design and workmanship for heavy constructions:

1. Too low a mass for the inner façade wall in combination with a rigid junction and 300 mm limestone. (100 mm limestone must have a flexible junction. For a rigid junction, at least a 150 mm limestone inner façade >250 kg/m<sup>2</sup> is needed);
2. Ground floor under the solid wall instead of next to the wall on a broadened foundation. See in figure 17.5b the difference of 8 dB in LnTA between the old detail (green line) and the new detail (blue line). The details are shown in figure 17.4a and b.
3. Rubbish and/or screed in the cavity of a cavity wall. See figure 17.6.
4. Leakages or no good filling of the adjust space between parts of separating walls (dilatation)
5. (very) Lightweight sandwich roof elements and/or no mineral wool barrier between roof elements and upper part of the separating wall especially with roof elements with 'hard' insulation as EPS, PUR and PIR. See figure 17.7.



**Figure 17.6.** Rubbish such as screed and pieces of brick in the cavity. The airborne sound insulation before (red) and after careful cleaning of the cavity (blue).



**Figure 17.7.** In case of lightweight sandwich roof elements and single leaf elements with EPS, PUR or PIR as thermal insulation, a mineral wool barrier is needed on the upper side of the separating wall (left). The better the roof element the smaller the effect of this barrier. See also (Lichtveld 1979).

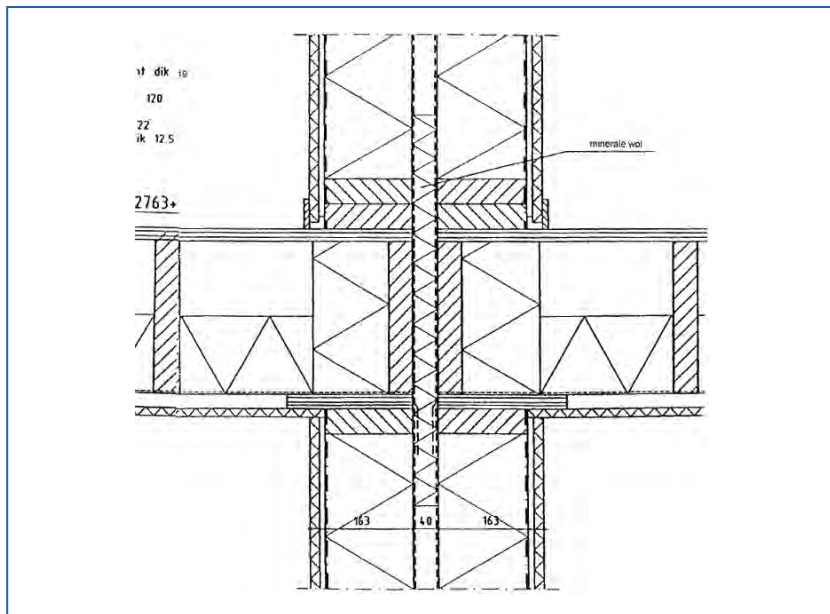


Special features of heavy constructions:

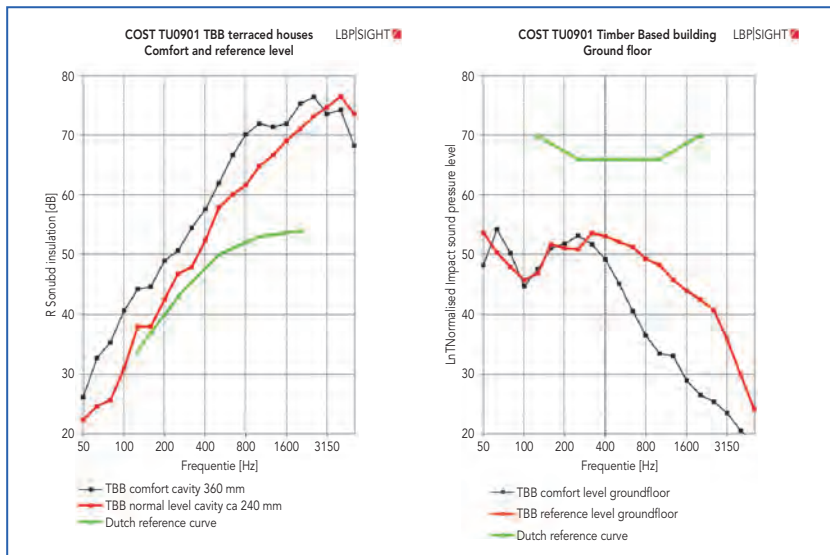
1. With cavity walls: foundation , flexible layer with a max load of 2 to 5 N/mm<sup>2</sup> , the ground floor and upon this floor one side of the cavity wall. See also the results in figure 17.5 a and b.
2. First and second floor massive concrete (550 to 600 kg/m<sup>2</sup>) or hollow core slab precast concrete floors (400 kg/m<sup>2</sup>)
3. inner facade: 100-150 mm limestone (1750 kg/m<sup>3</sup>) or timber based single leaf element filled with mineral wool (Only in combination with concrete walls).

### 17.1.2.1.2. Lightweight typical constructions

As lightweight constructions only timber based buildings(TBB) are in use in the Netherlands for terraced houses, always as a cavity wall; it is used in ca 5% of the yearly newly built house production stock. The typical construction is given in figure 17.8. Average results for class 3 and class 2 according to NEN 1070:1999 are given in figure 17.9.



**Figure 17.8.** Timber Based building with cavities of 200 to 300 mm: detail of first floor see (SBR 2003).



**Figure 17.9.** Average results of airborne (left) and impact sound insulation (right) for reference and comfort level for ground floor of TBB buildings.

Typical errors in design and workmanship of lightweight construction:

Plywood or OSB on the cavity side of the wooden studs. This results in three relatively small cavities. Mostly done because of fire protection and/or constructive reasons. But it is not necessary. It is much better to place all the plates only on the room-side of the wall (for example 12 mm OSB in combination with 12,5 plasterboard) and create a large cavity of 250 à 300 mm, instead of three cavities of 80 to 95 mm;

Special features for lightweight construction:

1. The ground floor is always performed as a precast concrete floor of Ribcassette elements, the same as with solid cavity walls. The first and second floor are wooden floors
2. Because of thermal reasons (more thermal capacity of the dwelling) a ca 40 mm layer of anhydrite or screed is used on the first and second floor. This also improves the impact sound insulation inside the dwelling as well as in horizontal direction ( values up to  $L_{nTA} \leq 30$  dB are possible)
3. The standard deviation of measurement results in TBB is higher than in solid construction)



### 17.1.2.2. Apartments/flats

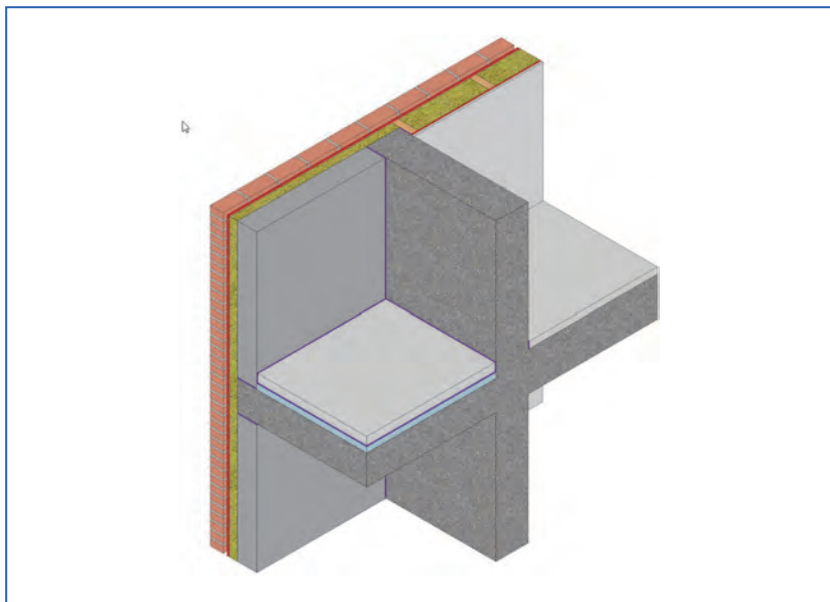
#### 17.1.2.2.1. Heavy typical constructions

New built apartments are built according to the following rules for heavy constructions:

1. Cavity walls are not in use for apartments because the cavity leafs as used in the terraced houses (ca 200 kg/m<sup>2</sup>) give too much flanking transmission in the vertical direction. Because there is always a rigid junction between heavy separating walls and floors, the Dutch code of practise stipulates that the cavity leafs must have a minimum weight of 350 kg/m<sup>2</sup>. In most cases this is no alternative for 250 mm concrete or 300 mm of limestone solid walls.
2. Solid walls are nearly always used, the same walls as in terraced houses.
3. In 2010 ca 60 % of the apartments has solid separating floors. According to the Dutch code of practise (NPR 5070:2005) they have a mass of more than 800 kg/m<sup>2</sup> (280 -300 mm of concrete with 70-50 mm anhydrite or screed). It is necessary that there is a good connection between the concrete base floor and the screed or anhydrite;
4. Nowadays in ca 40 % of the apartments floating floors are in use: 230-280 mm of concrete, a floating layer with a dynamic stiffness of (10-20 MN/m<sup>3</sup>), a waterproof layer (0,2 mm) and 50-70 mm anhydrite or 65-75 mm screed.). Sometimes a floor heating system is built in in the screed.
5. On places where a separating wall is needed and a bearing wall is not necessary, lightweight walls can be used, such as:
  - 210 mm Metal Stud walls (double metal stud and 2 x 12,5 mm gypsum board)
  - 2 layers of 70 mm solid gypsum or aerated concrete, with a cavity of 50-70 mm and a small acoustical lining(37,5 mm),
  - 2 layers of a 54 mm thick storey high elements with a core of flax straw in the middle and with a 9,5 mm thick plasterboard on both sides separated by a cavity of 150 mm filled with.

The Dutch code of practise (NPR 5086:2006) the precautions that have to be made for the typical flanking transmission that occurs in these walls.

The high mass according to point 3, is necessary because of the fact that the Dutch requirements have to be met without any floor coverings. ( $L_{nT,A}$  ≤ 54 dB). See for the way of building figure 17.10



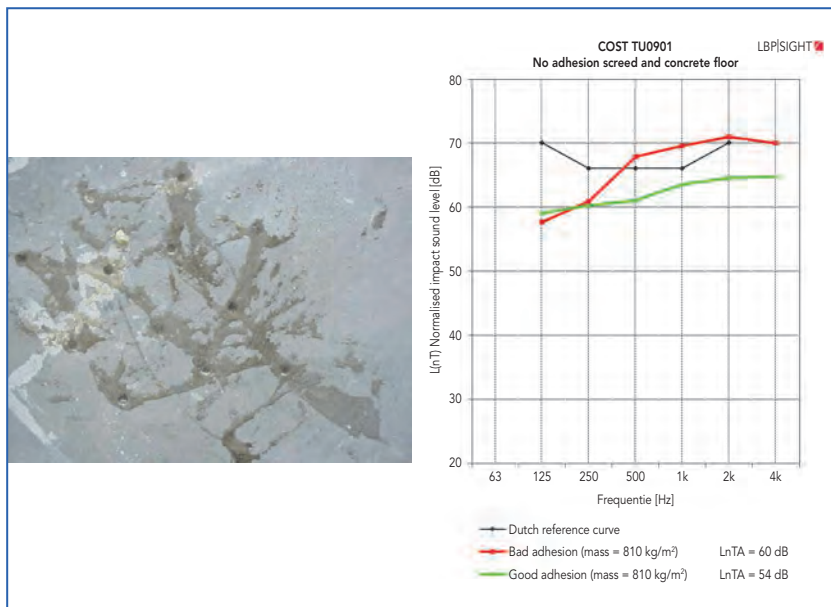
**Figure 17.10.** 3D detail of solid separating wall and (right) a TB inner façade and (left) a solid limestone one. The separating floor is a  $800 \text{ kg/m}^2$  solid floor (right) or a floating floor (left).

Important issues:

1. The floating floor and the vertical constructions are separated with a 5 to 8 mm thick foam layer, or the same material as the floating layer;
2. The floating floor may have no connections with the bearing floor and the vertical constructions that are not placed on the floating floor;
3. For facades and ground floors the same constructions are used in case of terraced houses.
4. If there are a garage and/or shops under the apartments the floor between the garage/shops has nearly always a solid floor of more than  $800 \text{ kg/m}^2$ .

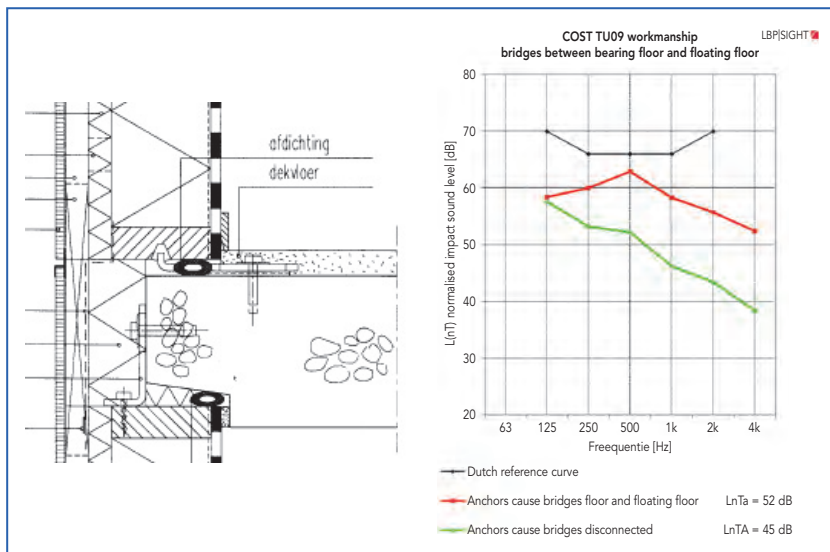
Typical errors in design and workmanship for heavy constructions:

- In solid floors there is no good adhesion between the screed or anhydrite and the solid floor, see figure 17.11
- Too high dynamic stiffness of the floating layer in design and workmanship



**Figure 17.11.** No good adhesion of the screed or anhydrite (red) with the concrete base floor leads to 5 till 7 dB lower  $L_{nT,A}$  values than good adhesion(green). (right) The picture (left) shows the result of the remedy: Injection in holes ( $\varnothing$  5 mm)with two component resin under low pressure.

- In case of for floating floors: connections between the screed/anhydrite with walls and facades and with the concrete base floor. Mostly workmanship errors occur when these two basic rules are violated.
  - by plasterwork on walls and facades.
  - after repairing broken water pipes etc. under the screed, wrong restoration of floating floor afterwards
  - separating walls placed on the floating floor and directly and rigidly connected with the separating wall or facade
  - no good waterproof connection between the foam layer on the perimeter and the waterproof layer
  - connection caused by heat pipes, and/or pipes for water supply or by anchors (see figure 17.12)



**Figure 17.12.** Left: Anchors to fasten TBB inner facades cause connections between base floor and floating floor. The effect causes 7 dB higher  $L_{nTA}$ . (red line before and green line after repair).

A typical error with light weighted separating walls in combination with a floating floor is that there is no dilatation in the floating floor at the cavity of the light weighted wall. The difference in dB before and after repair is mostly more than 17 dB!!

Special features for heavy constructions:

In newly built dwellings sound leaks caused by wholes for central heating pipes or ventilation ducts in separating floors and walls of rooms are not present any more. The ventilation ducts are embedded in the basic floors and the heating pipes are included in the screed or anhydrite layer.

### 17.1.2.2.2. Lightweight typical constructions

In the Netherlands lightweight constructions are in an experimental phase. Several manufacturers are developing lightweight cavity structures using bearing steel and concrete layers of small thickness (70 or 80 mm) (for example La Fenêtre in The Hague). Because of the lower sound insulation in the lower frequencies of these types of constructions, they are often used in schools (except in sports halls and gymnasias) and office buildings.



Some apartment buildings are timber based (maximum amount of floors is 4) but they are in a small minority. See for more information about new developments the E book of COST action FP0702 first part and (Lentzen, 2010). There is also a trend to make it easy to change the destination of a building (e.g. offices into car parking , hospitals into dwellings , etc). Also in this field lightweight constructions are a very good alternative and they play an important rule in it.

### 17.1.3. Existing housing

#### 17.1.3.1. Houses with wooden floors and stony walls, built before 1950

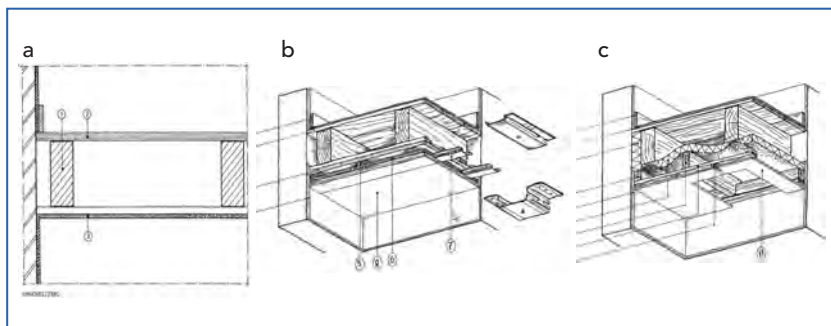
The basic constructions for apartments and terraced houses in this period were built as follows:

Wall: 220 mm brick wall with 15 mm plaster on both sides mass  $\approx 370 \text{ kg/m}^2$ .

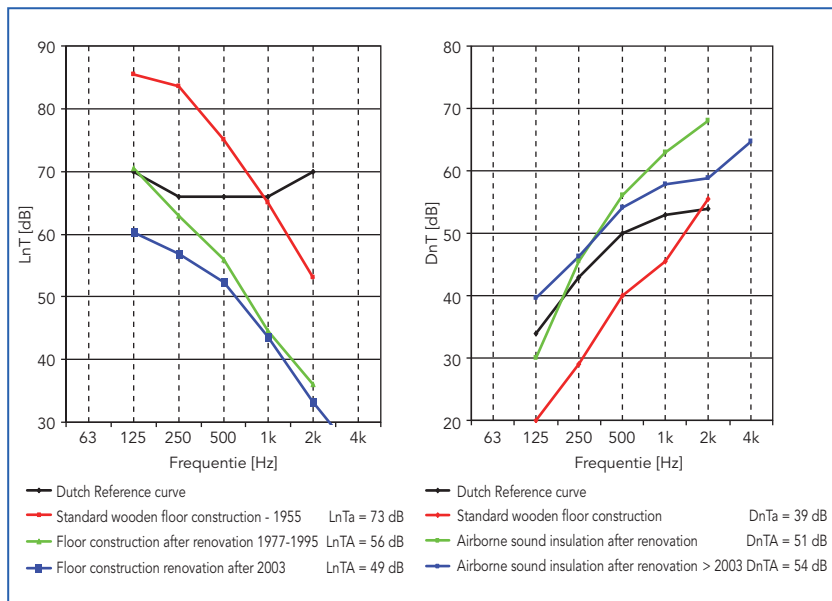
Floor: wooden floors with a 22 mm wooden boards, wooden beams of various sizes and plaster board or so called plaster-on-reed. See figure 17.13a

Facades: till 1930 solid brick walls of 220 mm , after 1930 the cavity wall with anchors came into use to solve the moisture problems of the solid façade.

Inner walls: in nearly all situations a constructive brick wall of 100 mm thick with plaster layers on both sides was used as a bearing wall to carry the wooden floor construction. Other inner walls were made of light weighted blocks with a mass of 600-900  $\text{kg/m}^3$ .



**Figure 17.13.** **a.** The original wooden floor in dwellings and apartments till 1950 and **b.** the renovation between 1975 and 2003 with a flexible extra ceiling. **c.** There is also an alternative with the original ceiling removed (see Hartman 1980).



**Figure 17.14.** Typical results of improvements of the airborne and impact sound insulation of wooden separating floors in apartments: original (red), improvement between 1975 and 2003 (green), after 2003 (blue).

### Renovation of wooden separating floors between 1975 and 2003

Between 1975 and 2003 most of the floors in this types of apartments were renovated with free placed plasterboard, with or without removing the original plasterboard or plaster on reed. On top of the wooden boards an 8 mm chipboard was placed to “seal” the holes in the boards. See figure 17.13b and c for the details and the typical results of such a renovation. The improvements are more ca 16 dB for impact sound and 12 dB for airborne sound. See figure 17.14.

### Renovation of wooden separating floors after 2003

After 2003 an extra measure was needed because the impact sound insulation requirements for newly built houses were increased with 5 dB. This was mostly done by placing a dry floating floor on the wooden floor.

The improvements in the airborne and impact sound insulation are also given in figure 17.14.

### 17.1.3.2. Existing houses built between 1950 and 1975

Between 1950 and 1970 the 100% wooden floors were gradually replaced for 100 % by concrete floors because after the 2<sup>nd</sup> world war there was not enough wood available. The mass increased from 200 kg/m<sup>2</sup> (the first hollow brick floors) in 1950 to 350 kg/m<sup>2</sup> in 1970. Sometimes heavier floors (till 500 kg/m<sup>2</sup>) were used when the distance between the separating walls was about 7 m. The ground floor varied with a mass of 175 to 250 kg/m<sup>2</sup> and the first floors 250 to 500 kg/m<sup>2</sup>.as well for terraced houses as for apartments. Facades were made of bricks just as before 1950 but gradually more and more prefab wooden elements, complete with windows etc were used. Acoustically there were problems with air tightness of the junction between the façade element and the separating wall and floor. Also the anchors for fastening on the wall and plates covering the wall caused very rigid couplings between the façade elements and gave extra flanking sound transmission.

### 17.1.3.3. Existing houses built between 1976-1992

After 1976 as a result of new investigations (see Gerretsen,1979) the first edition of NPR 5070:1977 was produced, a handbook especially made for the building industry and contractors to show how to meet the requirements. As a consequence of the research the mass of the separating walls became 460 to 525 kg/m<sup>2</sup> and the mass of the separating floor increased to 400 - 500 kg/m<sup>2</sup>. Also the separating wall became thicker: from 160 or 180 mm to 200 or 230 mm of concrete. In this period the coreless cavity wall was introduced, see Louws,2010.

### 17.1.3.4. Existing houses built between 1992-2003

The new building decree 1992 changed the mass of separating floors from 400-500 to 600 kg/m<sup>2</sup> because of more severe requirements for airborne sound insulation and in 2003 ( $R_A \geq 52$  dB). The second version of NPR 5070:1993 was produced. In 2003 the new Building Decree 2003 stipulated 5 dB more severe requirements for the impact sound insulation. For massive floors the minimum value of the mass became 800 kg/m<sup>2</sup> ( $L_{nT,A} \leq 54$  dB) see also 17.1.4. This also lead to the third edition of NPR 5070:2005

### 17.1.3.5. Renovation of houses built after 1950

After ca 25 years

For dwellings built after 1950 the social rental dwellings in particular are improved after 25 years, because they are in need of major maintenance. The improvements carried out are:

- New kitchen, toilets and bathrooms (with a shower and so on)
- Improvement of the thermal insulation of the glazing and sometimes also the light parts of the façade. If there were problems with air leakages and coupling of façade elements with one anchor on the separating walls and floors, these problems were solved because nowadays it is known how to make a good flexible junction between the separating wall/ floor and façade elements. The sound insulation of roof elements can be improved by placing a mineral wool barrier above the separating wall; see also figure 17.7.
- When a dwelling is alongside a road with too much traffic noise, the sound insulation of the façade can be improved to a 5 dB lower value as for newly built dwellings. A special subsidy from the ministry of housing made this possible (sound level in living and bedrooms 38 dB instead of 33 dB for newly built).
- During this major maintenance no money was left for improving the sound insulation of separating floors and walls. Sometimes the inhabitants were annoyed by the noise of the road, and after the improvement of the façade, they experienced problems with the noise of their neighbours.

#### *After more than 40 years*

A more substantial renovation is possible when dwellings are more than 40 years old. In most cases an investigation of the acoustical quality takes place. Improvements on sound isolation may be carried out, depending on the difference with the current requirements, the costs and the implications for the building. Air leakages around central heating pipes for example will always be repaired with elastic kit etc.

Up to 2012 the legal requirements for newly built houses had to be reached. Only when it was technically or financially difficult to perform, the local government could give a dispensation of maximum 10 dB. In 2012 this has changed. Now the legally obtained level is the basic principle. Built in year x, you have to reach the level of year x. In practise the highest possible level is the level to be reached, because people of today want the sound insulation level of today, which is in most cases higher than the legally obtained level.





### *Methods of improving sound insulation in houses built after 1950 with stony or concrete floors*

The sound insulation of separating walls can be improved by using free standing acoustical linings. In most cases the sound insulation is ca 4 to 0 dB lower than the newly built requirements. In many cases the lower values were caused by plaster that is no longer glued to the brick wall. In most cases the newly built requirements can be reached, but in many cases the housing associations decide not to change the separating walls because of the little effect of 2 or 3 dB.

The floors in apartments have to be improved to reach the requirements for newly built houses because the values vary from  $L_{nT,A} \leq 67$  dB to  $L_{nT,A} \leq 59$  dB. By using acoustical linings under the floors and dry or wet floating floors the sound insulation can be improved.

Because the facades of dwellings built between 1950 and 1992 had a very insufficient thermal isolation, the thermal isolation had to be improved. The lightweight facades were replaced by new façade elements with a good airtight junction between the façade and the separating wall/floor. Also flexible junctions were made by material that covers the wall between the façade elements and is connected flexibly with these elements. Also anchors connect only one façade element to the floor or wall.

The stony floors built in the 50's and 60's mostly have a mass between 200 and 350 kg/m<sup>2</sup>. In most cases a dry floating floor and/or an acoustical lining under the ceiling are used to improve the vertical sound insulation. Table 17.3 gives an example of a matrix to choose the measures to improve the sound insulation in case of renovation of old apartments to reach the level of newly built houses.(see Gypbox, 2005)

In the SBR 1992-2013-Renovation details, several examples are given to improve the sound insulation quality and the quality of other disciplines of building physics,

#### **17.1.4. The quality of sound insulation in the last 40 years**

Over time the changes in building guidance and constructions have led to improvements in the sound insulation quality. Several studies from 1970 till 2007 have been undertaken. This paragraph summarises the main findings. All results are recalculated to the present sound insulation single numbers:  $R_A$  or in terms of NEN EN ISO 717 part 1 ( $R_w + C$ ) and  $L_{nT,A}$  for impact sound insulation. ( $L_{nTw} + C$ ). (The old Dutch descriptor for impact



**Table 17.3.** Table to improve sound insulation with acoustical linings, for walls and ceilings and floating floors in case of renovation of apartments.

Design table Renovation for apartments $D_{nTAK} (R_A) \geq 52\text{dB}$ and $L_{nTA} \leq 54\text{dB}$				
Type of wall $\Rightarrow$		Solid $\leq 500 \text{ kg/m}^2$	Solid $\geq 500 \text{ kg/m}^2$	Solid $\geq 600 \text{ kg/m}^2$
$\Downarrow$ Type of floor				
Wooden floor	Floating floor	$\Delta L_{in} \geq 13 \text{ dB}$	$\Delta L_{in} \geq 13 \text{ dB}$	$\Delta L_{in} \geq 13 \text{ dB}$
	Acoustical Linings	MS 70V/45.2.A.10	-	-
	Ceiling	MS 75P/50 2.A.10	MS 75P/50 2.A.10	MS 75P/50 2.A.10
Stony Floor				
$\geq 250 \text{ kg/m}^2$	Floating floor	$\Delta L_{in} \geq 10 \text{ dB}$	$\Delta L_{in} \geq 10 \text{ dB}$	$\Delta L_{in} \geq 10 \text{ dB}$
	Acoustical Linings	MS 70V/45 2.A-	-	-
	Ceiling	MS 63P/50 1.A.160	MS 63P/50 1.A.160	MS 63P/50 1.A.160
$\geq 350 \text{ kg/m}^2$	Floating floor	$\Delta L_{in} \geq 10 \text{ dB}$	$\Delta L_{in} \geq 10 \text{ dB}$	$\Delta L_{in} \geq 10 \text{ dB}$
	Acoustical Linings	MS 70V/45.2.A.10	-	-
	Ceiling	MS 63P/50 1.A.10	MS 63P/50 1.A.10	MS 63P/50 1.A.10
$\geq 400 \text{ kg/m}^2$	Floating floor	$\Delta L_{in} \geq 13 \text{ dB}$	$\Delta L_{in} \geq 13 \text{ dB}$	$\Delta L_{in} \geq 13 \text{ dB}$
	Acoustical Linings	MS 70V/45.2.A.10	-	-
	Ceiling	-	-	-
$\geq 500 \text{ kg/m}^2$	Floating floor	$\Delta L_{in} \geq 10 \text{ dB}$	$\Delta L_{in} \geq 10 \text{ dB}$	$\Delta L_{in} \geq 10 \text{ dB}$
	Acoustical Linings	MS 70V/45.2.A.10	-	-
	Ceiling	-	-	-

sound insulation  $I_{co}$  is related to the  $L_{nT,A}$  by the equation  $L_{nT,A} \approx 59 - I_{co}$  (dB). Also the level of the requirements are mentioned in the figures. The results are presented in the form of cumulative distributions, so the percentage of cases that meet the requirements, can directly be determined from the figures. Results are shown for airborne (figure 17.15-17.18) and impact sound insulation (figure 17.19-17.21), the vertical (figure 17.17-17.18 and 17.20-17.21) and horizontal direction (figure 17.15-17.16 and 17.19) and for bedrooms and living rooms.

The studies were conducted by Van Rooijen 1975, Van Luxemburg, 1984, Beentjes, 1992, Van Schie et al 2005, Van den Engel e.a. 2006 and Kuindersma et. al, 2007.

In the Netherlands the requirements for impact sound insulation have to be tested *without any floor coverings*. So the improvements by various types of floor coverings (such as carpets and hard coverings on a floating layer) are not taken into account when a floor is tested. In the case of regulations involving groups of owners of apartments it is stated that in the case of hard floor coverings, such as vinyl, parquet, laminate, ceramic or marble tiles etc. a 10 dB higher value has to be reached, including the

hard floor coverings, as a compensation for the benefit of carpets that were generally in use in the early seventies and sixties of the 20<sup>th</sup> century, the period in which the requirements of 1976 were developed. Shortly after 1976 hard floor coverings came into use.

Abbreviations in the figures:

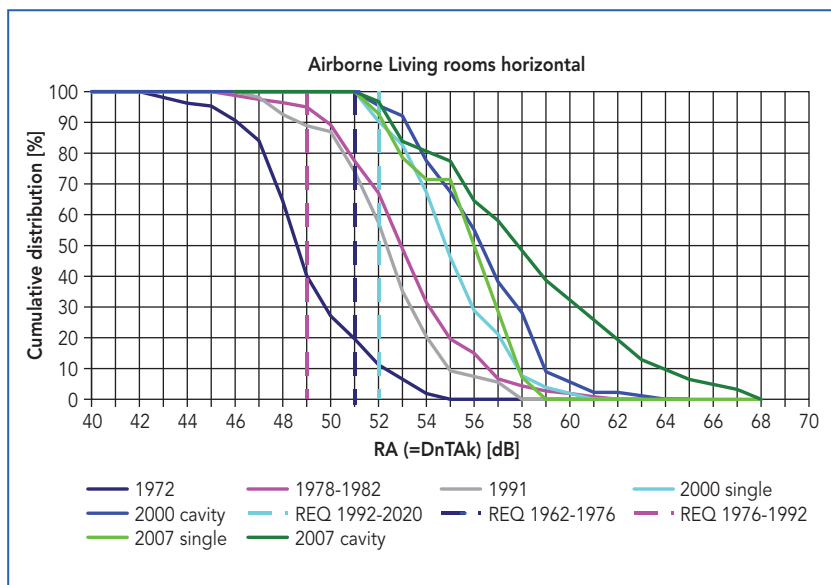
LR = Living room

BR = bedroom

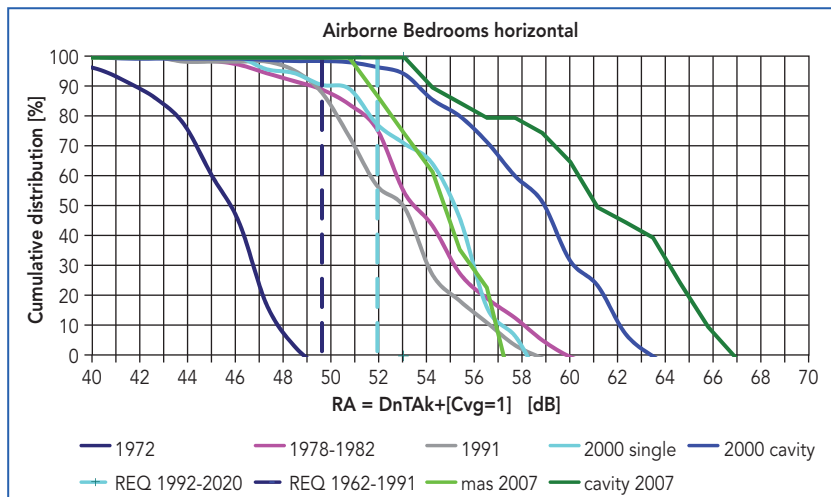
REQ = requirements

Some remarks on the figures 17.15 and 17.16

1. The airborne sound insulation of cavity walls is higher for bedrooms than for living rooms;
2. In 1972 the errors with façade elements led to lower values for bedrooms than for living rooms;
3. In the results of 1991 and 1978-1982 it was not possible to differentiate between cavity walls and massive walls, this is demonstrated by the slope of the curves in the higher values of the sound insulation.



**Figure 17.15.** Airborne sound insulation in horizontal direction for living rooms.



**Figure 17.16.** Airborne sound insulation in horizontal direction for bedrooms.

4. Note the big difference between 1972 and 1978-1982. The new knowledge and the introduction of NPR 5070:1977, based amongst others on studies of Gerretsen, 1979, and Louws, 2010, led to an increase of the performance quality during that period;
5. In 1991 there is a small decrease because the percentage of cavity walls was lower (from ca 40 to 15 %);
6. There is a difference between living rooms and bedrooms especially for the cavity walls, because the depth of the cavity is ca 3 m for the first floor and for the ground floor ca 0,4m.
7. A further increase after 1992 and 2003 is seen in the results because of the increase of the legal performance requirements in 1992 and 2003.

Some remarks on figures 17.17 and 17.18

1. In 1977-1982 the same curve for living rooms and bedrooms. The lower values are caused by the sound transmission via common ventilation ducts.
2. The airborne sound insulation increased gradually by the increasing mass of the partition floor.
3. The overall sound insulation can be further increased by a higher percentage of floating floors

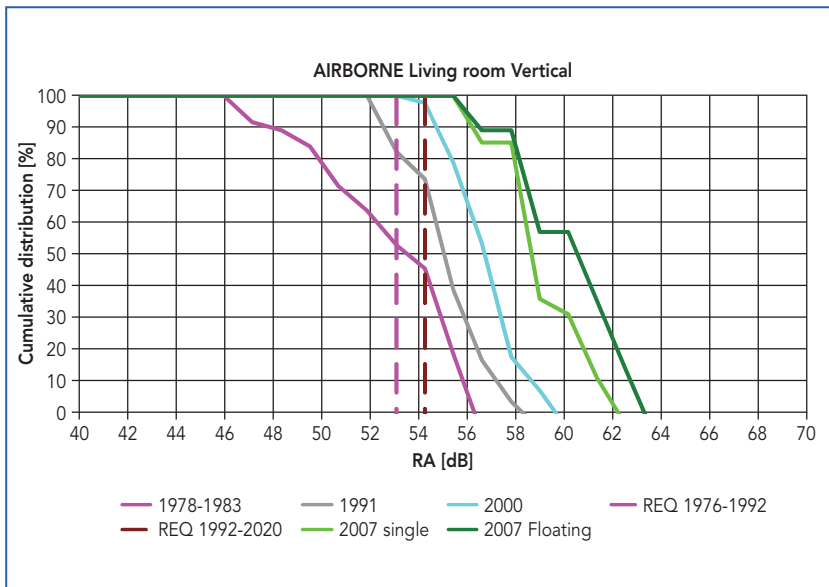


Figure 17.17. Airborne sound insulation in vertical direction for living rooms.

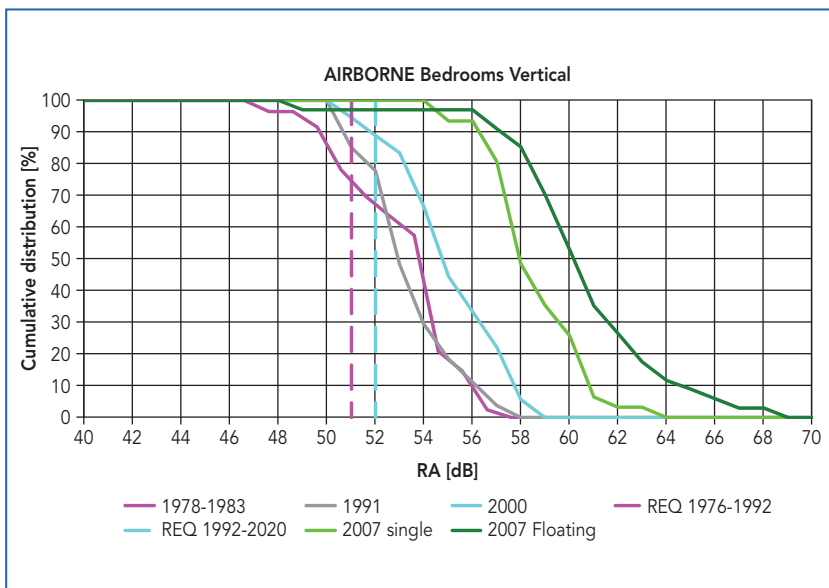
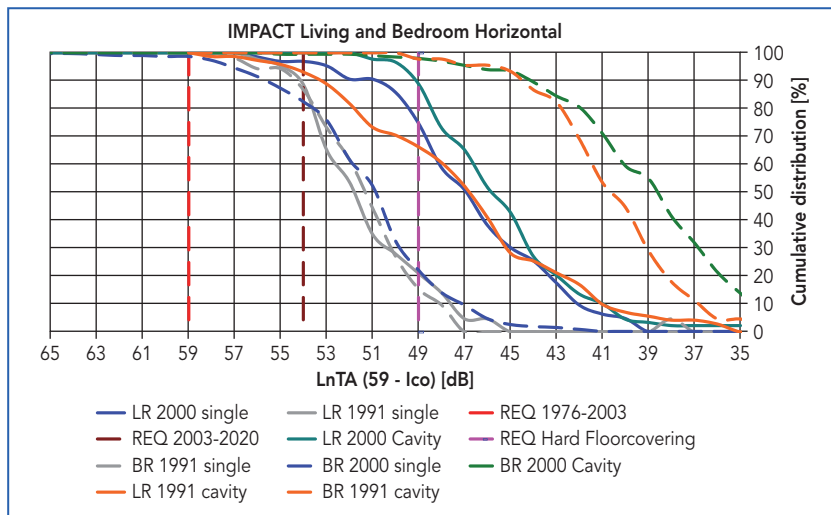


Figure 17.18. Airborne sound insulation in vertical direction for bedrooms.



**Figure 17.19.** Impact sound insulation in horizontal direction for living rooms and for bedrooms.

Remarks on figure 17.19:

1. In 1972 and during the 1978-1983 period there was insufficient data available. For the investigation in 2007 the impact sound in the horizontal direction was not included;
2. In 1991 for massive constructions the impact sound insulation between living rooms and bedrooms is very similar;
3. After 1991 there is a difference between the massive constructions between living rooms and bedrooms because of the flexible junction between the ground floor and the partition wall (traditionally the place of the living room). The impact sound insulation of the bedrooms with massive partition walls did not change in respect to the results of 1991, because the rigid junction between the partition wall on the first and second floor did not change;
4. The results of the living rooms with cavity walls and massive partition walls with flexible junction with the ground floor gave nearly the same results.
5. The results for the cavity walls between the bedrooms (mostly on the first floor) are much better than the results of the ground floor (living rooms). This is because of the higher distance (3,0 m) between the first floor and the foundation in respect to the distance between the ground floor and the fundament. (ca 0,4 m)

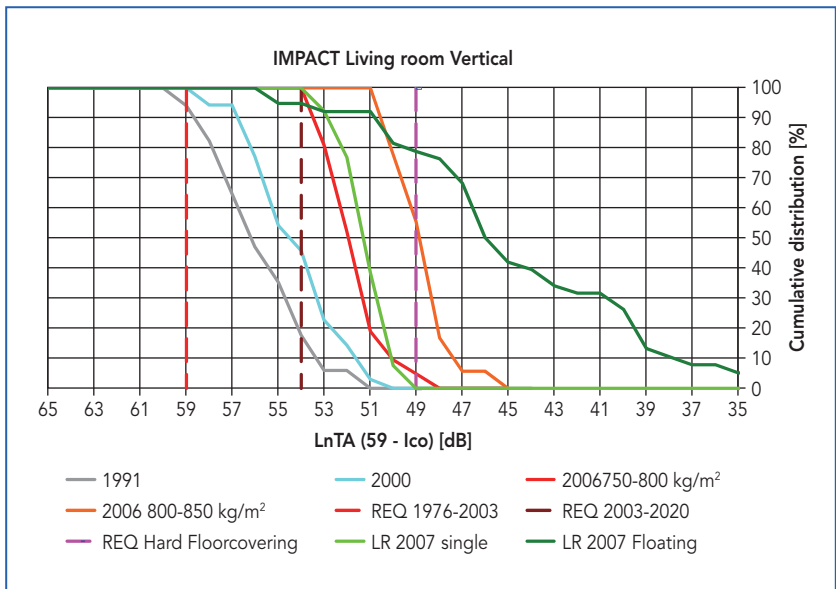


Figure 17.20. Impact sound insulation in vertical direction for living rooms.

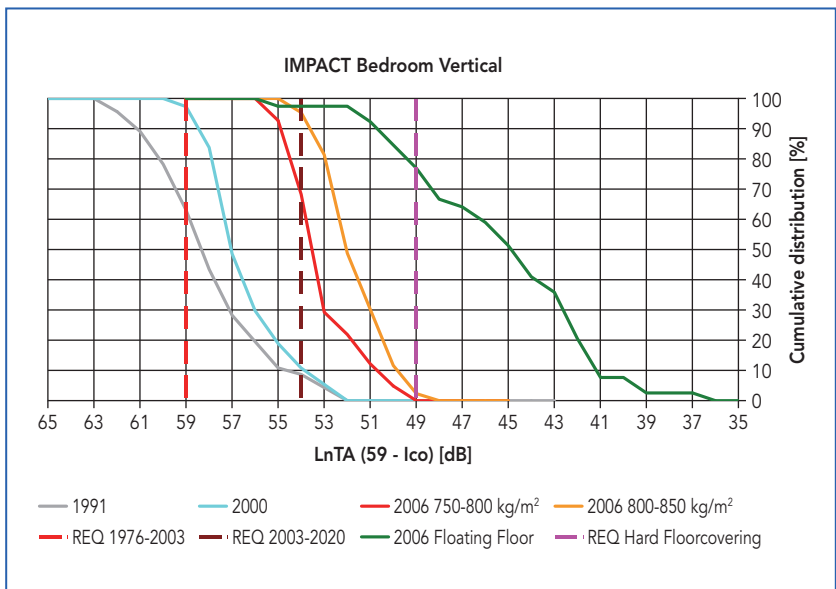


Figure 17.21. Impact sound insulation in vertical direction for bedrooms.

Remarks on figures 17.20 and 17.21

1. From figure 17.21 it becomes clear that  $600 \text{ kg/m}^2$  is needed to reach the requirements ( $L_{nT,A} \leq 59 \text{ dB}$ ) for bedrooms. In 1991 ca 40 % did not meet the requirements; after 1992 97 %.
2. There is a difference between the results for living rooms and bedrooms caused by the difference in volume of these rooms. Because the impact sound insulation is standardized to a reverberation time of 0,5 s, there is no correction for this volume-effect.
3. The impact sound insulation of partition floors *with* floating floors is better than without. The spread in the floating floor results is much higher than in massive floors. That is caused by the different types of floating materials, the spread in thickness of the concrete floor and the floating floor and the faults that were made in the building process. Even then the quality of floating floors is much better than that of solid floors.

## 17.2. References

- [1] W.G.M. Beentjes, 1992: Acoustic quality of newly built dwellings, period 1991. Bouwcentrum Advies Maarssen report 6570, February 1992 (Dutch).
- [2] W.G.M. Beentjes, 2011: Sound insulation in the Netherlands between 1970 and 2010 Proceedings Forum Acousticum 2011 at Aalborg Cost Action TU0901 paper 499 June 2011 at Aalborg (Denmark) (English).
- [3] J. van den Engel, J. Dessing, W.G.M. Beentjes, J.W. Niggebrugge, J. van Bree, and L.C.J. van Luxemburg 2006. "The sound insulation of solid partition floors and how to achieve the requirements  $I_{co} \geq +5 \text{ dB}$ ". Report of a meeting at 22 February 2006 at the office of consultancy Nieman (Dutch).
- [4] E. Gerretsen 1979, Calculation of the sound transmission between dwellings by partitions and flanking structures. Applied Acoustics 12 (1979), pp. 413–433. (English).
- [5] R.A.A. Hartman 1990; Sound insulation of wooden floors Report WG-DR-09-01} Ministry of housing (Dutch).
- [6] R.A.A. Hartman, L. Blokland and W.G.M. Beentjes, 1998: Scale 1:1 experiments on different types of junctions with a massive partition wall. CIB W51 meeting in CSTB at Paris, 7 and 8 September 1998 (English).
- [7] P. Kuindersma, C.J.W. Ruiters, 2007: Quality of inner environment in dwellings. Consultancy Nieman report Wu06315aaA4pk November 2007 (Dutch).



- [8] W.J. Lichtveld,1979: Sound transmission in cavities of roof constructions. NAG journal 47-8(1979) 93-110 (Dutch).
- [9] Sven Lentsen 2010: Presentation COST FP0702 workshop at Delft 2010 (English).
- [10] M.C. Louws, 2010: The history of the cavity wall in the Netherlands. Geluid 4 (2010) pg 6-10 (Dutch).
- [11] L.C.J. van Luxemburg 1984: Acoustical quality of newly built dwellings. Report 318.905 of FAGO-TNO-THE Eindhoven, September 1984 (Dutch).
- [12] J.N.M. van Rooijen,1975: Sound insulation between dwellings. Blueprint 3108 of Bouwcentrum Rotterdam (1975) and: Annoyance and sound insulation between dwellings NAG Journal 40 (1976) (Dutch).
- [13] R. van Schie, M.L.S. Vercammen, W.G.M. Beentjes, 2005: Acoustical quality of dwellings. NAG Journal 175 (May 2005) (Dutch).
- [14] Decree on sound insulation in buildings 1983. STB 1982 nr. 755 entered into force on 15 february. 1983 (Dutch).
- [15] SBR 2003 503a,b "Example projects to reach a higher sound insulation number 5: Timber Based Building type Volute The new Glass at Hoorn SBR 2003, Rotterdam (Dutch).
- [16] SBR 1992-2013: Reference details, comfort details, TB details, Renovation details: published since 1992, regularly improved and adapted to new legislation. The details are not only acoustic but also according to the regulations on thermal insulation, air tightness, condensation, etc. every detail has an attendance list but not a checklist.(Dutch) SBRCurnet, Rotterdam.
- [17] The Gypbox 2005, Renovation of building with the box in box method, Saint Gobain Gyproc Nederland BV Vianen 2005.
- [18] NPR 5070:1977, 1993 and 2005: Dutch Code of Practice. Examples of stony (and concrete) constructions to meet the sound insulation requirements. NEN Delft.
- [19] NPR 5086:2006 , Dutch Code of Practice Sound insulation of light weight partition walls NEN, Delft.

NAG = The Acoustic Society of the Netherlands.

NEN = The Dutch Standardization Organization.

NPR = Dutch Code of Practice.



# Building acoustics throughout Europe

## Volume 2: Housing and construction types country by country

# 18

## Norway

Authors:

**Clas Ola Høsøien<sup>1</sup>**  
**Iiris Turunen-Rindel<sup>2</sup>**

<sup>1</sup> Multiconsult as, Oslo, Norway e-mail: [clas.ola.hosoiien@multiconsult.no](mailto:clas.ola.hosoiien@multiconsult.no)

<sup>2</sup> Standards Norway, Oslo, Norway e-mail: [itr@standard.no](mailto:itr@standard.no)



## CHAPTER

## 18

## Norway

## 18.1. Design and acoustic performance: Norway

### 18.1.1. Overview of housing stock

This chapter presents an overview of the housing stock in Norway, based on data from the national statistical institute SSB (Statistisk sentralbyrå - <http://www.ssb.no/en/>).

Norway has a total population of approximately 5 million inhabitants (2013) [1].

The most populated cities are shown in table 18.1 [2].

**Table 18.1.** Most populated cities in Norway (2012).

City	Population
Oslo	607 690
Bergen	238 098
Trondheim	167 598
Stavanger	124 960

More than 70% of the dwellings in Norway are privately owned, and over 90% when dwellings owned by private companies and housing cooperatives are included [3].

Table 18.2 below shows the total number of dwellings by building type [3].

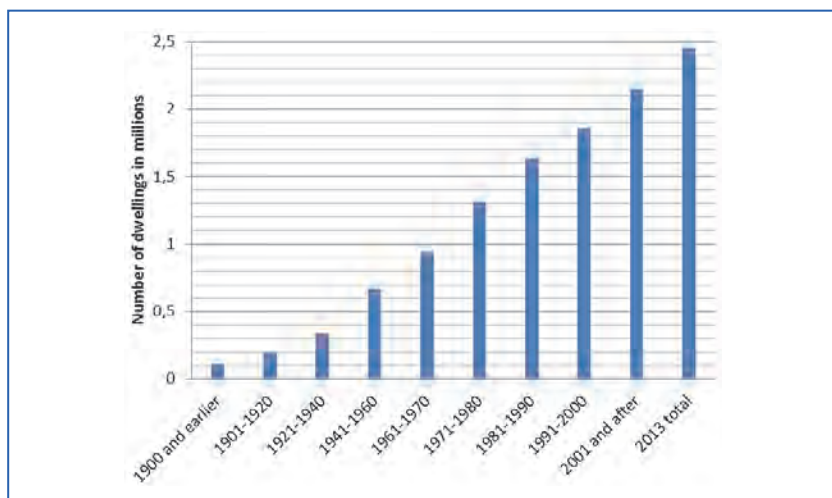
Figure 18.1 below shows the accumulated number of dwellings in Norway, from before 1900 until 2013 [3].

As can be seen in figure 18.1, the number of dwellings has been increasing almost linearly since 1960.

Figure 18.2 below shows the number of dwellings related to different building types and construction period [3].

**Table 18.2.** Dwellings (occupied and vacant), by building type (2013).

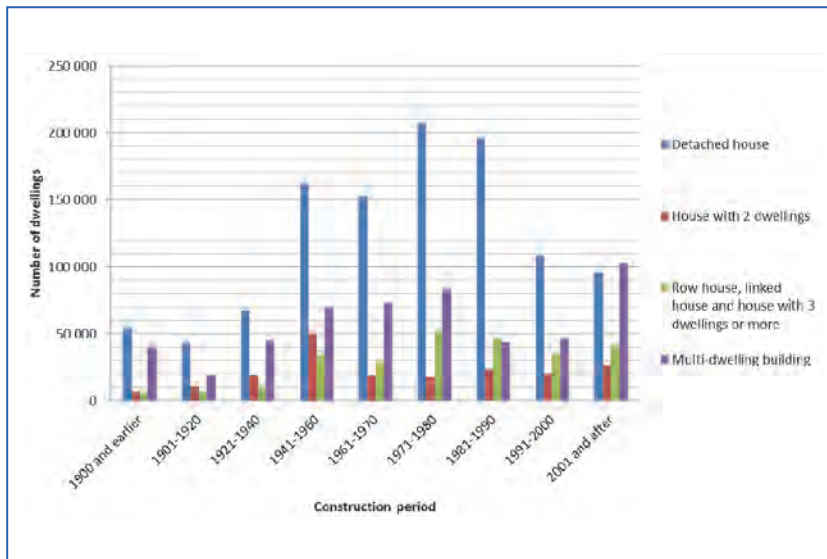
Building type	Number of dwellings
Detached house	1 278 960
House with 2 dwellings	223 783
Row house, linked house and house with 3 dwellings or more	281 360
Multi-dwelling building	550 366
Residence for communities	45 579
Other (mainly includes dwellings in garages, industrial buildings and other non-residential buildings)	69 162
Total	2 449 210



**Figure 18.1.** Accumulated total number of dwellings in Norway related to the year of construction.

Figure 18.2 shows that detached housing has been the most common dwelling type in Norway. During the last ten years, however, more multi-dwelling buildings than detached houses have been built.

The total number of dwellings built per year on a national level the last ten years ranges from around 20 000 (2009) to near 30 000 (2012), that is approximately 26 500 dwellings per year on the average since 2000 [4].



**Figure 18.2.** Number of dwellings related to building type and construction period.

## 18.1.2. New housing constructions

### 18.1.2.1. Regulations and requirements

The national requirements for sound insulation between dwellings have been more or less unchanged since 1987, with a minor adjustment in 1997 for multi-dwelling buildings, bringing the requirements for this building type to the same level as the requirements for row houses/attached houses/etc.

The requirements in 2013, as given in the national standard NS 8175, are [5]:

- Weighted apparent sound reduction index,  $R'_w \geq 55$  dB, between dwellings.
- Weighted normalised impact sound pressure level,  $L'_{n,w} \leq 53$  dB, from one dwelling to another.
- Weighted apparent sound reduction index,  $R'_w \geq 60$  dB and weighted normalised impact sound pressure level,  $L'_{n,w} \leq 48$  dB, from premises for commercial use or similar, to a dwelling.

- Indoor sound pressure level from building service equipment,  $L_{p,A,F,max} \leq 32$  dB and  $L_{p,A,T} \leq 30$  dB.
- Indoor sound pressure level from outdoor noise sources such as traffic etc.,  $L_{p,A,F,max} \leq 45$  dB (night) and  $L_{p,A,24h} \leq 30$  dB.
- Requirements for reverberation time in corridors is  $T \leq 1,0$  s, and in stairwells  $T_h \leq 0,27 \times h$  s ( $h$  is room height in meters) in octave bands from 250 Hz to 2 kHz.

There is in other words no specific requirement for facade insulation, as the required insulation will depend on the noise level outside the building.

In some separate rooms, as kitchen, bathroom, toilet and similar rooms, 5 dB higher indoor sound pressure level from building service equipment are accepted.

#### 18.1.2.2. Terraced housing

Row houses/attached houses are most commonly built with lightweight constructions, both separating walls between dwellings, and facades. With dwellings on two floors above each other, the separating floor construction is typically a lightweight wood construction.

A generic detail with separating wall and floor between dwellings in this building type is shown in figure 18.3. The example shows a solution with the ceiling in the lower dwelling mounted on wooden beams separated from the load-bearing beams.

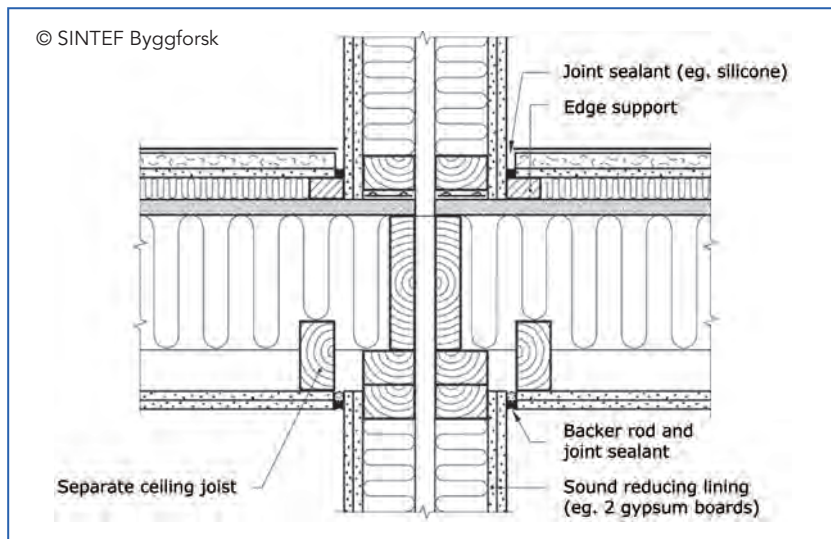
Description of typical separating wall:

- 2 × 13 mm gypsum boards on separate studs with 70 mm insulation - 20-30 mm air cavity - 2 × 13 mm gypsum boards on separate studs with 70 mm insulation.

Description of typical separating floor:

- Lightweight floating floor (parquet, resilient layer, 22 mm flooring particle board, 20 mm mineral wool), load-bearing wood beams with mineral wool in cavity, 2 × 13 mm gypsum boards on separate beams or resilient bars/hangers.

The most typical heavy construction in terraced housing is the base plate - usually 80-100 mm *in situ* cast concrete on insulation layer directly on the ground.



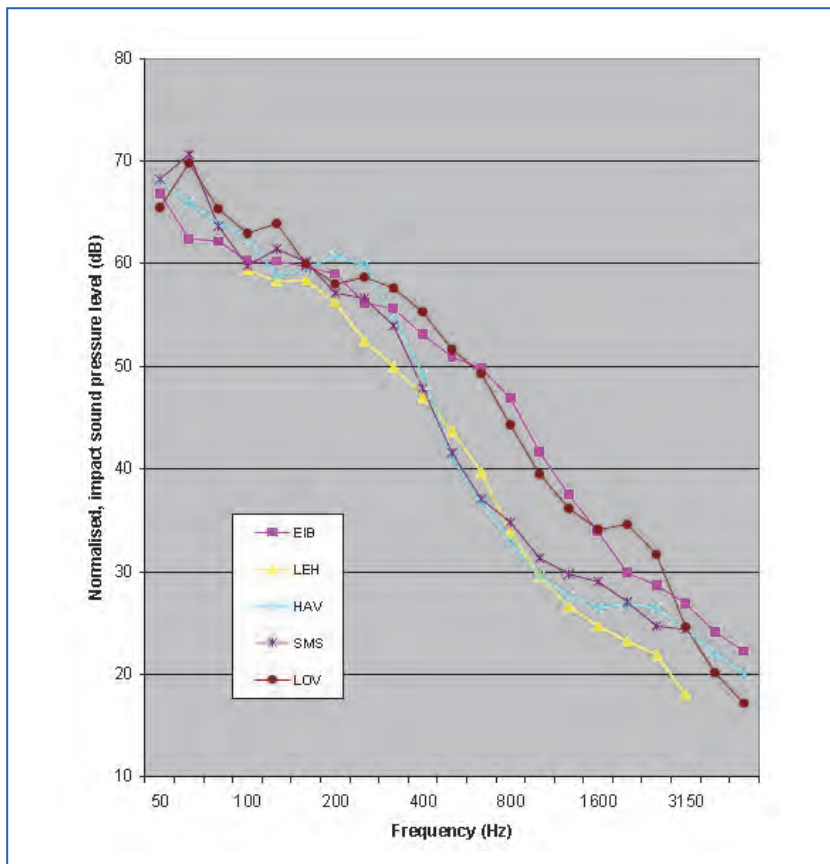
**Figure 18.3.** Generic detail showing typical separating wall and floor and the junction between them in terraced housing (Illustration: Byggforskserien 522.511, SINTEF Byggforsk) [6].

Typical errors in workmanship are:

- Joints between wall and floor/ceiling boards/sheets are not properly sealed.
- Stairs are rigidly connected to floors and separating walls.
- The concrete base plate is not properly detached between dwellings.

The constructions described in this chapter will in most cases fulfil the minimum requirements, but complaints have been registered, especially where measured values for impact sound pressure levels are just within the requirements. The reason for this is most likely related to high levels in the frequency range 50-100 Hz, as the  $C_{i,50-2500}$  adaptation term can be as high as +8 dB, resulting in  $L'_{n,w} + C_{i,50-2500} > 58$  dB.

Figure 18.4 below shows some typical results for impact sound pressure levels on lightweight wooden floors as described above, with measured results in the range  $L'_{n,w} = 49$ -54 dB, and  $L'_{n,w} + C_{i,50-2500} = 56$ -59 dB. This construction will not fulfil requirements for sound insulation (impact sound and sound reduction) between premises for commercial use and dwellings.



**Figure 18.4.** Typical impact sound pressure levels on various lightweight wooden floors [7], as described in the text above.

### 18.1.2.3. Apartments/flats

Multi-dwelling houses are typically built with heavy floors:

- 260 mm in situ cast concrete (approximately 620 kg/m<sup>2</sup>) or 320 mm prefabricated hollow core concrete slabs (approximately 530 kg/m<sup>2</sup>).

Impact sound insulation is typically taken care of by parquet on resilient layer.

Walls separating dwellings are typically the same lightweight constructions as described for dwellings in terraced housing.



Heavy separating walls are typically 200-250 mm concrete, either cast *in situ* or prefabricated elements.

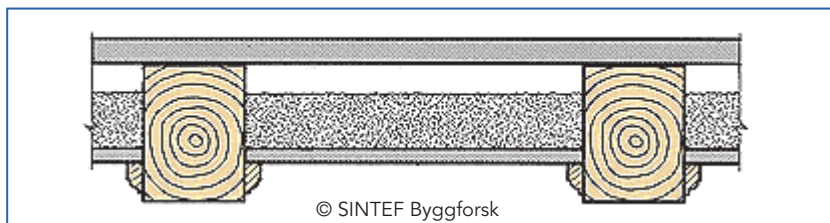
Typical errors in workmanship are:

- Joints between walls and floors/ceilings are not properly sealed.

### 18.1.3. Existing housing

Typical constructions found in existing stock

Typical floor construction, used in multi-dwelling buildings between 1850 and 1930 (when concrete floors became more common), is shown in figure 18.5 below. Facades and walls separating dwellings for this type of building are typically brick wall (masonry), with wall thickness minimum 250 mm.



**Figure 18.5.** Typical floor construction in multi-dwelling buildings from the period 1850-1930 in Norway (Illustration: Byggforskserien 722.310, SINTEF Byggforsk) [8].

The acoustical performance for this floor construction is quite poor, and typical values for sound insulation are  $R'_w = 35-45$  dB and  $L'_{n,w} = 65-75$  dB, depending on type and number of layers on the floor and on the ceiling construction. Building regulations before 1987 may be found on website [9].

Methods for improving sound insulation for these constructions are typically a lightweight floating floor and suspended sound insulating ceiling consisting of gypsum boards. Carried out correctly, the improvements can give results that satisfy the current requirements. This will also be the case for concrete floors with thickness less than 200 mm.

When separating walls are made of massive bricks with wall thickness minimum 250 mm, sound insulation horizontally is seldom a problem.

Facades and separating walls of timber logs were typical for two-storey buildings with 3-4 apartments. In these cases, additional linings on both

sides of the separating wall are necessary in order to achieve satisfying sound insulation. The lining will typically be 2 × 13 mm gypsum boards on separate studs and mineral wool in the air cavities.

## 18.2. References

- [1] <http://www.ssb.no/en/befolkning/statistikker/folkemengde>
- [2] [http://no.wikipedia.org/wiki/Liste\\_over\\_Norges\\_st%C3%B8rste\\_tettsteder](http://no.wikipedia.org/wiki/Liste_over_Norges_st%C3%B8rste_tettsteder)
- [3] <http://www.ssb.no/en/bygg-bolig-og-eiendom/statistikker/boligstat>
- [4] <https://www.ssb.no/bygg-bolig-og-eiendom/statistikker/byggeareal/aar/2013-03-05>
- [5] Norsk standard NS 8175:2012 “Lydforhold i bygninger. Lydklasser for ulike bygningstyper”.
- [6] SINTEF Byggforsk, detaljblad 522.511 “Lydisolerende etasjeskillere med trebjelkelag”, 2002.
- [7] A. Homb (2006): Low frequency sound and vibrations from impacts on timber floor constructions, Appendix A, Ph.D. thesis.
- [8] SINTEF Byggforsk, detaljblad 722.310 “Etasjeskillere med trebjelkelag i eldre bolighus fra perioden 1850-1955”, 2007.
- [9] Norwegian Building Regulations before 1997. <http://oppslagsverket.dsb.no/content/arkiv/plan-bygg/>



# Building acoustics throughout Europe

## Volume 2: Housing and construction types country by country

# 19

## Poland

Authors:

A. Izewska

B. Szudrowicz

R. Ciszewski

Building Research Institute ITB.

© COST Office and authors (2014)

The responsibility and copyright of each chapter belongs to the author(s). When quoting, it is mandatory to make proper reference to the book and/or the authors of the quoted chapter. Permission from copyright holder is required in case of reproducing contents of images, diagrams, tables or other material from other copyright holders.



## CHAPTER

## 19

## Poland

## 19.1. Design and acoustic performance

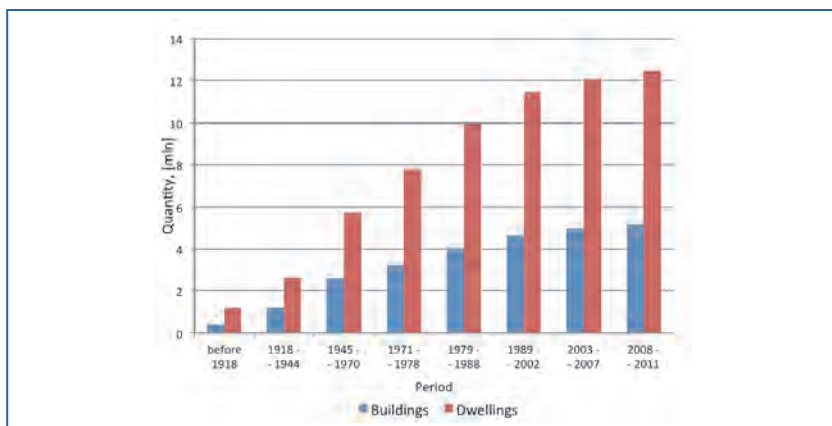
## 19.1.1. Overview of housing stock

*Population and housing stock*

In 2011, according to the census held by Central Statistical Office (GUS), Poland had approximately 38 million inhabitants [1]. Around 60% of them live in cities and 40% in rural areas.

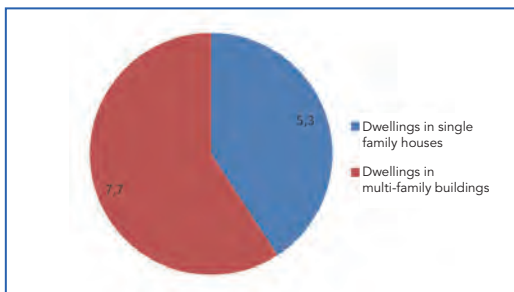
The housing stock in 2011 amounted to around 5.5 millions of build inhabited buildings [2] of which around 5 million were single family houses and the rest, about 0.5 million, multi-family buildings. Single family houses are defined by GUS [2] as buildings with 1 or 2 dwellings in detached or terraced development. Buildings with 3 or more dwellings are described as multi-family residential buildings. The total number of dwellings in 2011 amounted around 13 million (approximately 7.7 million flats, 5.3 million attached houses or single family houses).

Figure 19.1 shows the number of buildings and dwellings built over the years [2]. The figure does not include buildings with unknown period of construction.

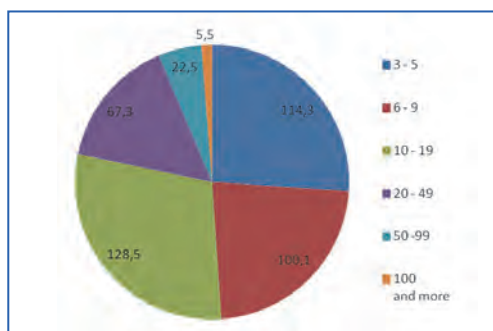


**Figure 19.1.** Number of buildings and dwellings per period (up to 2011).

Although the number of single family houses is much greater than the number of multi-family buildings, around 60% of the total number of dwellings is in multi-family buildings (Figure 19.2).

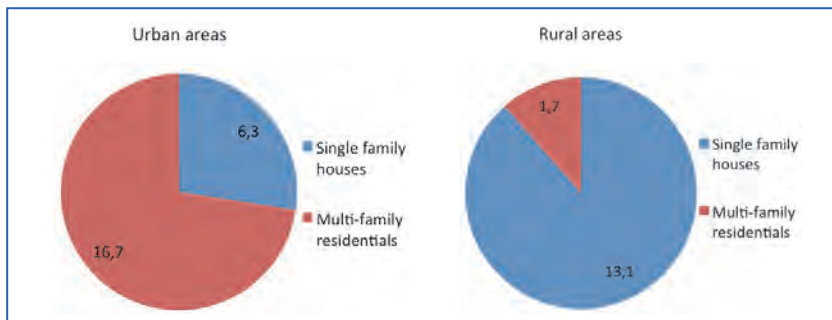


**Figure 19.2.** Number of dwellings (in millions) in single family houses and in multi-family residential buildings (in 2011).



**Figure 19.3.** Number of multi-family residential buildings (in thousands) in the cities by the number of dwellings in a building (in 2011).

The number of people living in dwellings in single family houses and in multi-family residential buildings is quite similar for the whole of Poland, about 19.5 and 18.5 million inhabitants respectively. It is worth however to consider urban areas, where the problem of noise pollution is of bigger importance, and rural areas separately. By doing so one will notice that in urban areas around 16.7 million people live in multi-family residential buildings and only 6.3 million in single-family houses (Figure 19.4, left). In rural areas the situation is opposite with 1.7 and 13.1 million inhabitants respectively (Figure 19.4, right).



**Figure 19.4.** Number of people (in millions) living in single-family houses and multi-family residential buildings in urban and rural areas separately (in 2011).

### The most populated cities

The most populated cities in Poland are [3]: Warszawa (1,71 million), Kraków (0,76 million), Łódź (0,72 million), Wrocław (0,63 million), Poznań (0,55 million) and Gdańsk (0,46 million).

### Typical building construction types

Following pictures show some examples of building typology divided per size and per construction period:

Period of construction	Single family buildings	Multi-dwelling buildings
before 1945		
1946 – 1969		

Period of construction	Single family buildings	Multi-dwelling buildings
1970s		
1980s		
1990s		
2000s		

### 19.1.2. Acoustic regulations for buildings

A listing of acoustic requirements for interior partitions over the years (starting from 1970 onwards) is presented in Table 19.1. Comparison of basic acoustic requirements for dwellings included in Polish standard PN – 02151 since 1970. Due to different type of indices used in different periods approximate values of  $R'_{w}$  and  $L'_{n,w}$  are given in brackets.



**Table 19.1.** Comparison of basic acoustic requirements for dwellings included in Polish standard PN – 02151 since 1970.

Partition	Requirements [dB] acc. to PN-02151 standards issued in year					
	1970		1987		1999	
	$E_L$	$E_T$	$R'_w$	$L'_{n,w}$	$R'_{A1} = (R'_w + C)$	$L'_{n,w}$
Walls between dwellings	$\geq -1$ ( $R'_w \geq 51$ )	–	$\geq 52$	–	$\geq 50$ ( $R'_w \geq 52$ )	–
Floors	$\geq -1$ ( $R'_w \geq 51$ )	$\geq 0$ ( $L'_{n,w} \leq 63$ )	$\geq 53$	$\leq 58$	$\geq 51$ ( $R'_w \geq 53$ )	$\leq 58$

Current requirements for sound insulation of internal and external partitions of residential buildings in Poland are set in the PN-B-0251-3:1999 standard.

The requirement for the façade sound insulation depends on the outside noise level. The minimal requirements for  $R'_w + C_{tr}$  (or in special cases  $R'_w + C$ , as specified in EN ISO 717 -1) are as follows:

**Table 19.2.** Requirements for the façade sound insulation in the Polish standard PN-B-0251-3:1999.

Outside noise level [dB]	Day	< 45	46 - 50	51 - 55	56 - 60	61 - 65	66 - 70	71 - 75
	Night	< 35	36 - 40	41 - 45	46 - 50	51 - 55	56 - 60	61 - 65
$R'_w + C_{tr}$ or $R'_w + C$ [dB]		20	20	23	23	28	33	38

For index calculations only third octave bands from 100 Hz to 3150 Hz are considered.

Permissible noise levels of service equipment in building are currently defined in PN-87-B-02151-2:1990. Requirements are set for every noise source separately as  $L_{Aeq}$  (not steady state noise) or  $L_{A,m}$  (steady state noise) and  $L_{A,max}$  and for all sources in a building together ( $L_{Aeq}$ ), for day and night separately (Table 19.3).



**Table 19.3.** Maximum admissible noise levels in rooms intended for living (bedrooms, living rooms etc.) acc. to PN-87-B-02151-2:1990.

From all sources		From each source			
$L_{Aeq}$ [dB]		$L_{Aeq}$ or $L_{A,m}$ [dB]		$L_{Amax}$ [dB]	
Day	Night	Day	Night	Day	Night
40	30	35	25	40	30

### 19.1.3. Typical multi-family building constructions

Until the 60s buildings in Poland were built as traditional constructions (masonry brick, stone constructions or wooden constructions). In the period of 1970 – 1990 prefabricated building constructions were predominant. Table 19.4 gives an overview of typical construction types of multi-family residential buildings built in the period from 1970 until 1990.

After 1990 the type of construction changed considerably. Although there still are predominantly massive constructions in Poland, more masonry systems have appeared incorporating materials with better thermal properties (Table 19.5). Most of the buildings are erected as monolithic constructions with reinforced concrete frame (examples of floor constructions - Table 19.6) and the non-load bearing walls built as single or double layers made of ceramic, calcium-silicate or autoclaved cellular concrete (ACC) bricks.

**Table 19.4.** Typical multi-family building construction types built in Poland in the period of 1970-1990.

System	Walls	Floors*	Facades	Sound insulation in the building	
				Walls	Floors
Prefabricated concrete construction					
Five different systems (W-70, Wk-70, S, WUF-T, OWT-67)	Mainly reinforced concrete slab (full) 14 ÷ 15 cm, some double layer gypsum block (8cm gyp. bl. – 5 cm void – 8 cm gyp. bl.)	Full 14 cm or channelled 22 cm reinforced concrete slabs	3-layer reinforced concrete slabs (with thermal insulation: mineral wool or polystyrene) or masonry walls (e.g. ACC blocks)	Reinforced concrete 14-15 cm $R'_w = 51 \pm 4$ dB Gypsum dbl. layer $R'_w = 46 \pm 1$ dB	with floating floor $R'_w = 52 \pm 2$ dB $L'_{nw} = 61 \pm 4$ dB with screed and PVC covering $R'_w = 51 \pm 4$ dB $L'_{nw} = 59 \pm 4$ dB
Żerań	Channelled 24 cm reinforced concrete slabs	Channelled 24 cm reinforced concrete slabs	Masonry walls (e.g. ACC blocks)	–	–

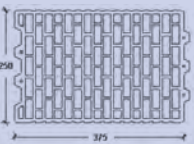
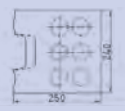
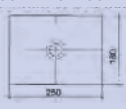



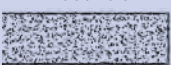
System	Walls	Floors*	Facades	Sound insulation in the building	
				Walls	Floors
Monolithic construction					
SBM-75	Reinforced concrete slab (full) 15 cm	Reinforced concrete slab (full) 16 cm	3-layer reinforced concrete slabs or masonry walls (e.g. ACC blocks)	$R'_w = 54 \pm 1$ dB	with screed and PVC covering $R'_w = 55 \pm 1$ dB $L'_{nw} = 56 \pm 3$ dB

\*) Flooring types:

- 4 cm screed on resilient layer (porous fibreboard, mineral wool);
- 4 cm screed + PVC carpet with soft under layer.

**Table 19.5.** Typical wall types in multi-family buildings built in Poland after 1990.

Material type	Building construction system	Wall between dwellings		$R_{w+C}$ dB	$R'_{w+C}$ dB
		Type (examples)	Surface mass of the wall with 10 mm plaster		
Ceramic hollow brick	Masonry construction	Single layer - 25 cm hollow brick	250 kg/m <sup>2</sup>	51-52 dB	-
	Reinforced concrete frame <sup>1)</sup>				47 ± 2 dB
	Reinforced concrete frame <sup>1)</sup>	Double layer - 8-12 cm hollow brick + mineral wool 5 cm	220-230 kg/m <sup>2</sup>	-	48 ± 2 dB
Calcium-silicate brick	Masonry construction	Single layer - 24 cm hollow brick	330-350 kg/m <sup>2</sup>	54 dB	51 ± 1 dB
	Reinforced concrete frame <sup>1)</sup>				49 ± 1 dB
	Masonry construction	Single layer - solid bricks 180 mm or 250 mm	355 kg/m <sup>2</sup> h = 180 mm	56 dB h = 180 mm	-
	Reinforced concrete frame <sup>1)</sup>		485 kg/m <sup>2</sup> h = 250 mm	58 dB h = 250 mm	-

Material type	Building construction system	Wall between dwellings		$R_w+C$ dB	$R'_w+C^2$ dB
		Type (examples)	Surface mass of the wall with 10 mm plaster		
Concrete hollow brick	Reinforced concrete frame <sup>1)</sup>	Single layer - 18 cm hollow brick 	265 kg/m <sup>2</sup>	55 dB	48 ± 1 dB
Concrete precast elements	New generation prefabricated system	Precast reinforced concrete slab 15 cm 	380 kg/m <sup>2</sup>	56 dB	51 ± 1 dB

<sup>1</sup> A gap is left at the top edge of a partition wall between dwellings to compensate for the floor deflection; the gap is filled with mineral wool or polyurethane foam etc.

<sup>2</sup> The spread of results is caused by: different material type used within one construction system; differences in flanking transmission; quality of workmanship;

**Table 19.6.** Typical floors types in multi-family buildings built in Poland after 1990.

Construction type	$R'_w+C^1$ dB	$L'_{n,w}^1$ dB
Full 16 ÷ 24 cm or channelled 24 cm reinforced concrete slabs with floating floor	54 ± 3 dB	Wooden covering 50 ± 6 dB  Ceramic covering 50 ± 6 dB

<sup>1</sup> The spread of results is caused by: different construction type, different resilient layer in floating floors; differences in flanking transmission; quality of workmanship;

### 19.1.4. Typical errors in workmanship

Heavyweight walls (in current constructions: predominantly masonry walls).

- Sloppy execution of vertical connections between bricks (brick not put tightly enough or not enough mortar).
- Distance between separating wall and outside wall too big and poorly insulated.
- Insufficient insulation of the gap between wall and ceiling.
- Usage of drywall linings attached with “mortar points” to massive walls. The difference when compared with a plastered wall may amount even up to 9 dB, depending on workmanship (Figure 19.5).

- Installation of electrical wires and water pipes in a cut out groove in the wall.
- Installation of electrical sockets symmetrically on both sides of the wall.
- Thermal insulation of the façade with the use of polystyrene instead of mineral wool (Figure 19.6).

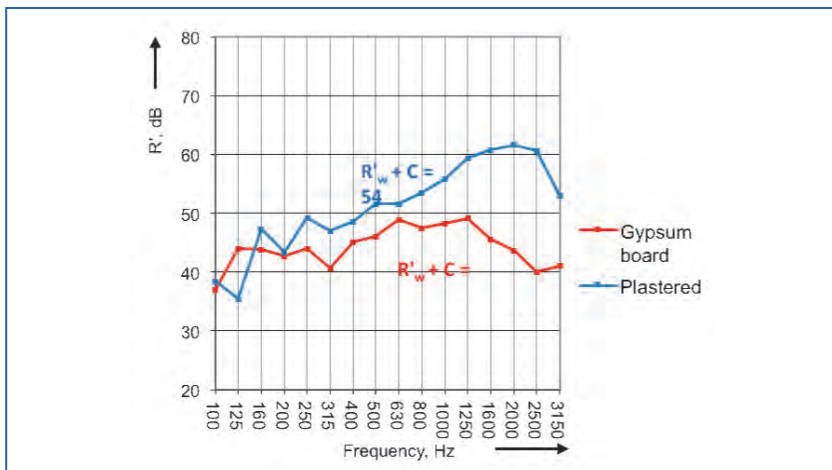


Figure 19.5. Example of an airborne sound insulation of a masonry wall lined with gypsum boards attached with “mortar points” and plastered.

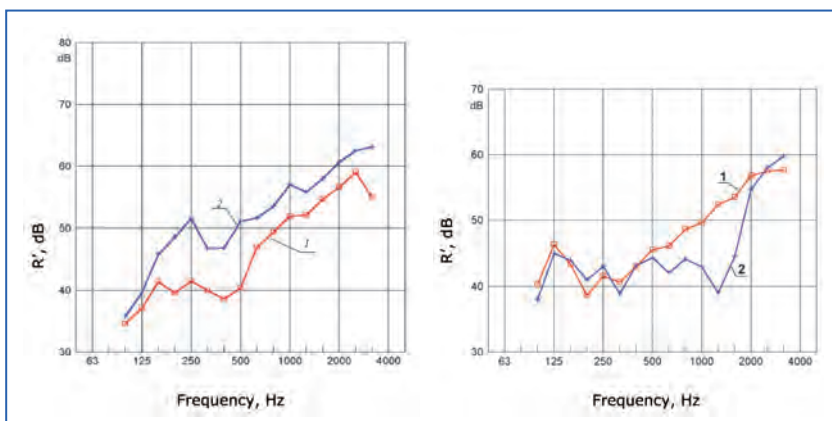
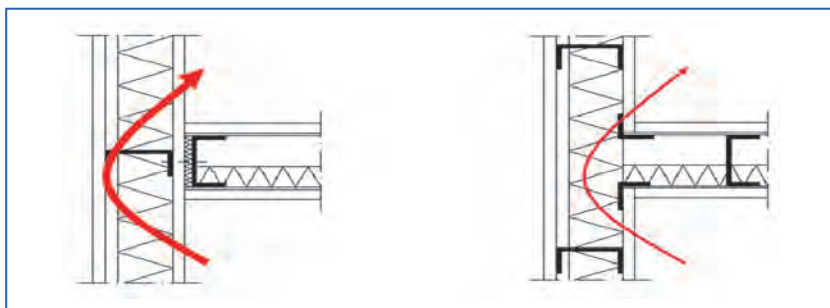


Figure 19.6. Airborne sound insulation of a façade with plastered thermal insulation made of mineral wool (left) and polystyrene (right);  
 1. Façade without thermal insulation; 2. Façade with thermal insulation;

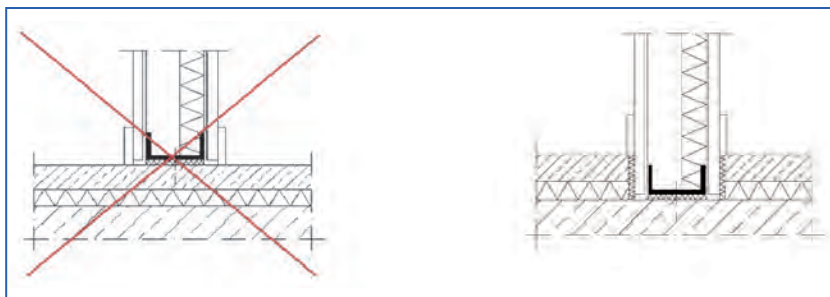


## Lightweight walls

- Deviations from system solutions of lightweight walls with aluminium frame (lack of resilient pads, changes in the type of connection between the wall and surrounding partitions (*Figure 19.7*).
- Wall built on top of floating floor (*Figure 19.8*).
- In case of walls built on top of raised floors or under suspended ceilings – inappropriate design or execution of insulation of the plenum.



**Figure 19.7.** Connection of lightweight walls with aluminium frame;  
Left: faulty solution; Right: correct solution.



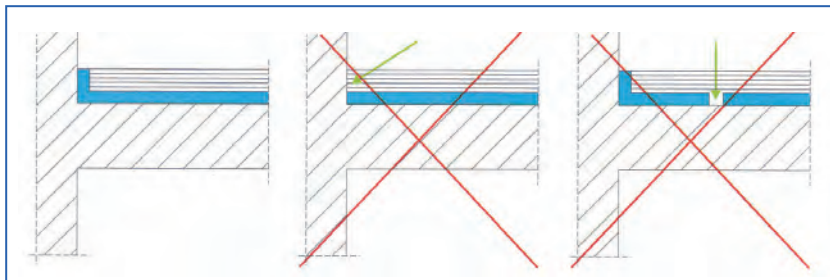
**Figure 19.8.** Lightweight wall built on top of the floating floor (left) - faulty solution and the correct solution with the wall built directly on the supporting floor structure.

## Floating floors

- Resilient layer under the screed made of EPS polystyrene instead of EPS-T polystyrene



- Sloppy execution of damp-proof layer – if not continuous the risk exists that the screed will pour down through the gap between plates of resilient material forming an acoustical bridge between the screed and supporting floor (*Figure 19.9, right*);
- Rigid connection between ceramic tiles or floating floor screed and the wall (*Figure 19.9, center*).



**Figure 19.9.** Examples of floor construction. a) Floor made with no error; b) Flooring with rigid connection to the wall; c) Acoustical bridge between flooring screed and supporting floor.

## 19.2. References

1. Ludność. Stan i struktura demograficzno-społeczna. Narodowy Spis Powszechny Ludności i Mieszkań 2011. Główny Urząd Statystyczny, Warszawa 2013, <http://www.stat.gov.pl/>.
2. Zamieszkałe Budynki. Narodowy Spis Powszechny Ludności i Mieszkań 2011. Główny Urząd Statystyczny, Warszawa 2013, <http://www.stat.gov.pl/>.
3. Największe Miasta Pod Względem Liczby Ludności – Stan na 31.12.2011, Główny Urząd Statystyczny.
4. Narodowa Agencja Poszanowania Energii SA, Polish Building Typology – TYBULA – Scientific Report, Warsaw 2012, <http://www.building-typology.eu/>.
5. Szudrowicz B., Nowicka E. – Błędy w projektowaniu i wykonawstwie izolacji akustycznych (Design and execution defects of acoustic insulations), Conference Izolacje 2013, Warsaw 2013.
6. Szudrowicz B. – Ocena izolacyjności akustycznej przykładowych rozwiązań ścian międzymieszkaniowych we wznoszonych obecnie budynkach wielorodzinnych (Assessment of acoustic insulation of exemplary solutions for interdwelling partition walls in currently erected multifamily buildings), Building Research Institute – Quarterly No 1 (137), Warsaw 2006.

# Building acoustics throughout Europe

## Volume 2: Housing and construction types country by country

# 20

## Portugal

Authors:

**Julieta António<sup>1</sup>**  
**Jorge Patrício<sup>2</sup>**  
**Sónia Antunes<sup>2</sup>**

COST Action  
TU0901



<sup>1</sup> University of Coimbra, Coimbra, Portugal

<sup>2</sup> LNEC, Lisbon, Portugal



## CHAPTER

## 20

## Portugal

## 20.1. Design and acoustic performance

### 20.1.1. Overview of housing stock

The information on housing stock, building type and population provided in this section was mainly obtained from INE [1] (National Institute of Statistics).

#### *The amount of housing stock and total population*

According to the 2011 Census [1], the resident population of Portugal is 10.5 million. In 2011, the Portuguese building stock was about 3.5 million. The number of dwellings is around 5.8 million, 5.1 million of which are occupied.

The 2011 Census revealed a considerable increase in the number of dwellings (16.3%) and buildings (12.4%), which is in line with the trend over the last thirty years. However, the increase in the number of dwellings was smaller than in previous decades: 20.5% in 2001, and 22.1% in 1991.

Classic dwellings used as ordinary residences have an habitable area of 109 m<sup>2</sup> with 5 rooms for accommodation, and are occupied on average by 2.6 people. Figure 20.1 shows how the number of dwellings has increased over recent decades, according to Census data.

According to estimates based on the total number of constructed buildings, in 2009 the total number of new housing constructions in Portugal was 22 023, of which 19 411 are individual dwellings (detached and not detached) and 2 612 are apartment blocks.

Figures 20.2 and 20.3 illustrate the types of Portuguese buildings according to specific periods: Figure 20.2 apartment block; Figure 20.3 individual dwellings.

#### *The most populated cities*

The most populated cities in Portugal are Lisbon (0.55 million), Vila Nova de Gaia (0.32 million) and Porto (0.24 million) [2]. The metropolitan area of Lisbon has around 2.8 million inhabitants, which is about 20% of the population of Portugal occupying 3% of the national territory.



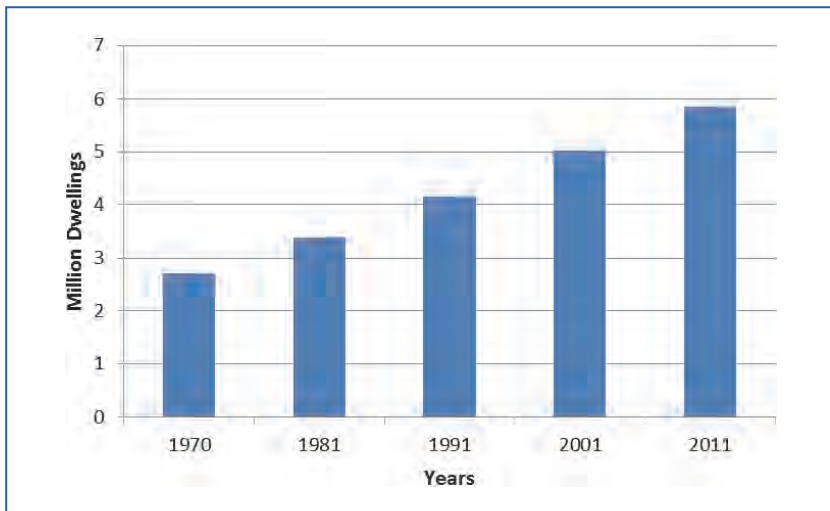


Figure 20.1. Number of dwellings [1].



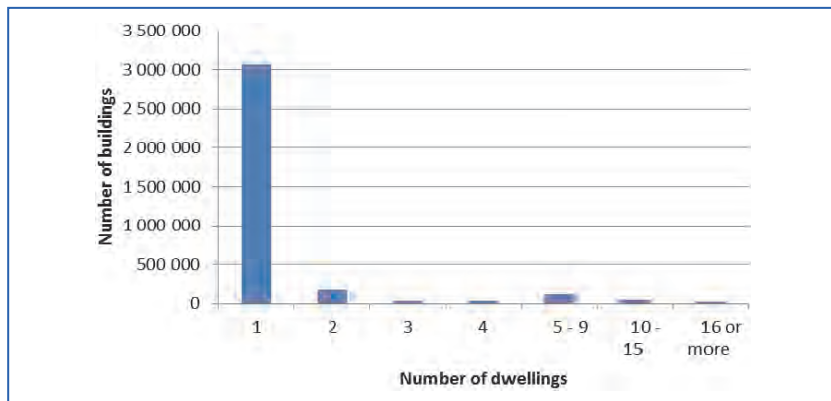
Figure 20.2. Apartment block: a) 1950-60s; b) 1970-80s; c) 2000-10s.



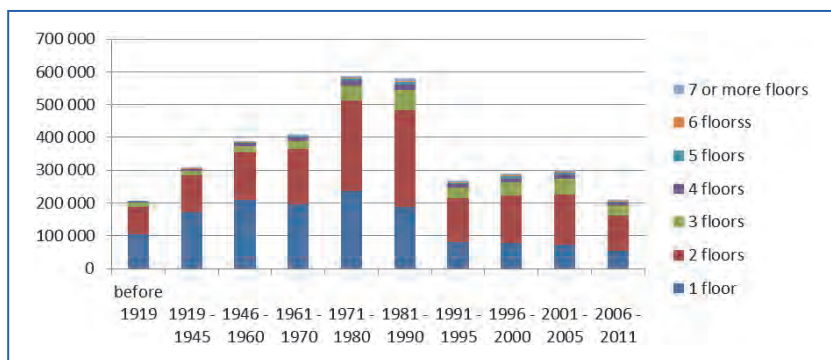
Figure 20.3. Individual dwellings: a) 1950-60s; b) 1970-80s; c) 2000-10s.

*Proportion of apartments, terraced (row) and detached houses [1]*

The available data make it difficult to distinguish apartments and houses. However, the distribution of dwellings per building can be estimated, as seen in Figure 20.4. Figure 20.5 shows the number of floors per building, according to the period of construction.



**Figure 20.4.** Buildings, according to the number of dwellings [1].



**Figure 20.5.** Buildings, by number of floors, relative to the construction period [1].

**20.1.2. New build housing construction**

*Legislation on building acoustics*

In Portugal, the building acoustics legislation (Decreto-Lei 96/2008 [10]) prescribes minimum requirements for residential buildings, as follows:

- Façade sound insulation,  $D_{2m,nT,W} \geq 28$  dB for sensitive areas and  $D_{2m,nT,W} \geq 33$  dB for mixed areas. This type of area should be classified in accordance with land use planning regulations, based on environmental noise mapping.
- Airborne sound insulation index between dwellings,  $D_{nT,W} \geq 50$  dB.
- Impact sound insulation between dwellings,  $L'_{nT,W} \leq 60$  dB.
- Equivalent SPL from service equipment operating continuously,  $L_{A,eq} \leq 27$  dB(A).
- Equivalent SPL from service equipment operating intermittently,  $L_{A,eq} \leq 32$  dB(A); ( $L_{A,eq} \leq 40$  dB(A) for emergency electricity generators).

The sound insulation single numbers are calculated in one-third octave frequency bands from 100 Hz to 3150 Hz. The requirements do not consider spectrum adaptation terms except for façades when the translucent area is greater than 60% of the façade element (in which case, and taking into account the characteristics of outside noise, the terms C or  $C_{tr}$  must be added, keeping the legally established limits).

### *Typical heavyweight constructions*

The most common building types use heavyweight constructions, although lightweight constructions have become more common in the last decade, especially in service/office buildings.

Typical double walls in Portugal (façade or separating dwellings) are made of:

- hollow brick 15 cm thick (Figure 20.6a) – air cavity – hollow brick 15 cm thick
- hollow brick 15 cm thick – air cavity – hollow brick 11 cm thick (Figure 20.6b)
- hollow brick 15 cm thick – air cavity – hollow brick 9 cm thick (Figure 20.6c)

In Figure 20.6d some examples of concrete blocks that are also used in buildings are shown.

The air cavity is usually either fully or partially filled with thermal insulation material (mineral wool, EPS, XPS).

Other types of bricks or blocks designed for acoustic and thermal purposes can be applied in a single layer. However, their use is not yet generalized (Figure 20.7).

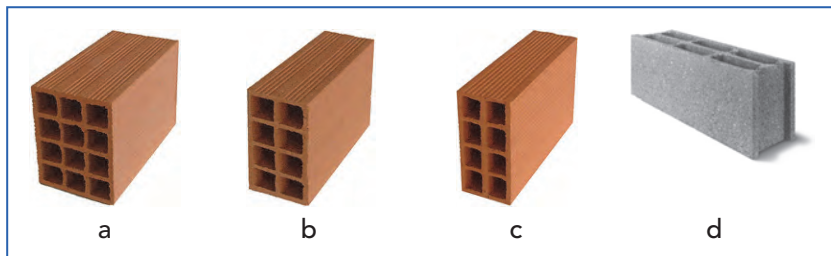


Figure 20.6. Examples of blocks used in walls.



Figure 20.7. Example of thermal and acoustic block.

Concerning floors, floating concrete floors are not widely used, though this is a trend in buildings designed to have better acoustic performance.

The typical slab is a solid or hollow concrete slab, with thickness ranging from 12 to 30-35 cm, supported by beams or directly by columns.

Airborne sound insulation results of *in situ* measurements are shown in Figure 20.8 to illustrate the performance of some separating walls. These examples do not represent all applications, since the construction technique and the adjacent constructive elements can greatly influence the sound insulation. In Figure 20.8, curve a) represents a wall cavity with two panels of hollow clay blocks 11 cm thick, plastered on both sides (20 mm) with an empty cavity [ $D_{nT,w}(C ; C_{tr})= 50(-1;-4)$  dB]. Curve b) represents airborne sound insulation for a double wall partition composed of hollow clay brick panels, one 15 cm thick and the other 9 cm thick. The wall is plastered on both sides with 150 mm layer of mortar and the air cavity between the panels (4 cm thick) is filled with mineral wool [ $D_{nT,w}(C ; C_{tr})= 50(0;-3)$  dB]. Curve c) represents a high performance wall, which is a double masonry wall built with “thermal” blocks, each layer 20 cm thick, plastered with 20 mm of mortar on both sides, with an air cavity of 3 cm containing thermal insulation of extruded polystyrene [ $D_{nT,w}(C ; C_{tr})= 69(-2;-7)$  dB].

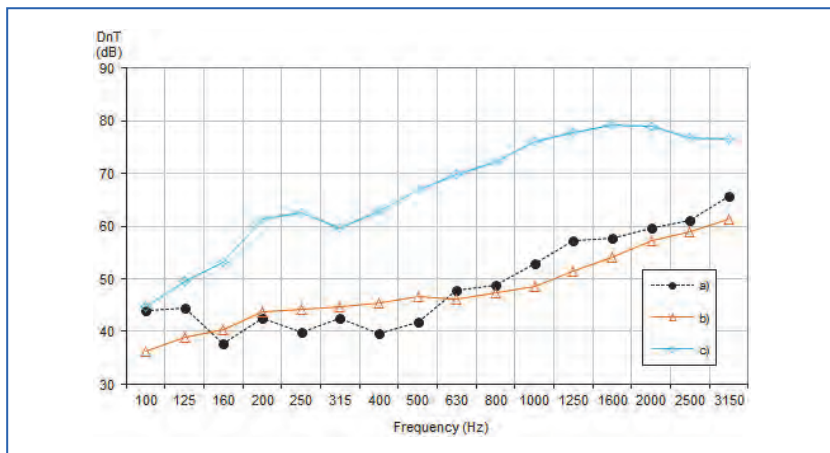


Figure 20.8. Examples of airborne sound insulation between dwellings.

### Typical errors in design and workmanship

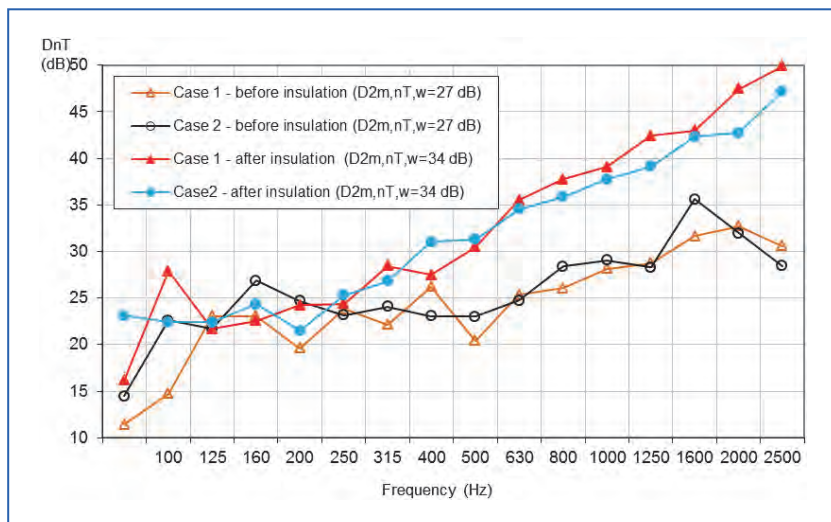
The acoustic performance of buildings can be highly compromised by design aspects and by the execution of constructive details. Examples of the most common design and workmanship errors for airborne sound insulation and impact sound are listed below.

#### Design errors

- design provides for a single ventilation duct for several floors (usually in WC without windows);
- continuous floor without floating floor and continuous façade between apartments (the inner leaf of the façade bridges both leaves of the separating wall);
- roller shutters designed with low acoustic performance boxes embedded in the wall;
- tendency to have large glazed areas;
- locating noisy activities on the ground floor of residential buildings;
- locating the elevator shaft close to bedrooms;
- locating buildings in noisy areas; one of the current problems with external noise lies in flawed urban planning processes and having residential buildings located in noisy areas.



Two examples of the airborne sound insulation of façades before and after insulating the roller shutter box are presented in Figure 20.9 [3]. These roller shutter boxes are made of precast concrete without any type of acoustic or thermal insulation and are enclosed underneath by a wooden cover 8 mm thick. The sound insulation improvement was done by coating the interior of the box, as well as the cover, with agglomerated flexible polyurethane foam. The sound insulation of the wooden cover is increased with an additional layer of an elastomeric membrane.



**Figure 20.9.** Case studies: airborne sound insulation of façades before and after insulating the roller shutter box.

## Workmanship errors

Airborne sound insulation:

- gaps above masonry wall and lack of mortar in the vertical joints between the masonry bricks or blocks;
- very thin layers of render on walls;
- wall penetration such as by electrical boxes placed back-to-back, or ventilation ducts without attenuators;
- suspended ceilings: application of rigid suspension; lack of absorbing material in the plenum; application of built-in lighting, ventilation grills etc.

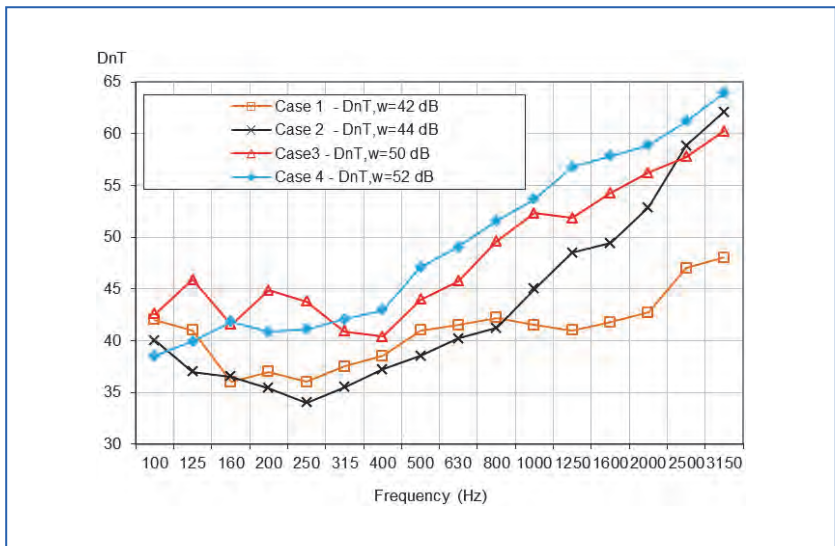
Impact sound:

- rigid bridges between floating screed and the concrete floor base or surrounding walls due to gaps in the resilient layer, or when the resilient layer is bypassed by fittings or pipes; rigid bridges between ceramic tiles and the doorstep;
- continuity of the floating screed (no expansion joint) between adjacent compartments on the same floor (usually when vertical lightweight partitions are installed, unusual in residential buildings);
- floating wood (or laminated) floor: use of very thin resilient layers, easily penetrated by sand and / or small stones, and not cleaned during the construction before the floating floor is laid.

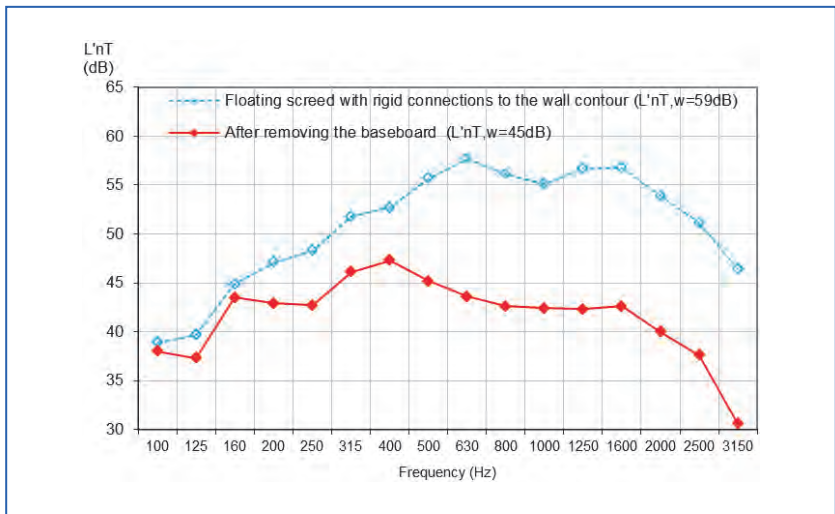
Examples of the above errors, including experimental results [3], are illustrated in the figures below.

Figure 20.10 shows some plots of airborne sound insulation between dwellings with a cavity wall partition. Case 1 refers to a common situation of a low insulation partition masonry wall, with gaps above and deficient rendering, and without insulating material in the cavity (the render is a sprayed plaster). In case 2, the wall cavity is rendered with sprayed plaster and the cavity has insulating material. Case 3 differs from case 2 in that the render is traditionally applied. Case 4 shows the results for a double wall without gaps above, with plaster applied correctly on both sides and on one inner side of the wall cavity, which also contains insulating material.

Figure 20.11 shows the impact sound transmission measured upward, before and after removing the baseboard. It illustrates the influence of rigid bridges between a floating screed and the surrounding walls [3]. The measurements were performed between a shop in the ground floor and a dwelling (bedroom) in the first floor. Initially, the tests were carried out having an apparent rigid connection between the floating screed and the baseboard, through the adhesive cement used to apply the ceramic tiles of the floor. Due to the poor results obtained, the baseboard was removed and the tests have been repeated. An improvement of 14 dB in terms of  $L'_{nT,w}$  was obtained. This type of problem occurs usually when the resilient layer is cut along the contour of the wall before the simultaneous application of the adhesive cement on the floor tiles and in the baseboard (be them ceramic or stone). To illustrate the influence of the continuity of the floating screed between adjacent compartments on the same floor, Figure 20.12 shows measurements for the impact sound transmission between compartments, with and without continuity [3].

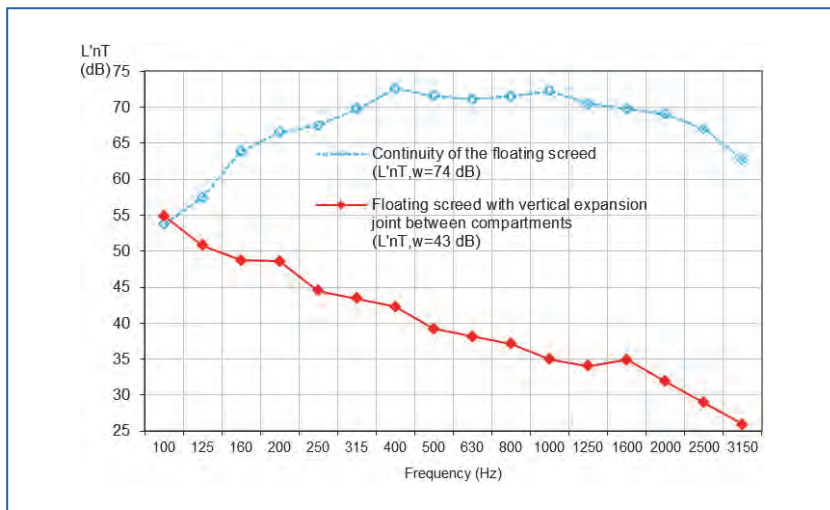


**Figure 20.10.** Case study: airborne sound insulation of partition walls. Case 1- sprayed plaster, empty cavity; Case 2 – sprayed plaster, insulated cavity; Case 3 – traditional plaster, insulated cavity; Case 4- traditional plaster on both sides and on one cavity face, plus insulated cavity.



**Figure 20.11.** Case study: Vertical measurements of impact sound transmission (upward), before and after removing the baseboard.





**Figure 20.12.** Case study: continuity of the floating screed.

### 20.1.3. Existing housing

#### Typical constructions found in existing stock and their acoustic performance

The number of dwellings in Portugal has increased significantly, especially since 1970. According to data from the 2001 Census, 63% of classic dwellings were built between 1971 and 2001, and there was also a large “production” of social housing from 1974 [4].

Before the end of the Second World War the constructive solutions of the walls of dwellings depended on the regional characteristics and climatic conditions of the areas where the buildings were built. Stone masonry predominated in areas where there was rock mass, to allow the construction of heavy, thick walls. In the rest of the country solid brick and sometimes “taipa” (rammed earth) was used. Traditional practices were progressively abandoned in the post-war period. Economic and social development fostered the rapid raising of the performance requirements of masonry. Thus the empirical knowledge acquired over the centuries has been replaced by the scientific knowledge required by the market. However, this evolution has not always created solutions that suit local conditions [5].

The 1940s saw the emergence of reinforced concrete as a structural solution, and masonry lost its structural characteristics to become a simple filling for



panels. This fact led it to be regarded as a non-specialty in construction, and so masonry in Portugal performed, and often still performs, poorly [5].

Brick masonry walls in Portugal eventually succeeded masonry stone walls. Although apparently there are no studies on this development, this is thought to be the sequence: single thick walls made of solid or perforated bricks; stone walls with an inner cladding of a wall of perforated bricks, possibly with an air cavity; double brick wall comprising one thick panel; double hollow brick wall composed of panels of medium or small thickness; double brick wall with thermal insulation totally or partially filling the air cavity (this is particularly for façade walls) [6].

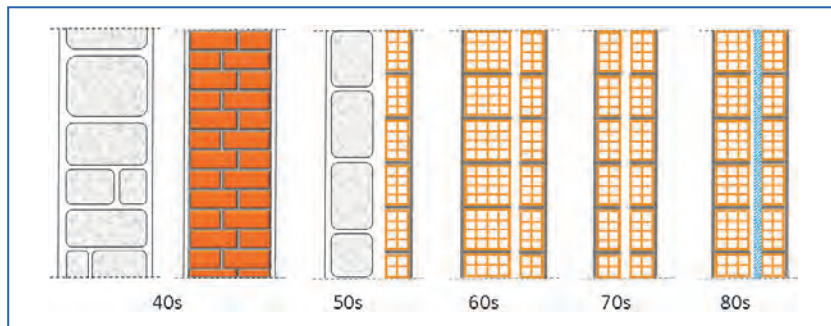
The evolution of typical walls, essentially façade walls, per period is displayed in Figure 20.13.

Nowadays, single façade walls are associated with innovative external thermal insulation solutions such as ETIC, or external wall cladding, and with new brick geometries and perforations capable of providing better mechanical and thermal performance.

Timber is the material used in most of the floors of buildings built before the 1950s. Since then, concrete has become widely used in floors, together with solid concrete slabs or pre-stressed concrete beams and ceramic blocks.

Figure 20.14 presents the statistical data on the current building stock, relative to the period of construction and main materials used.

There is no official data about the acoustic performance of the buildings over the years. The acoustic performance is found to have decreased when the solid walls have been replaced by hollow brick walls. Although acoustic regulations have existed since 1987, municipalities did not



**Figure 20.13.** Evolution of façade walls.

enforce them until 2000. Stricter requirements in terms of acoustic and thermal performance led to the inclusion of insulation in the double wall cavity. However, the thermal insulation chosen is sometimes unsatisfactory in terms of acoustic insulation. Table 20.1 shows approximate values of airborne sound insulation for different hollow brick walls in current use.

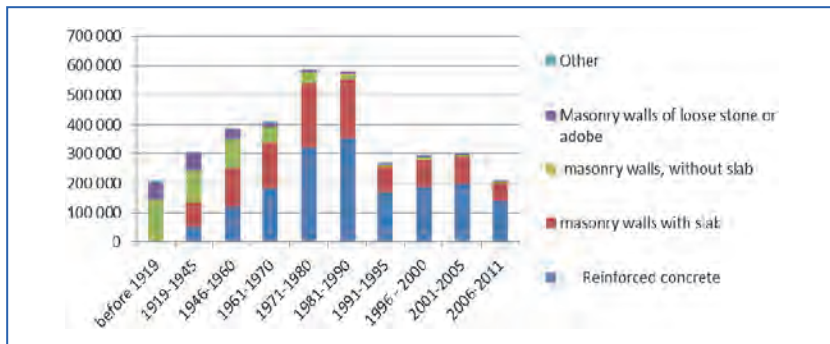


Figure 20.14. Existing building stock; period of construction and materials (2011 [1]).

Table 20.1. Examples of airborne sound insulation for walls [7].

Type of wall	$R_w$
Single wall of hollow brick 11 cm thick, rendered with mortar and joints filled with mortar	≈41 dB
Single wall of hollow brick 15 cm thick, rendered with mortar and joints filled with mortar	≈44 dB
Single wall of hollow brick 22 cm thick, rendered with mortar and joints filled with mortar	≈48 dB
Double wall rendered outside with mortar and joints filled with mortar, with two hollow brick panels 11 cm thick and the cavity partially filled with extruded polystyrene	≈50 dB
Double wall rendered outside with mortar and joints filled with mortar, with two hollow brick panels 11 cm thick and the cavity partially filled with mineral wool (70kg/m <sup>3</sup> )	≈52 dB
Double wall rendered outside with mortar and joints filled with mortar, with two hollow brick panels 11 cm and 15 cm thick and the cavity partially filled with extruded polystyrene	≈52 dB
Double wall rendered outside with mortar and joints filled with mortar, with two hollow brick panels 11 cm and 15 cm thick and the cavity partially filled with mineral wool (70kg/m <sup>3</sup> )	≈54 dB
Double wall rendered outside with mortar and joints filled with mortar, with two hollow brick panels 15 cm thick and the cavity filled with 4 cm of mineral wool (70kg/m <sup>3</sup> )	≈56 dB
Double wall rendered outside and on one inner face with mortar and joints filled with mortar, with two “acoustic” hollow brick panels with vertically oriented cavities 12.5 cm thick and the cavity filled with 4 cm of mineral wool (70kg/m <sup>3</sup> )	≈60 dB



## Period of building, description of the building and acoustic performances

In Portugal the available *in situ* acoustic measurements do not usually provide data on the construction elements. Some of the constructive technologies also coexist temporally. Thus, the periods of the buildings given here are indicative.

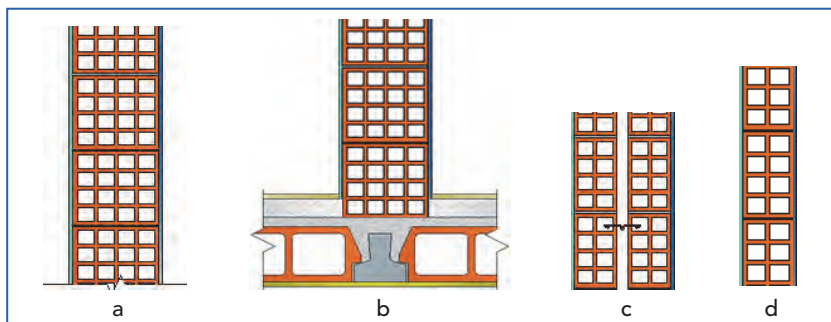
### Portuguese buildings built between 1970 and 1995

Approximately between 1970 and 1995, building's floors are mainly made of pre-stressed concrete beams and ceramic blocks (about 160 mm) with a layer of concrete (about 40 mm), covered by a mortar screed and coated with ceramic tiles or wood, without elastic layers, with a surface mass of about 330 kg/m<sup>2</sup>. The acoustic performance of this type of floor is about  $R_w = 47$  to 50 dB and  $L_{n,w} = 82$  to 87 dB (estimated from a set of *in situ* measurements of  $D_{n,w}$  and  $L'_{n,w}$  [8,9]).

Partition walls between dwellings are single walls made of hollow bricks about 20 cm thick and plastered on both sides with a layer about 10-15 mm thick, with a surface mass around 186 kg/m<sup>2</sup>. The inner walls typically consist of a single panel of hollow bricks 11 cm thick, rendered on both sides.

Façades are mainly double walls, with panels made of hollow bricks 11 cm thick, rendered on both sides, with an air cavity without insulation and windows with a 4-5 mm thick single pane and wooden frame.

The typical acoustic performance of the partition walls is around  $R_w = 46$  to 49 dB (estimated from a set of *in situ* measurements of  $D_{nT,w}$ ) while for façade walls the performance depends to a great extent on the quality of



**Figure 20.15.** Constructive elements in the period 1970 to 1995:  
a) Partition wall; b) Wall floor joint; c) Façade wall; d) Inner wall.



the windows, especially for single glazing. Examples of the constructive elements are displayed in figure 20.15.

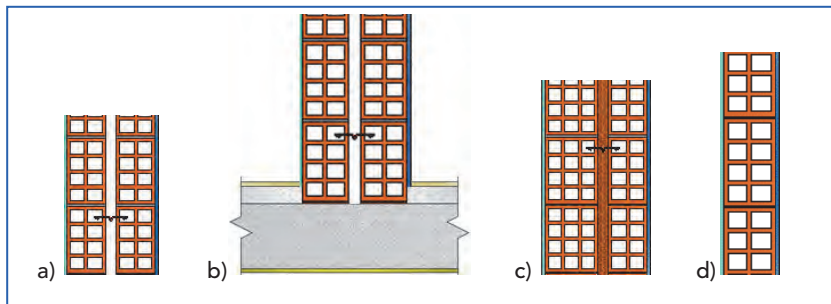
### Portuguese buildings built between 1995-2008

During this period solid concrete slabs (surface mass around  $480 \text{ kg/m}^2$ ) are combined with flat concrete slabs of hollow blocks (surface mass around  $294 \text{ kg/m}^2$ ) with total thickness between 250 and 300 mm. There is sometimes a floating floor. For solid concrete floors the typical values of acoustic performance are  $R_w = 55$  to  $58 \text{ dB}$  and  $L_{n,w} = 74$  to  $79 \text{ dB}$ , while for slabs made with hollow blocks they are  $R_w = 50$  to  $53 \text{ dB}$  and  $L_{n,w} = 80$  to  $85 \text{ dB}$  (estimated from a set of *in situ* measurements [8,9]).

Partition walls between dwellings are mainly double walls consisting of two panels of hollow bricks 11 cm thick, and with a plaster layer about 10-15 mm on both sides. The total surface mass is around  $220 \text{ kg/m}^2$  and there is no insulating material in the air cavity. The inner walls typically comprise a single panel of hollow bricks 11 cm thick, rendered on both sides.

Façades are mainly double walls of two panels made of hollow bricks, one 15 cm thick and the other 11 cm thick with both sides of the wall rendered and the air cavity filled with insulating material. Windows tend to have a double glass panel in wooden or metal frames, with thermal breaks in some cases.

In this case, airborne sound insulation of partition walls is approximately  $R_w = 48$  to  $51 \text{ dB}$ . For the façades, the performance is about  $R_w = 52 \text{ dB}$  for the double wall. The performance of the window depends largely on the type of the window (quality and opening system: casement or sliding) and the values can vary from  $R_w = 30 \text{ dB}$  to  $R_w = 40 \text{ dB}$  (laboratory measurements). Typical values are around  $30 \text{ dB}$ , however. Examples of the constructive elements are displayed in Figure 20.16.



**Figure 20.16.** Constructive elements in the period 1995-2008:  
a) Partition wall; b) Wall floor joint; c) Façade wall; d) Inner wall.



## Methods for improving sound insulation

The improvement of acoustic performance of existing buildings in Portugal is generally based on the actions below:

### Improvement of airborne sound insulation between dwellings

- application of wall linings with plasterboard and mineral wool.

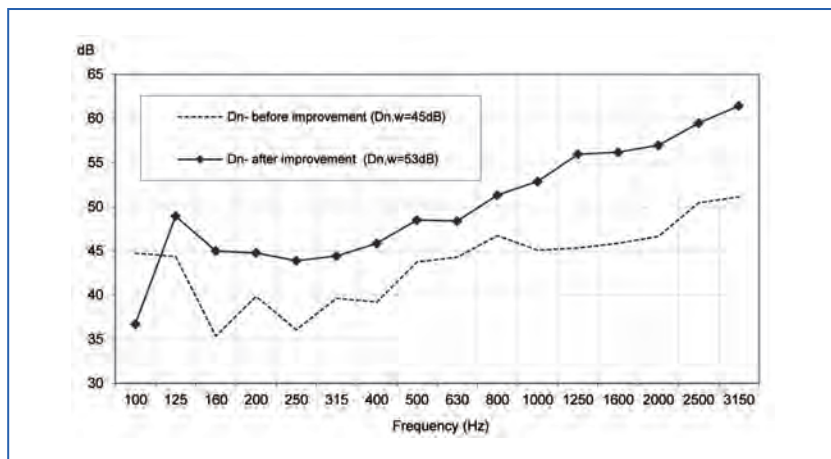
### Improvement of impact sound insulation of floors

- reinforcement of the floor by installing suspended ceilings below or by laying resilient coverings or floating floors.

### Improvement of sound insulation of façades

- window replacement or leakage sealing between frame and wall and/or frame and glazing, or installation of an additional window;
- improvement of acoustic performance of the shutter box by filling it with absorbing material.

An example of the application of wall linings with plasterboard and mineral wool is presented in Figure 20.17. In the example, a wall cavity was improved by applying two layers of plasterboard and rock wool panels (50-60 mm with density 40 kg/m<sup>3</sup>). The values of the  $D_n$  before and after improvement are presented in Figure 20.17.



**Figure 20.17.** Improvement of sound insulation of walls.

## 20.2. References

- [1] [www.ine.pt](http://www.ine.pt)
- [2] <http://pt.wikipedia.org/wiki/Portugal>
- [3] Diogo M. R. Mateus; Andreia C. S. Pereira, " Influence of small construction errors in the acoustic performance of buildings – typical examples" (in Portuguese), TECNIACUSTICA 2011, October, 26-28, Cáceres, Spain
- [4] Maria Fernanda da Silva Rodrigues, " Maintenance conditions of social housing" (in portuguese), PhD thesis, Universidade de Aveiro, 2008
- [5] Leonor Rosa Martins Catarino da Silva, "Technical / financial analysis of single panel external walls" (in portuguese), MSc thesis, IST, 2007
- [6] Sousa, Hipólito, "Improvement of the thermal and mechanical behaviour of masonry by acting on the geometry of the units. Expanded clay concrete blocks application" (in Portuguese), PhD thesis, Porto, FEUP, 1996
- [7] *Handbook of brick masonry* (in portuguese), Dias, Baio, ed. Centro Tecnológico da Cerâmica e do Vidro, 2<sup>nd</sup> ed, 2009
- [8] Diogo Mateus, "Acoustic behavior of floors (slabs) – lightweight solutions versus heavyweight solutions" (in portuguese), *Construção* magazine, n°. 45, September/October 2011, pp. 54-55
- [9] Diogo Mateus, "Acoustic behavior of walls - lightweight solutions versus heavyweight solutions" (in Portuguese), *Construção Magazine*, n°. 43, May/June 2011, pp. 40-41
- [10] Portugal, Laws, Decretos-Lei, 2008, Building Acoustics Code. Decreto-Lei 96/08, 9 June, 2008.



# Building acoustics throughout Europe

## Volume 2: Housing and construction types country by country

# 21

## Romania

Authors:

**Marta Cristina Zaharia<sup>1</sup>**  
**Mirel Florin Delia<sup>2</sup>**

<sup>1</sup> INCD URBAN-INCERC, Building Acoustics Laboratory, Bucharest, Romania  
e-mail: [marta\\_cristina\\_zaharia@yahoo.co.uk](mailto:marta_cristina_zaharia@yahoo.co.uk)

<sup>2</sup> UTCB, Bucharest, Romania  
e-mail: [florindelia@yahoo.com](mailto:florindelia@yahoo.com)





## CHAPTER

## 21

## Romania

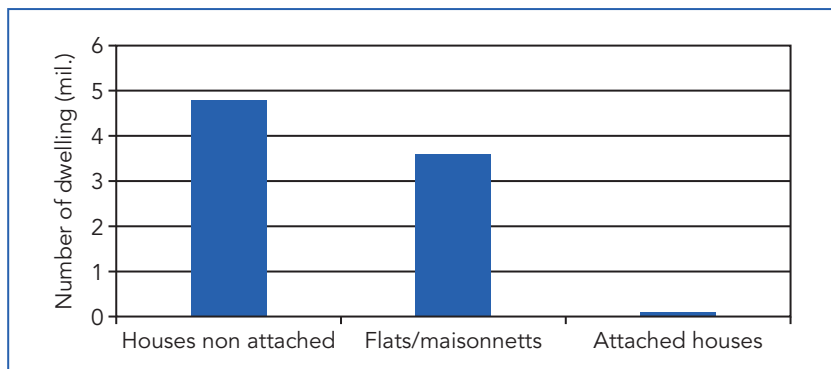
## 21.1. Overview of housing stock

## The quantities of housing stock and total population

**Romania** has an area of 238,400 square kilometers (92,000 sq mi) and a population of 18,631,386 (May 1, 2013). [7]

In 2011 the total number of dwellings was 8.5 million [8], (Figure 21.1); approximately 4.8m are detached houses, 3.6m are flats / maisonnettes and 0.1m are semi-detached/terraced houses.

Examples of building typology by size and construction over a range of periods are presented in following pictures (Figure 21.2 and Figure 21.3).



**Figure 21.1.** Number of dwellings types in Romania, in 2011 [8].



**Figure 21.2.** Apartment block: a) 1950-70s; b) 1970-80s; c) 1990s.

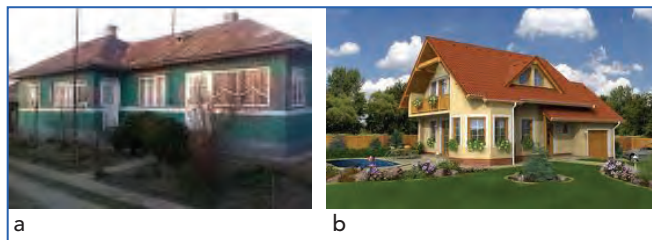


Figure 21.3. Attached houses: a) 1940-80s; b) 1990s.

### The most populated cities

The most populated three cities in Romania are: Bucharest (1.95m), Cluj-Napoca (0.31m) and Timisoara (0.30m) [7].

### Proportion of apartments, terraced (row) and detached houses

The percentage of dwellings by housing type in Romania, is indicated in Figure 21.4 (55% of the dwellings are detached houses, 40% are flats / maisonnettes and 5% are in semi-detached/terraced houses).

In Romania, the number of dwellings by years, in percentage, is indicated in Figure 21.5, [8].

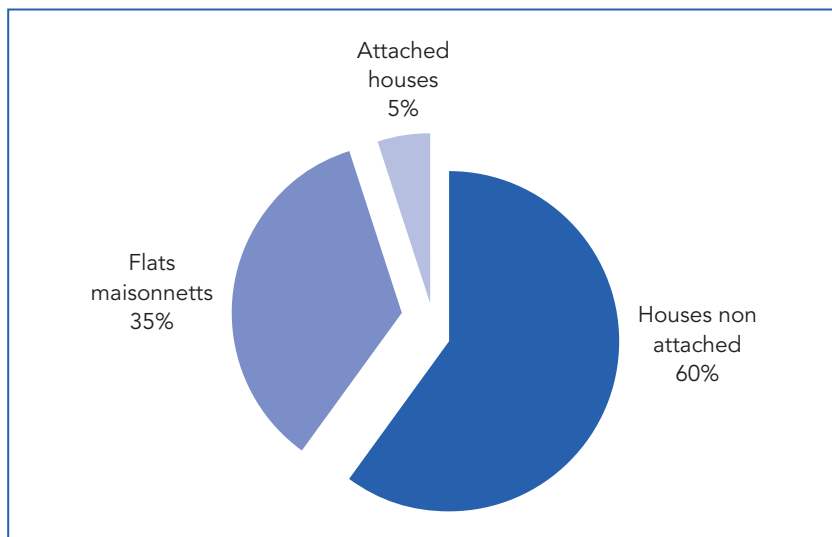
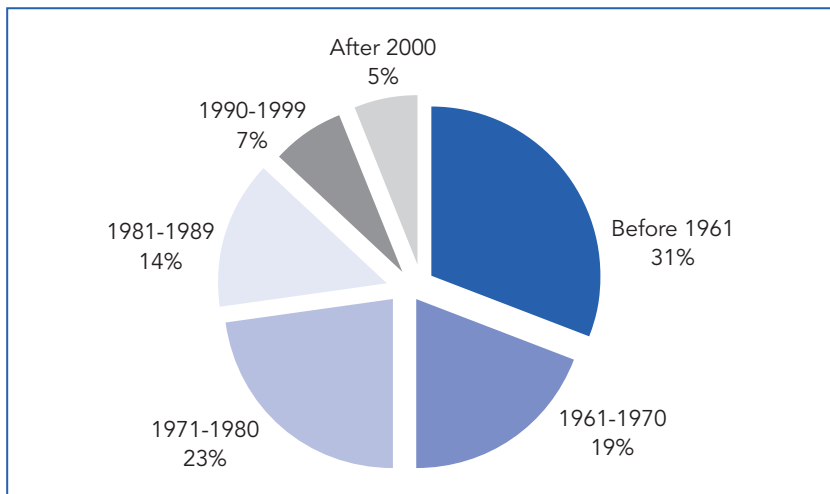


Figure 21.4. Dwelling types in Romania, 2011 [9].



**Figure 21.5.** Number of dwellings / years [9].

In Romania, the types of the structure / technical solutions can be conveniently divided into three periods [8]:

- before the 1961 years (31%);
- between 1960-1990 (53%);
- after the 1990 years (16%);

The relative heights of residential developments are shown below in Figure 21.6, as the total number of dwellings in buildings with various numbers of storeys, or levels.

- Ground Floor and Ground Floor plus one upper level (0.1%);
- G+4L (62.8%);
- G+8...10L (26.3%)
- others (10.8%).

The proportions of structural building materials are indicated in Figure 21.7:

- masonry brick / stone (38%);
- reinforced concrete (35%);
- wood (6%);
- others materials (21%).

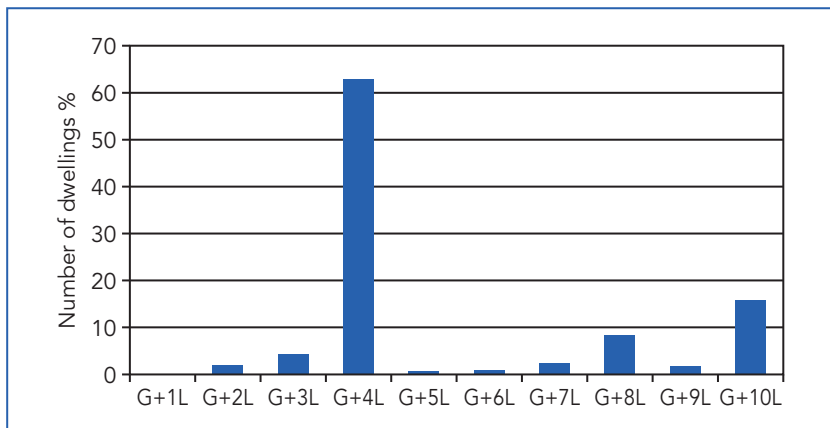


Figure 21.6. Number of dwellings / number of levels [9].

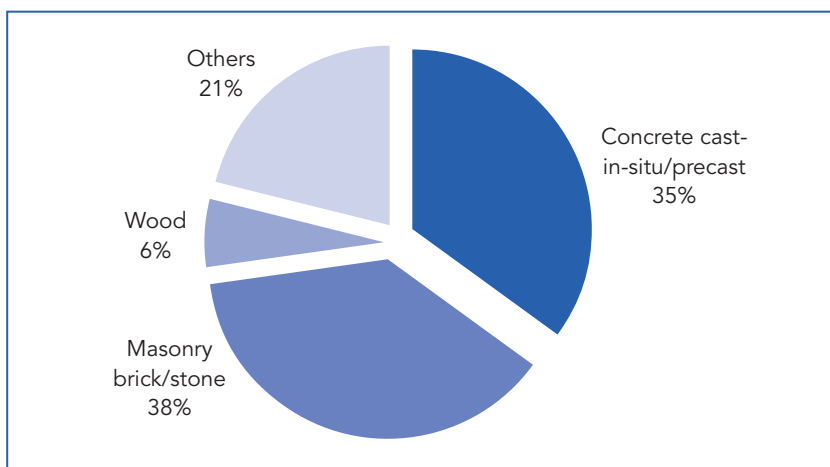


Figure 21.7. The materials used for structural buildings, Romania 2011 [9].

## 21.2. New build housing constructions

### Overview of housing stock

Since 2000 new build housing has added about 40,000...60,000/year (Figure 21.8).

Between 2005 and 2010, the average living area, increased from 38m<sup>2</sup> to 38.85m<sup>2</sup> (Figure 21.9).

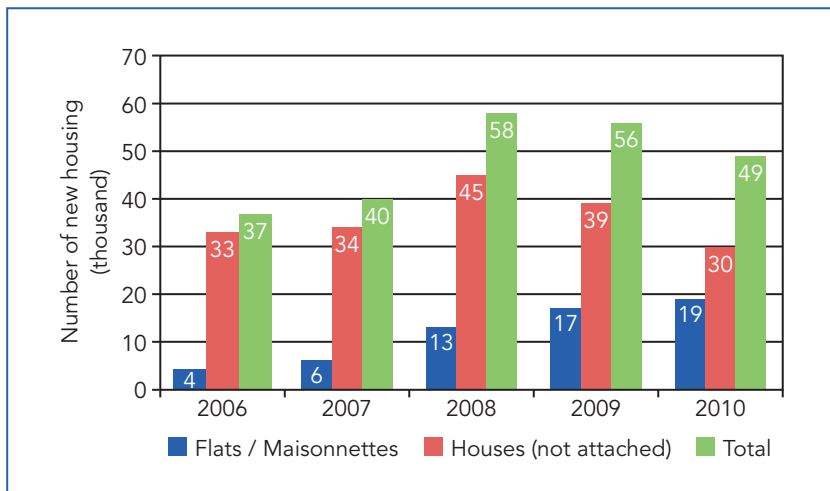


Figure 21.8. The number of new housing / year, Romania 2006-2010 [9].

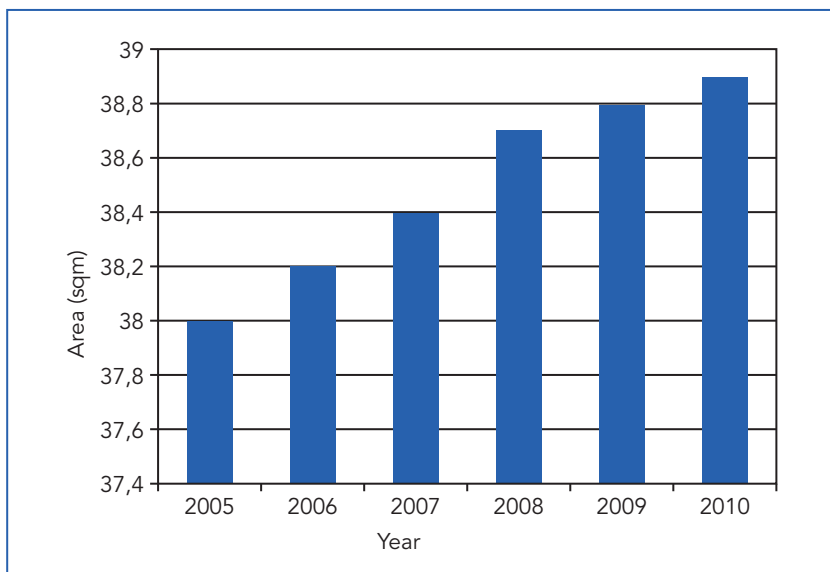


Figure 21.9. The home area / living area (m<sup>2</sup>), Romania, 2005-2010 [9].

The current distribution of new build housing in urban areas is 54.4% and rural areas is 45.6% (Figure 21.10).

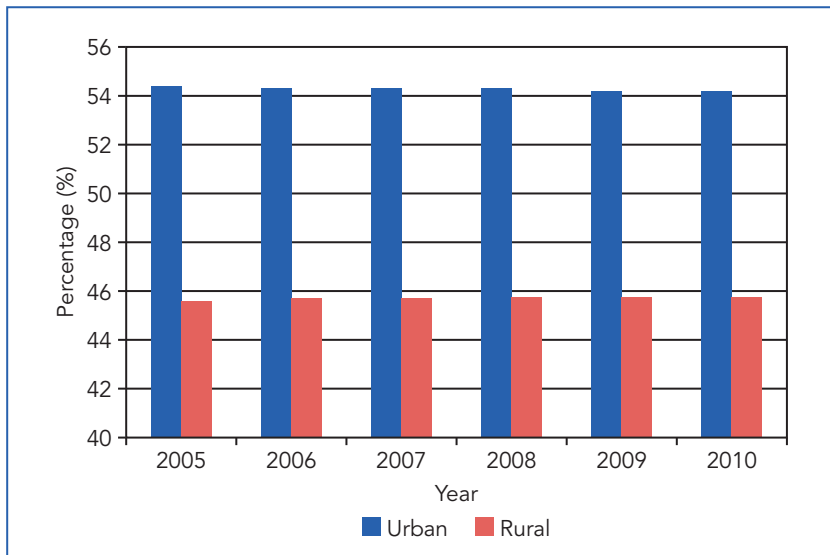


Figure 21.10. The type of housing / rural or urban area, Romania, 2005-2010 [9].

Property types are now mostly private (98.2%) with a small percentage state owned (1.5%) (Figure 21.11).

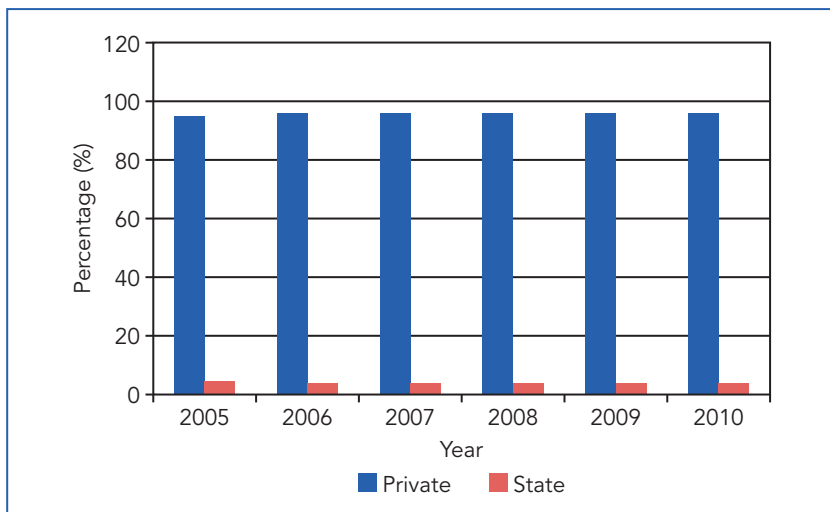


Figure 21.11. The type of property: private or state, Romania, 2005-2010 [9].



plasterboard Rigips/Knauf, 50 mm mineral wool, 26/51 mm air, 12 mm gypsum plasterboard Rigips/Knauf.

**Doors:** wood panel.

**Windows:** PVC argon filled double glazed units (low-e treatment)

### *21.2.1.3. Typical errors in design and workmanship*

**Inner wall** (75/125mm masonry brick) - rigid contact between wall and slab above.

**Floors** - Acoustic leak at gap between ceramic tiles, plinth and walls.

**Doors** - Missing door seals.

### *21.2.2. Apartments/flats*

Type: High buildings.

Period: 1990 – present.

Nr. of levels: Basement, Ground Floor and 8 to 12 upper storeys.

#### *21.2.2.1. Heavy typical constructions*

##### **Structural:**

- frame or dual system: reinforced concrete cast-in-situ, walls (300-350mm thickness), columns, beams;
- slab: reinforced concrete cast-in-situ 130-150mm thickness;
- rigid junction.

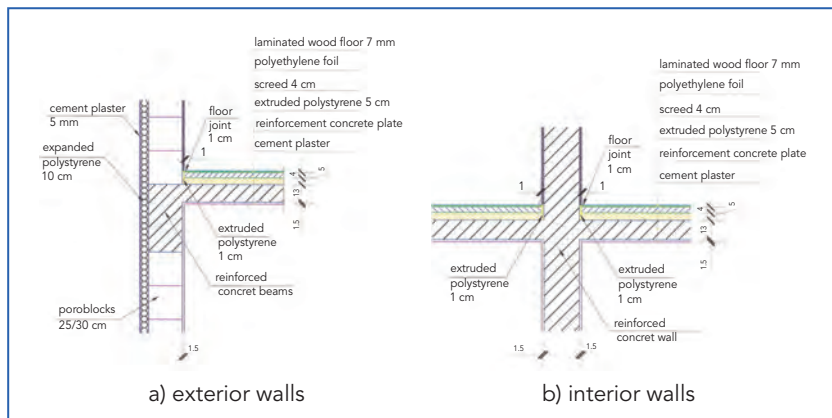
**Exterior walls:** 250-300mm perforated ceramic blocks + 100mm expanded polystyrene + 5 mm plaster.

##### **Floors:**

- warm: wood parquet with acoustic layer (screed + 50mm extruded polystyrene) or laminated wood floor with acoustic layer (4-8 mm expanded polyethylene, mineral wool);
- cold: ceramic tile with acoustic layer (screed + rubber plate);

**Ceiling:** 15mm cement plaster or resilient suspended ceiling (18 mm gypsum plates).





**Figure 21.13.** Example of the rigid contact between the walls and the slabs, high buildings.

### 21.2.2.2. Lightweight typical constructions

**Inner walls:** 75/125 mm masonry brick with 15 mm cement plaster on both sides, or 100/125 mm sandwich wall structure made from: 12 mm gypsum plasterboard Rigips/Knauf, 50 mm mineral wool, 26/51 mm air, 12 mm gypsum plasterboard Rigips/Knauf.

**Doors:** wood panel.

**Windows:** PVC argon filled double glazed units (low-e treatment)

### 21.2.2.3. Typical errors in design and workmanship

**Inner wall** (Rigips or Knauf types) - the wall are not fixed upper into the structural element (Figure 21.14).

**Doors** - Missing door seals.

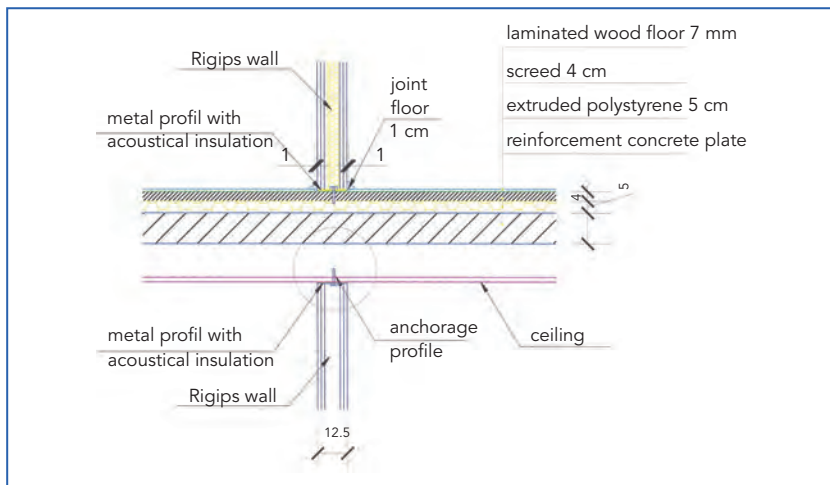
**Floors** - Acoustic leak at gap between ceramic tiles, plinth and walls.

**Light walls** - Missing perimeter rubber tape between metal profile and walls.

## 21.3. Existing housing

In Romania there are approximately 8,500,000 dwellings [8]:

- around 3,500,000 are apartments, in blocks of B+G+2to4L or B+G+8-12L; reinforced concrete, precast panel; approx. 80% of the buildings were made during the period 1970-1990;



**Figure 21.14.** Example of the typical errors for inner walls - upper contact wall with light ceiling.

- around 4,500,000 are individual houses, G+1L, from masonry; approx. 70% from the buildings were made during the period 1960-1990;

### 21.3.1. Typical constructions found in existing stock

#### 21.3.1.1. High rise blocks

Period: 1970 – 1990.

Nr. of levels: B+G+8to12L.



**Figure 21.15.** Example of high rise apartment blocks, Romania, 1970-1990.



### 21.3.1.1.1. Heavy typical constructions

#### Structural:

- dual system: reinforced concrete cast-in-situ or precast walls (200-250mm thick).
- slab: 130mm thick, made of reinforced concrete precast panels
- rigid junction.

**Exterior walls:** 280mm thickness, made of reinforced concrete precast panels.

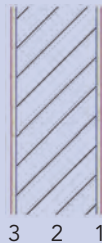
#### Floors:

- warm: linoleum, 40mm screed;
- cold: 40mm mosaic cast-in-situ.

**Ceiling:** 15mm cement plaster.

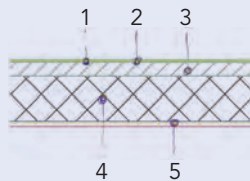
*Party wall description:* (Surface mass 660 kg/m<sup>2</sup>)

1. cement plaster 10mm thick;
2. reinforced concrete 250mm thick;
3. cement plaster 10mm thick;



*Floor description (up-down):* (Surface mass: 440 kg/m<sup>2</sup>)

1. PVC carpet;
2. adhesive layer;
3. screed 40mm thick;
4. reinforced concrete 130mm thick;
5. cement plaster 10mm thick;



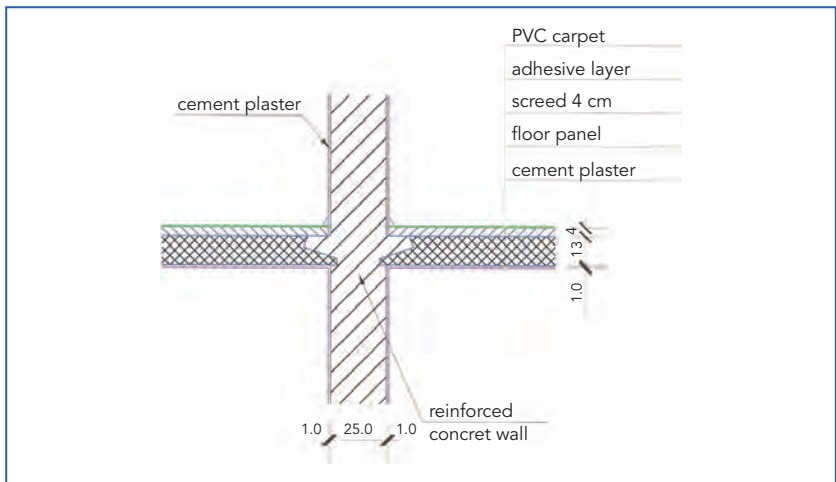


Figure 21.16. Typical details for joint between interior walls and slabs.

*Façade wall description (int.-ext):*  
 (Surface mass: 525 kg/m<sup>2</sup>)

1. cement plaster 10mm thick;
2. reinforced concrete 140mm thick;
3. expanded polystyrene 85mm thick;
4. reinforced concrete 55mm thick;
5. cement plaster 10mm thick;

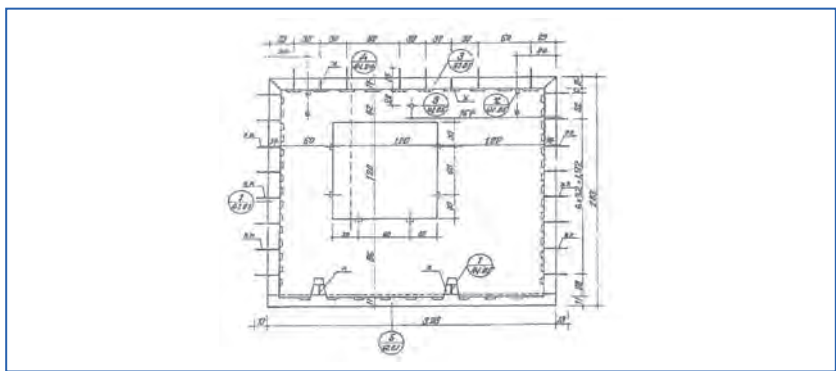


Figure 21.17. Typical solutions for connecting precast wall panels.

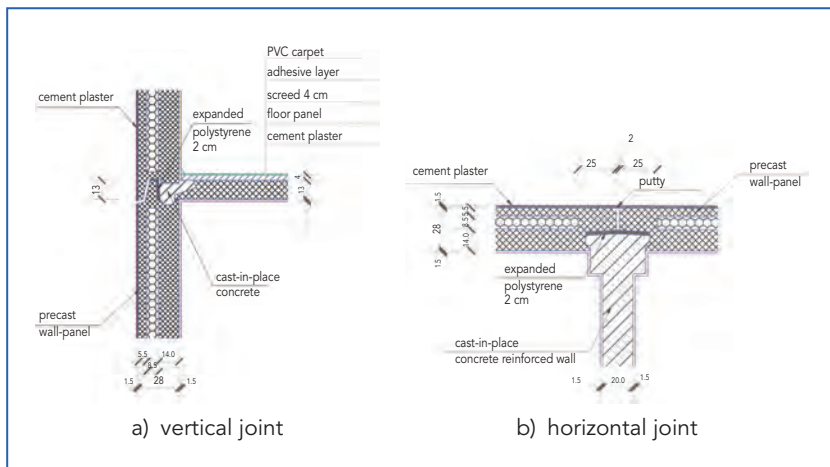


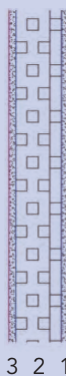
Figure 21.18. Typical details for joints between precast exterior wall panels and slabs.

### 21.3.1.1.2. Lightweight typical constructions

**Inner walls:** 10 cm thickness, made of cellular concrete masonry plates

*Inner wall description:* (Surface mass: 90 kg/m<sup>2</sup>)

1. cement plaster 15mm thick;
2. cellular concrete masonry plates 100mm thick;
3. cement plaster 15mm thick;



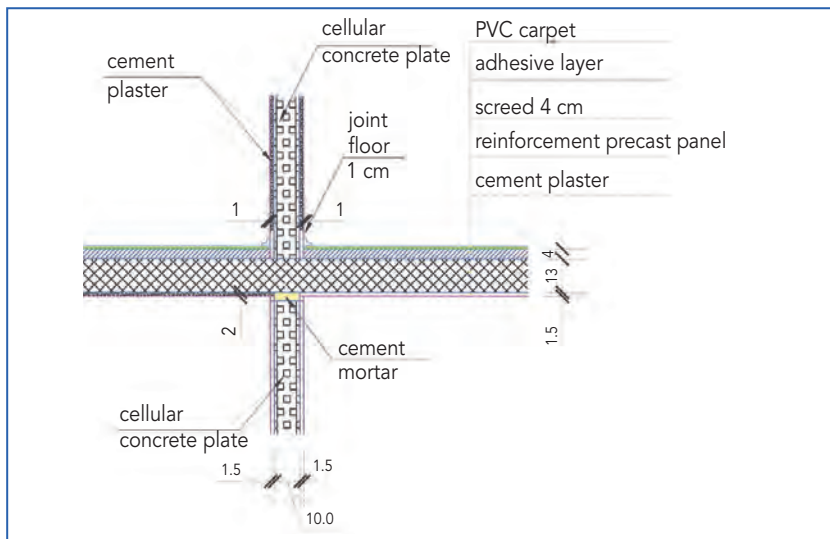


Figure 21.19. Typical details for joint between inner walls and slabs.

The in laboratory airborne sound insulation for an inner wall, 100mm cellular concrete masonry blocks is presented in Figure 21.20.

F (Hz)	100	125	160	200	250	315	400	500	630	800	1000	1250	1600	2000	2500	3150
R (dB)	29	32	30	29	28	31	34	32	32	33	37	39	41	42	45	46

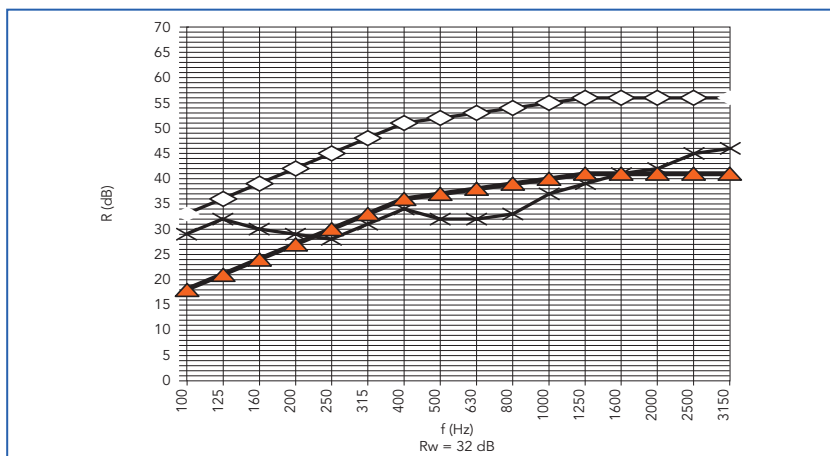


Figure 21.20. Airborne sound insulation, example from measurements of internal wall made from 100mm cellular concrete masonry blocks.



**Doors:** wood panel.

**Windows:** double glazed in wooden frames.

### 21.3.1.1.3. Typical errors in design and workmanship

**Rigid perimeter joint of inner wall** (100mm cellular concrete masonry plates or 75mm solid brick): missing replacement of acoustical insulation material, on the top of the inner wall with rigid material (cement mortar - specific protection for Romanian earthquakes).

**Rigid floor:** missing acoustical layer.

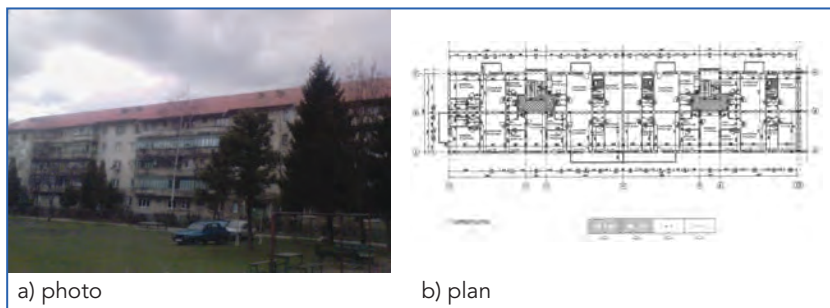
**Crossing pipes:** missing acoustic insulation around pipe.

**Rigid pipe mounts:** missing acoustic layer.

### 21.3.1.2. Medium high blocks

Period: 1950-1970.

Nr. of levels: B+G+2to4L.



**Figure 21.21.** Example of medium height apartment blocks, Romania, 1950-1970.

#### 21.3.1.2.1. Heavy typical constructions

**Structural:**

- structural walls: 250/375 mm thick brick;
- slab: 140/190mm thick, reinforced concrete precast planks with cavities or reinforced concrete cast-in-situ;
- rigid junction.

**Exterior walls:** 375mm masonry brick.



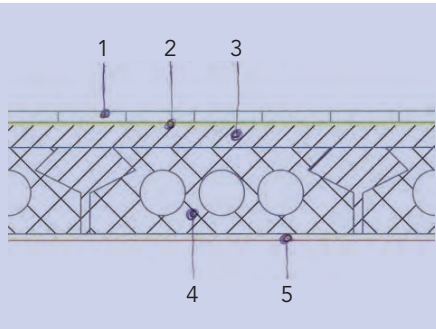
### Floors:

- warm: wood parquet without acoustic layer (40mm screed);
- cold: mosaic cast-in-situ 40mm thickness;

**Ceiling:** 15mm cement plaster.

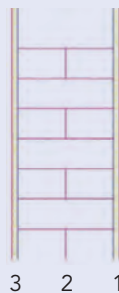
**Floor** (up-down): (Surface mass: 390 kg/m<sup>2</sup>)

1. wood parquet 12mm thick;
2. adhesive layer;
3. top plate 40mm thick;
4. precast hollow-core slab 190mm thickness;
5. cement plaster 10mm thickness;



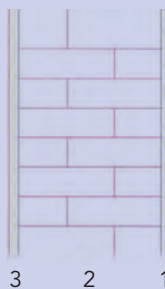
**Party walls**: (Surface mass: 500 kg/m<sup>2</sup>)

1. cement plaster 15mm thick;
2. solid ceramic masonry brick 24mm thick;
3. cement 15mm thick;



**Exterior walls** (int.-ext.):

1. cement plaster 15mm thick;
2. solid ceramic masonry brick 365mm thick;
3. cement plaster 25mm thick;





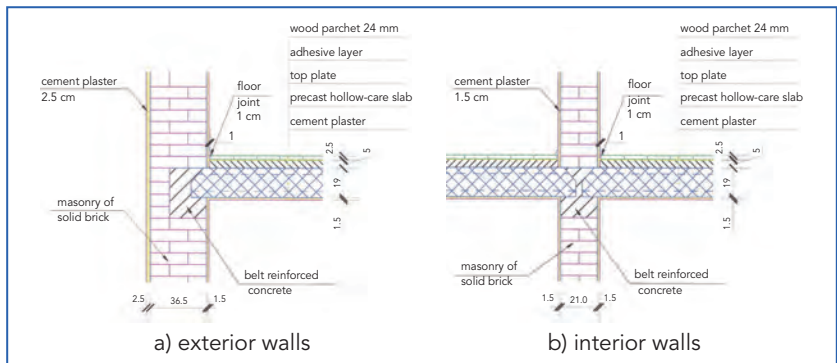


Figure 21.22. Typical details for a floor made of precast reinforced hollow concrete-core slabs and structural walls.

### 21.3.1.2.2. Lightweight typical constructions

#### Inner wall:

1. cement plaster 15mm thick;
2. solid ceramic masonry brick 68mm thick;
3. cement plaster 15mm thick;

3 2 1

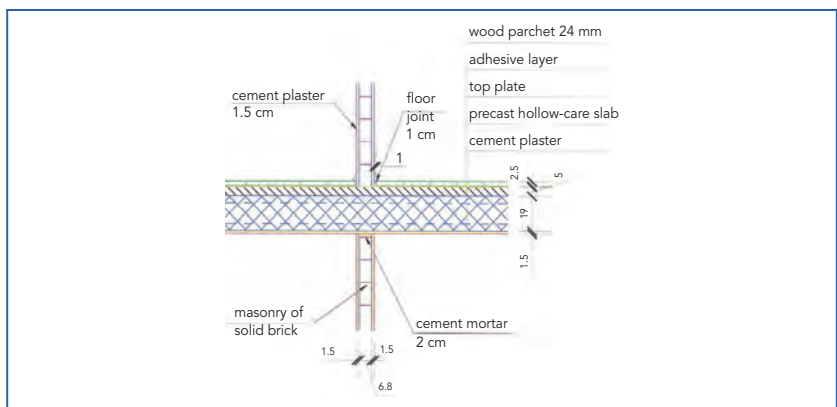


Figure 21.23. Typical details for a floor made of precast hollow reinforced concrete-core slabs and inner walls.

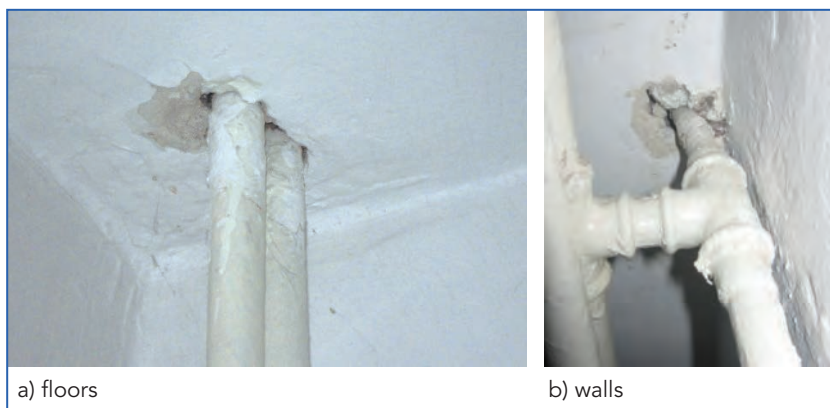
**Doors:** wood panel.

**Windows:** double glazed, wooden frame.

### 21.3.1.2.3. Typical errors in design and workmanship

**Walls** - missing acoustic layer between partition wall and structural elements  
- missing perimeter acoustic layers between screed and structural walls.

**Cross pipes** - acoustic leak between pipes and slabs or walls.



**Figure 21.21.** Typical errors for cross pipes.

### 21.3.1.3. Housings

Period: 1940 – 1980.

Number of storeys: G+1L.

#### 21.3.1.3.1. Heavy typical constructions

**Structural:**

- walls: 250 or 375mm masonry brick.
- slab: 100mm reinforced concrete cast-in-situ.
- rigid junctions.

**Exterior walls:** 375mm masonry brick.

**Floors:**

- warm: 28-48mm wood parquet.
- cold: 40mm cast-in-situ mosaic.

**Ceiling:** 15mm cement plaster.

### 21.3.1.3.2. Lightweight typical constructions

**Inner walls:** 75/125mm masonry brick.

**Doors:** wood panel.

**Windows:** double glazed, wooden frame.

### 21.3.1.3.3. Typical errors in design and workmanship

**Inner wall** - poorly finished slab junction.

#### Floors

- warm: missing acoustic layer.
- cold: rigid contact between mosaic and walls.

## 21.4. Legislation

*Period: 80s – 90s legislation (expired part of it, which is with the notation of the descriptors):*

Regulation: STAS 6156/86 [10]

	Airborne	Impact
Descriptor in field	$I'_a$ (airborne sound insulation index)	$I'_i$ (impact sound insulation index)
Frequency range	100-3150	100-3150
Value between apartments	$\geq 51$ dBA	$\leq 59$ dBA

*Current legislation:* Regulation: C125-2013 Normative concerning building acoustics and urban areas acoustics - Part 3 and Part 4 [10]

	Airborne horizontal $\leftrightarrow$	Airborne Vertical $\updownarrow$	Impact $\updownarrow$
Descriptor in field	$R'_w$	$R'_w$	$L'_{n,w}$
Frequency range	100-3150	100-3150	100-3150
Value between apartments	$\geq 51$ dB	$\geq 51$ dB	$\leq 62$ dB
Value between apartments and stairs cases, common halls, other similar spaces	$\geq 51$ dB	$\geq 51$ dB	$\leq 58$ dB

## 21.5. References

- [1] <http://www.costtu0901.eu/>
- [2] [http://w3.cost.esf.org/index.php?id=240&action\\_number=TU0901](http://w3.cost.esf.org/index.php?id=240&action_number=TU0901)
- [3] <http://extranet.cstb.fr/sites/cost/ebook/Forms/AllItems.aspx>
- [4] Proceedings of Florence EAA-COST Symposium (14-12-2010)
- [5] Proceedings of Forum Acusticum 2011 (TU0901 structured session)
- [6] Proceedings of Euronoise 2012 (TU0901 structured session)
- [7] wikipedia Romania
- [8] Statistical Yearbook 2011, National Institute of statistics, [www.insse.ro/cms/files/Anuar%20statistic/15/15%20Activitatea%20intreprinderii\\_en.pdf](http://www.insse.ro/cms/files/Anuar%20statistic/15/15%20Activitatea%20intreprinderii_en.pdf)
- [9] Population and housing census-2002 final results. [www.insse.ro/cms/files/RPL2002INS/index3.htm](http://www.insse.ro/cms/files/RPL2002INS/index3.htm)
- [10] Regulatory framework concerning Acoustics in buildings and urban areas:  
C125-2013 - Normative concerning building acoustics and urban areas acoustics  
Part. III - Measures of protection against noise from inhabited buildings, social-cultural and administrative and technical (indicative C125/3-2013); Part. IV - Measures of protection against noise in urban areas (indicative C125/4-2013).  
STAS 6156-86 Acoustics in constructions. Protection against noise in civile and social-cultural constructions. Admissible limits and parameters for acoustics insulation.



# Building acoustics throughout Europe

## Volume 2: Housing and construction types country by country

# 22

## Serbia

Authors:

Miomir Mijić<sup>1</sup>

Ana Radivojević<sup>2</sup>

Dragana Šumarac Pavlović<sup>1</sup>

Draško Mašović<sup>1</sup>

Milica Jovanović Popović<sup>2</sup>

Dušan Ignjatović<sup>2</sup>

Aleksandar Rajčić<sup>2</sup>

<sup>1</sup> University of Belgrade, School of Electrical Engineering, Belgrade, Serbia  
e-mail: emijic@etf.rs

<sup>2</sup> University of Belgrade, School of Architecture, Belgrade, Serbia



## CHAPTER

## 22

## Serbia

## 22.1. Introduction

### *Population*

According to the results of the national census from 2011, Serbia then had 7,186,862 inhabitants [1]. Results from a previous national census, together with the results of the extensive field survey of housing stock organised in 2012. and 2013. [2] revealed that Serbian citizens live in 2,246,320 buildings in which there are 3,188,414 dwellings, and the total area of Serbian housing stock covers 289,687,720 m<sup>2</sup> (average 90 m<sup>2</sup> per dwelling).

### *The most populated cities*

The most populated cities are Belgrade, the capital of Serbia, with 1,659,440 inhabitants (about 1/4 of population in the country). All other settlements are much smaller. Among them, there are two larger cities: Novi sad with 341,625 and Niš with 260,237 inhabitants. There are also 11 cities in Serbia with population between 100,000 and 200,000 inhabitants.

## 22.2. Overview of housing stock

### *The history of housing construction in Serbia*

In the history of housing construction in Serbia the years after World War II were the most prosperous. Building in Serbia had its historical maximum between 1960 and 1980.

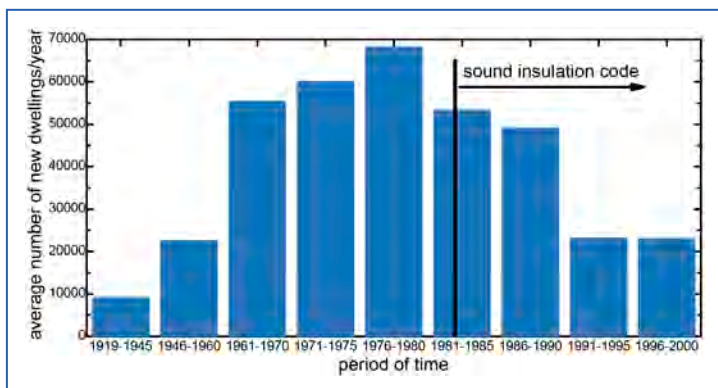
Regarding building types, single-family houses dominate in total number of buildings. Available data reveal that family housing in Serbia dominates, representing 60.77% of housing stock, vs. 39.23% of multifamily housing.

Multidwelling houses in existence today were built approximately in the last 100 years. Older houses are very rare. Important socio-political events such as wars (World War I and World War II, war in the region during the 1990's) brought both periods of stagnation in construction and also in some periods significant demolition. This was most evident during World War II due to repeated bombing of the largest cities.



Quantitative presentation of new dwellings production in the period after II World War up to the year 2000 is shown in Figure 22.1. In the diagram the average number of new dwellings built per year is shown. The historical moment of introducing the first code of sound insulation in building is also marked in the diagram (in the middle of the year 1982). Before then buildings were built without consideration of sound insulation between dwellings.

The production of new dwellings in last decade has been almost constant. Its quantitative presentation of new dwelling numbers per year is shown in Figure 22.2. The diagram covers period of five years between 2006. and 2010. It shows that contemporary production of new dwellings was nearly constant with approximately 18-20,000 new dwellings per year.

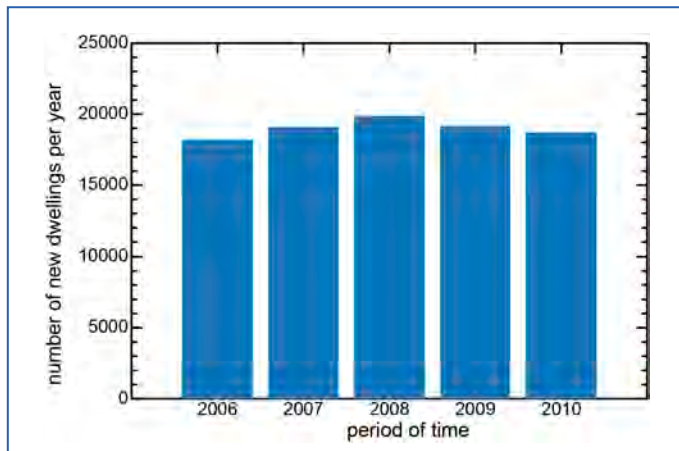


*Figure 22.1. Production of new dwellings per year (average number in marked periods of time).*

### *Structure of housing stock in Serbia*

Contemporary research established typology of single-family and multifamily housing with respect to its architectural and urban planning parameters [2,3]. Six building types were recognised:

- Family housing:
  1. Free standing single-family house
  2. Single-family house in a row
- Multi-family housing:
  3. Free standing residential building
  4. Residential building - lamella
  5. Residential building in a row
  6. High-rise residential building.



*Figure 22.2. Production of new dwellings per year in the period between 2006 and 2010.*

Some examples of Serbian housing are presented in Figure 22.3. All that houses in the Figure were built in last decades. Among multi-family houses buildings considered as lamellas are the most present.



*Figure 22.3. Some examples of houses in Serbia built in last decades.*



**Table 22.1.** Structure of Serbian residential housing stock referring to multidwelling buildings.

Type	 Free standing	 Lamela	 In a row	 High-rise	Total per period
<b>A</b> (< 1919)					
%	0.16%	0.11%	0.28%	–	0.55%
<b>B</b> (1919-1945)					
%	0.93%	0.30%	1.61%	–	2.84%
<b>C</b> (1946-1960)					
%	1.25%	2.38%	1.40%	0.11%	5.14%
<b>D</b> (1961-1970)					
%	5.67%	5.46%	1.96%	0.91%	14.00%
<b>E</b> (1971-1980)					
%	8.95%	15.38%	2.78%	2.13%	29.24%
<b>F</b> (1981-1990)					
%	9.56%	14.02%	2.99%	0.72%	27.29%
<b>G</b> (1991-2011)					
%	7.36%	9.16%	4.39%	–	20.91%
<b>total per building type</b>	<b>33.88%</b>	<b>46.81%</b>	<b>15.41%</b>	<b>3.87%</b>	<b>100%</b>

The chronological classification of housing stock is based on characteristic periods in evolution of the building constructions. The residential buildings in Serbia can be grouped into seven periods:

<b>A</b> until 1919	<b>C</b> 1946–1960	<b>E</b> 1971-1980	<b>G</b> 1991-2012
<b>B</b> 1919-1945	<b>D</b> 1961-1970	<b>F</b> 1981-1990	

Table 22.1 shows relevant multi-family building types from the Serbian residential building typology and percentage among the total floor area of multifamily housing for each type and each period of time.

### 22.3. Typical constructions in existing housing stock in Serbia

The structure of partitions between dwellings in existing housing stock reflects the historical period of construction. Besides regulatory sound insulation, evident in ex-Yugoslavia countries for the last 30 years and dictating partition design, several more factors had some influence on building constructions in Serbia, such as [2]:

- Introduction of prefabrication during the period of mass building construction started in the 1970's and lasted until 1990,
- Introduction of a building code concerned with seismic requirements,
- Introduction and development of relevant thermal regulation.

Estimation of seismic hazard at the territory of Serbia reveals that there is a probability of earthquake of up to 6 degrees of Mercalli scale. Thus seismic code requirements have very strong influence on building constructions. Concrete constructions became more widespread in architectural practice. As a result, concrete walls and floors are common in contemporary buildings today, and thus in most buildings there are concrete walls between dwellings.

Light constructions in multi-dwelling houses in Serbia today are not used at all (some rare exceptions are feasible). They can be found as interior partitions in public and business buildings (gypsum boards on metal frames), but only in last decade. This can be explained partially by existing standards for nonacoustic aspects of buildings, but also as some kind of tradition in civil engineering. Wooden constructions are extremely rare. In Serbia wood is not a widespread material for wall constructions, even in single-family houses. That is probably according to the same reasons as for

other types of light constructions. Wood is only used for roof construction, and only in single-family houses.

Mandatory thermal insulation between dwellings in Serbia was introduced at the end of the year 2012. Thus, in almost all existing housing stock the request for thermal insulation had no influence on design of walls between dwellings. Thus concrete walls without any additional insulating layer are common practice.

### *Structure of walls between dwellings*

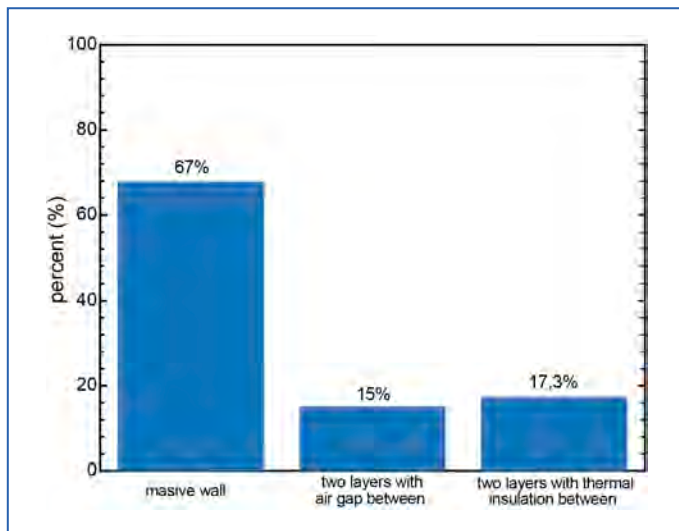
The use of certain types of walls between dwellings was a result of the common practice in a design process to combine structural requirements with other aspects of building quality. The representation of certain types of partition walls in the Serbian national typology of the housing stock is shown in Figure 22.4 (0,7% of walls are of some different types).

Due to the practice of dominant use of either massive masonry walls or a concrete panel system as the main load-bearing vertical structures of a house rather than a skeleton system, in most of the multi-dwelling buildings the structural walls were used as partitions between the dwellings. Solid brick was a dominant building material until the 1980's, and massive, load-bearing walls in earlier construction periods were in the most of the cases made as brick masonry walls. From the 1980's this practice has been substituted with either hollow clay block walls, or in most cases of today's building practice with reinforced concrete wall.

In some of the buildings there was also a practice of using double layer walls. Such constructions could have inner core either in a form of an air gap, or with the gap filled with a thermal insulation layer.

In about 15% of the existing buildings between dwellings there are multi-layer walls with an air-gap inside. Such walls were in use from the 1920's onwards, until the 1980's. The width of the air-gap varied from 4 cm to 25 cm, depending on non-acoustic factors in the building construction. Wider gaps can be found where the installations are placed between two dwellings. Their schematic pictures and structure are presented in the Table 22.2.

In about 17,3% of the existing buildings there are thermal insulating layers inside double layer walls, instead of an air-gap. This practice started from



*Figure 22.4. Representation of different types of walls between dwellings in the Serbian housing stock.*

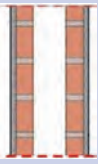
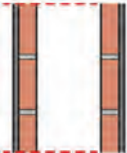
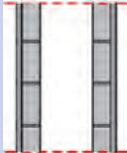
the 1970's onwards. Their schematic pictures and structure are presented in the Table 22.3.

### *Structure of floors between dwellings*


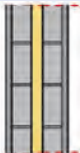

Floor structures between dwellings have more variations in types compared with walls. There are different types of concrete ribbed structures (30%), as well as concrete slab structures, which is the most used type of floor construction today (38%). From the time of the 1960's onwards there is also a significant use of semi-prefabricated hollow clay block floor constructions (30%), which are still in frequent use in family houses. The representation of different types of floor constructions in multi-family houses is shown in Figure 22.5. The main types of ribbed concrete slab floor structures are presented in Table 22.4, and semi-prefabricated hollow clay block structures in Table 22.5.

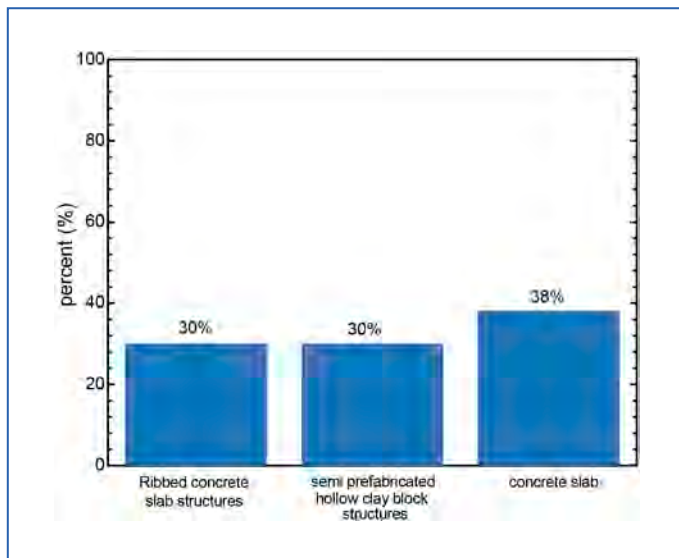
There are also some other types of floors, but at a very small percentage of the total housing stock, such as different types of prefabricated hollow concrete slab structures. In the oldest buildings there are also typical floor structures of that time, either with wooden rafters or vaulted structures, usually represented as a so-called Prussian vault.

**Table 22.2.** Types and structure of typical two layer partition walls between dwellings with an air-gap.

type of structure	Description
	<p>plaster 2 cm, brick wall 6,5 cm, air gap 4-12 cm, brick wall 6,5 cm, plaster 2 cm</p>
	<p>plaster 2 cm, breeze block 7 cm, air gap up to 25 cm, breeze block 7 cm, plaster 2 cm</p>
	<p>plaster 2 cm, hollow concrete block 7 cm, air gap up to 20 cm, hollow concrete block 7 cm, plaster 2 cm</p>

**Table 22.3.** Types and structure of typical two layer partition walls between dwellings with a thermal insulating core layer.

type of structure	Description
	<p>gypsum block 7 cm, woodwool slab 4 cm, hollow concrete block 7 cm, plaster 2 cm</p>
	<p>plaster 2 cm, hollow concrete block 7 cm, wood wool slab 4 cm, hollow concrete block 7 cm, plaster 2 cm</p>
	<p>plaster 2 cm, brick 12 cm, thermal insulation 2 cm, brick 6,5 cm, plaster 2 cm</p>



*Figure 22.5. Representation of different types of floors between dwellings in the Serbian housing stock.*


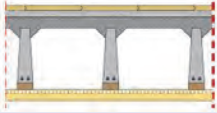

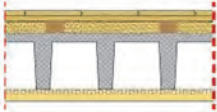
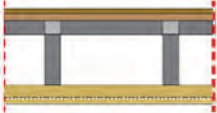
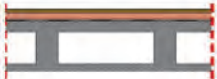
The typical constructions of semi prefabricated hollow clay block floor used in Serbia are presented in Table 22.5. These constructions can be found in multi-family houses in two variations: as a so-called TM floor construction which is the older version and one of the favourite floor structures of the period 1960-1990 when they were replaced in the most cases with improved version known as a the LMT floor construction.

## 22.4. Sound insulation of typical constructions between dwellings



### *Sound insulation of typical walls*

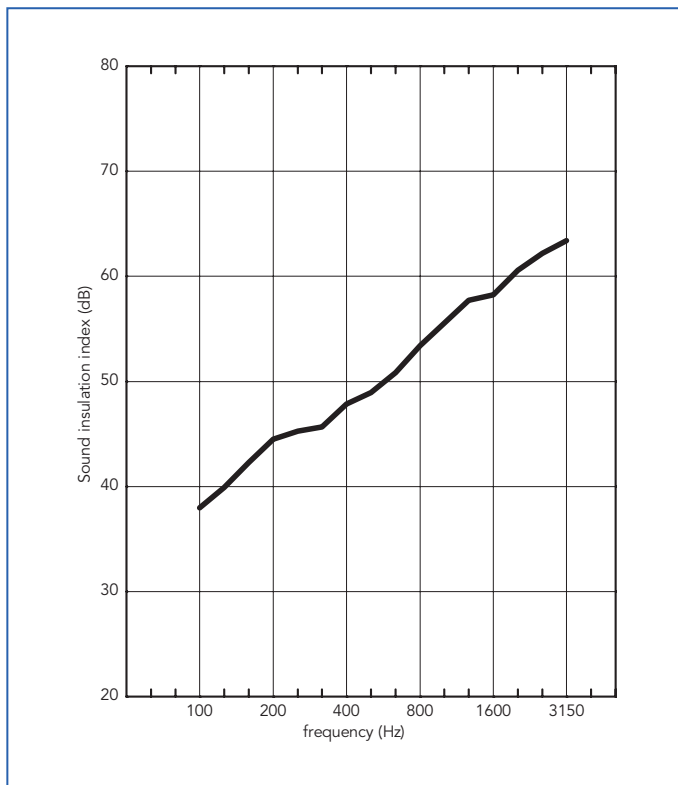
A 15-16 cm thick concrete slab is a common type of partition between dwellings today in high-rise buildings because it is also the structural wall. To estimate the effects on sound insulation in analysed buildings the results of sound insulation index measurement obtained for the walls with the same structure, in this case concrete slab 16 cm thick, are presented in Figure 22.5. A total of 18 walls of that type in different buildings were measured. The mean value is presented in the diagram below.

**Table 22.4.** Types and structure of typical ribbed concrete slab structures between dwellings.

type of structure	Description
	parquet 2,2 cm, wooden subfloor 2,5 cm, wooden sleepers 8/5 in sand bedding 5 cm, semi prefabricated <i>Herbst</i> ribbed concrete slab 30 cm + air gap, straw - plaster ceiling 5 cm
	parquet 2,2 cm glued, cement screed 3 cm, ribbed semi prefabricated concrete slab <i>Avramenko</i> 30 cm, straw - plaster ceiling 5 cm
	parquet 2,2 cm, wooden subfloor 2,5 cm, wooden sleepers 8/5 in sand bedding 5 cm, ribbed concrete slab 35 cm, straw - plaster ceiling 5 cm
	parquet 2,2 cm, wooden subfloor 2,5 cm, wooden sleepers 8/5 in sand bedding 5 cm, ribbed concrete slab 5+20 cm, straw - plaster ceiling 5 cm
	parquet 2,2 cm, wood cement screed 3 cm, ribbed concrete slab <i>Standard</i> 28 cm, straw-plaster ceiling 5 cm
	parquet 1,2 cm, wood fibre board base 3 cm, natron paper, IMS prefabricated concrete slab 22 cm

**Table 22.5.** Types of typical semi prefabricated hollow clay block structures between dwellings.

type of structure	Description
	parquet 2,2 cm, wood cement screed 2,5 cm (or parquet 1 cm, cement screed 3 cm, elastic layer 1-3 cm, ), TM slab with hollow clay block 20 cm, plaster 2 cm
	parquet 2,2 cm, cement screed 3 cm, elastic layer 2 cm, LMT slab with hollow clay block 20 cm, plaster 2 cm



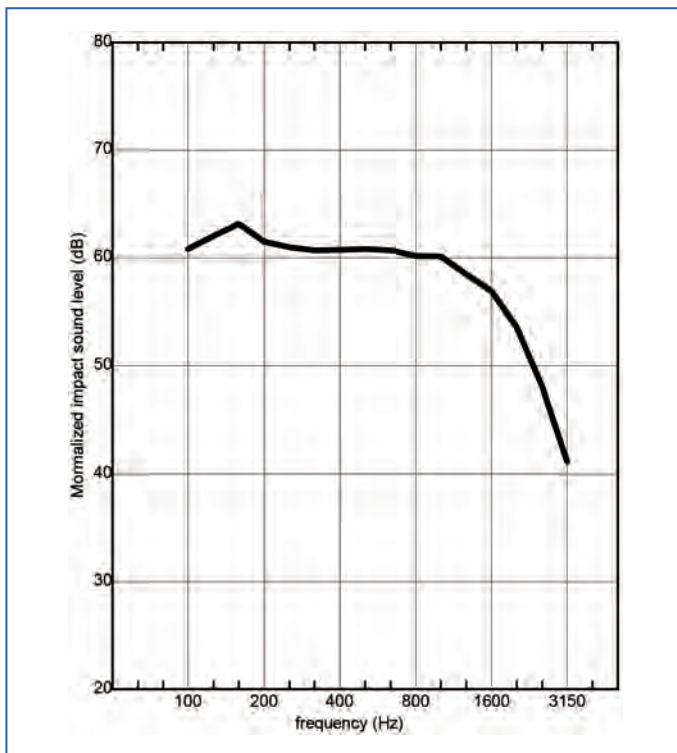
**Figure 22.6.** Mean value of sound reduction index for 16 cm concrete wall between dwellings measured in 18 buildings.

The diagram presented in Figure 22.6 as an average includes all influences in real buildings as flanking transmission, difference in rebar structure inside the concrete slab and installations breakthrough [3].

### *Normalised impact sound*

To estimate influence of those effects on sound insulation in analysed buildings the results obtained for the walls with the same structure, in this case concrete slab 16 cm thick, are presented in Figure 22.7. That type of wall is the most frequent as the partition between dwellings in high-rise buildings today, because it also the structural wall. Total of 16 walls of that type in different buildings were found and measured. The mean value is also presented in a diagram.





*Figure 22.7. Mean value of normalized impact sound level of 16 cm concrete slab with floating floor.*

## 22.5. Typical errors in design and in workmanship practice

Solid masonry partitions, as a widespread type in multidwelling buildings in Serbia, are less sensitive to potential incorrect approaches during building construction, compared to more complex structures. But there is still enough tolerance for some characteristic errors in design and in workmanship practice.

Most frequent errors in design stage with strong influence on the sound insulation inside the buildings are:

- Selection of partitions between dwellings by the data of laboratory measured sound insulation, without taking into account flanking transmission and type of junctions (calculation of sound insulation according to EN12354 is still not mandatory);

- Stairs rigidly connected to the side walls;
- Lack of floating floor in terraces and balconies above dwellings.
- Design of inappropriate material for resilient layer in floating floors;
- Lack of details concerned sound insulation in design of installations.

At the design stage a common error is the specification of incorrect materials as the elastic layer in floating floors. There is some misunderstanding among architects about appropriate materials for that purpose, which is difficult to overcome. Favoured materials often make the resonant frequency of floors too high and increase the impact sound level. It seems that there is a misguided verbal “tradition” between architects which propagates the same mistakes at a number of buildings all around the county. Such details in building design are not covered in university architecture courses, nor are good sources of reliable information available to them.

Most frequent workmanship errors with consequences on sound insulation are:

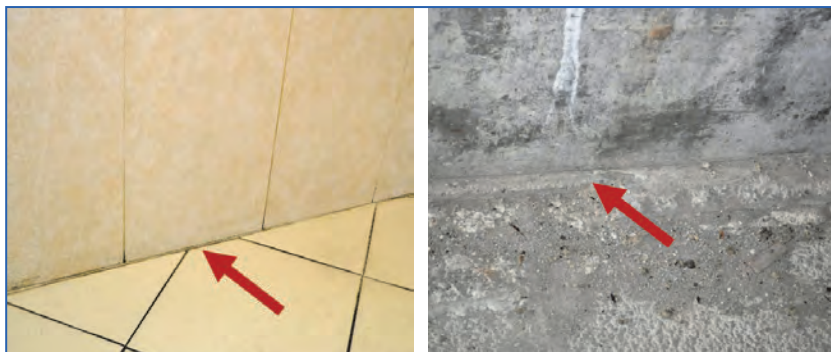
- Connection between floating floor and walls with acoustic bridge along perimeter; in nearly 100% of existing buildings floating floor in bathrooms exhibits this error (see Figure 22.4);
- Lack of mortar in vertical joints between bricks and clay blocks;
- Sound absorbing material not continuous in the cavity of cavity walls;
- Missing plaster on one side of the cavity in the cavity walls;
- Floor surface below the floating floor not perfectly flat, or not properly cleaned from brick pieces;
- Sometimes workers make special efforts to “improve” the floor and fill the gap around floating floor with mortar (see Figure 22.4);
- Unfiled holes and slits around HVAC installation.

Besides installations, the “weakest” part in buildings from the point of view of incorrect design and mistakes in workmanship practice are floating floors. In a number of analysed buildings two levels of errors in floating floors were detected: in the design stage and in their implementation.

In the practice main problems arise with appearance of parasitic sound bridges between floating layer and concrete slab or floating layer and walls around the room perimeter. The results of various measurements

proved that is hard to find floating floors with ceramic floor coverings without sound bridges around the perimeter. There is a lack of good practice in implantation of such details.

At Figure 22.8 two characteristic workmanship errors with floating floor are presented. An example from a bathroom (picture on left) reveals a rigid contact between ceramic tiles on the floor and on the wall. An additional example (picture on the right) shows the consequence of workers special efforts to “improve” the floor and fill the gap around floating floor with mortar.



**Figure 22.8.** Two examples of workmanship errors on floating floor: rigid contact between ceramic tiles on floor and wall (left), gap around a floating floor intentionally filled with mortar (right).

## 22.6. References

- [1] <http://popis2011.stat.rs/>
- [2] Jovanović Popović M. et al.: *Stambene zgrade Srbije/Residential Buildings in Serbia*. Belgrade: Faculty of Architecture, University of Belgrade, 2013.
- [3] M.Mijić, D.Šumarac-Pavlović, D.Todorović, A.Radivojević, “Sound insulation between dwellings in existing housing stock in Serbia”, *Euronoise*, Prag, 2012, Proceedings, 1254-1259
- [4] <http://www.costtu0901.eu/>



# Building acoustics throughout Europe

## Volume 2: Housing and construction types country by country

# 23

## Slovakia

Authors:

**Juraj Medved<sup>1</sup>**  
**Vojtech Chmelík<sup>2</sup>**  
**Andrea Vargová<sup>3</sup>**

Department of Building Construction  
Faculty of Civil Engineering  
STU Bratislava, Slovakia

<sup>1</sup> e-mail: [juraj.medved@stuba.sk](mailto:juraj.medved@stuba.sk)

<sup>2</sup> e-mail: [vojtech.chmelik@stuba.sk](mailto:vojtech.chmelik@stuba.sk)

<sup>3</sup> e-mail: [andrea.vargova@stuba.sk](mailto:andrea.vargova@stuba.sk)



## CHAPTER

## 23

## Slovakia

The permissible values of noise, infrasound, vibration and the requirements for objectification of noise, infrasound and vibration in the environment are established in Slovakia by the Ministry of Health of the Slovak Republic. Requirements for sound insulation are prescribed in Slovak acoustic standard STN 73 0532 and have been valid from 2000. From January 1<sup>st</sup> 2013 the revised standard STN 73 0532/2013 [1] is in force. The previous standard was mainly based on structures commonly used in that time and their acoustic characteristics. Since then, gradually the use of new structures began.

On May 21<sup>st</sup> 2011 Slovakia counted 905815 inhabited houses, 65,4% of them being built in the years 1946 – 1990. Table 23.1 shows the housing stock in Slovakia in 2011 and Table 23.2 shows the dwellings built in the years 1899 – 2011.

**Table 23.1.** Occupied dwelling stock in Slovakia on May 21<sup>st</sup> 2011 [2].

Type of dwelling	Number of dwellings	%
Flats in multi-family houses	764 100	43
Family houses (detached)	744 203	41,9
Other	268 395	15,1
<b>Total</b>	<b>1 776 698</b>	<b>100</b>

### 23.1. Residential building types and their constructions

Slovak standard defines a residential building as a building for housing consisting of four or more dwellings accessible from the common communication space with a common main entrance.

The residential buildings built in Slovakia during the last century can be divided in three periods:

1. 1918 – 1947,
2. 1948 – 1992,
3. 1993 – present.

**Table 23.2.** Number of dwellings built in multi-family and family houses in Slovakia [3,4]

Years built	Number of dwellings	Of it is		
		Multi-family	Family houses	Other
To 1899	57 728	12,1%	87,1%	0,8%
1900-1919	57 542	9,9%	89,6%	0,5%
1920-1945	162 429	14,2%	85,3%	0,5%
1946-1960	277 599	31,9%	67,6%	0,5%
1961-1970	330 896	50,5%	49,2%	0,3%
1971-1980	411 789	68,7%	31,0%	0,3%
1981-1983	97 905	76,7%	22,9%	0,4%
1984-1989	197 235	68,8%	30,6%	0,6%
1990-1992	61 891	58,3%	41,4%	0,3%
1993-2000	72 252	37,7%	61,6%	0,7%
2001-2005	63 960	39,3%	60,0%	0,7%
2006-2011	98 619	47,2%	52,0%	0,8%
<b>1899-2011</b>	<b>1 889 845</b>	<b>43,0%</b>	<b>56,5%</b>	<b>0,5%</b>

### 23.1.1. 1st period 1918 – 1947

#### 23.1.1.1. Building characterization

In the years 1918-1947 remarkable buildings of modern architecture having an international character were constructed. At that time the architectural design is affected by secession, rationalism, maturing eclecticism. The short period of cubism left marks in creating of state residential buildings. There are strict regulations for designing of building constructions but they are no acoustic requirements during this period. Due to this there were also no acoustical measurements performed.

Building constructions of residential buildings are:

- load bearing walls from stone, bricks, blocks (finishing - plaster or cladding); wooden ceiling or monolithic reinforced concrete ceiling,

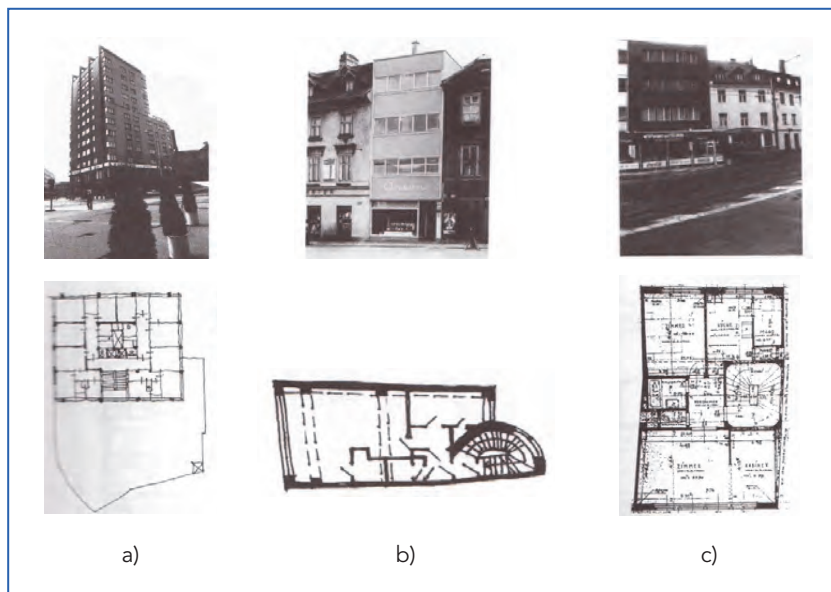


- reinforced concrete framed structure with infill construction from bricks and blocks; monolithic reinforced concrete ceiling,
- wooden constructions occurred occasionally (Northern, North-east Slovakia, family houses in countryside) – wall and ceiling structures (timber house, half-timber house)
- clay houses occurred occasionally (Southern Slovakia, family houses in countryside)

### 23.1.1.2. Sort characterization and photos

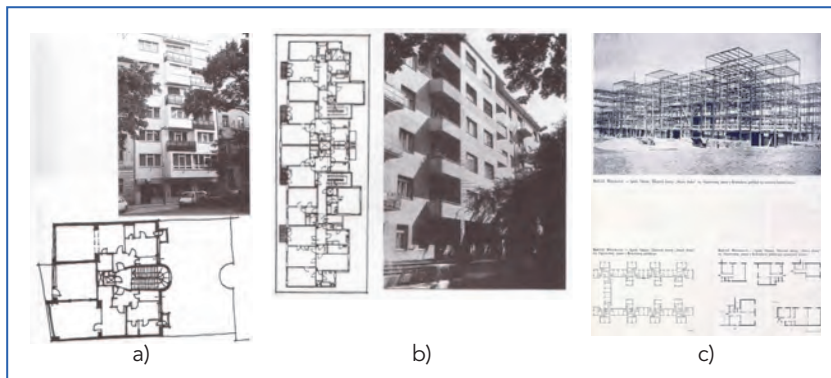
As typical building constructions in this period the frameworks and wall systems are presented.

- monolithic reinforced concrete frame structure (or steel frame), monolithic reinforced concrete ceiling, infill brick wall (Figure 23.1).



**Figure 23.1.** Residential houses in Bratislava [5].

- a) Residential house with commercial premises in the parterre (house Manderla; architects: Ludwig-Spitzer, 1933-35).
- b) Residential house with shops in the parterre (architect: D.Quastler, 1931-32, Bratislava).
- c) Residential house with shop in the parterre (architect: E.Steiner, 1936, Bratislava).



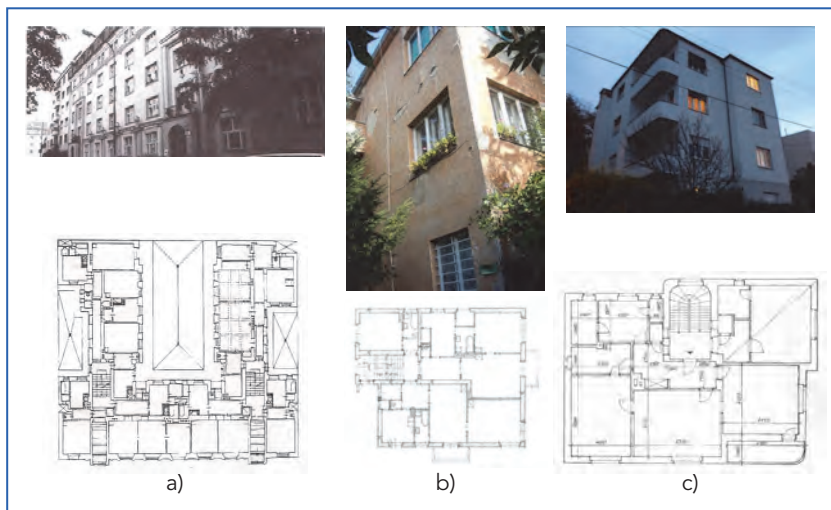
**Figure 23.2.** Residential houses in Bratislava [5,6].

a) Residential house (architect: B. Fuchs, 1935-36).

b) Residential house for rent (architect: J. Konrád, 1937, Bratislava).

c) Residential houses – used steel frame, (architects: Weinwurm - Vécsei, 1932-41, Bratislava).

- brick wall, monolithic reinforced concrete ceiling or wooden ceiling (Figure 23.3).



**Figure 23.3.** Residential houses in Bratislava .

a) Residential house (architect: J. Merganc, 1922-23) [6].

b) Residential house (1935).

c) Residential house (architect: J. Konrad, 1934).



23.1.1.3. Typical details (wall and ceiling construction)

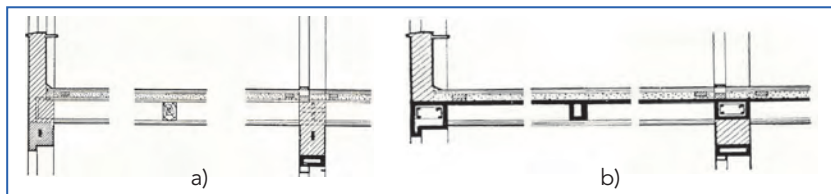


Figure 23.4. Connection of exterior brick masonry wall with a wooden ceiling (a) and reinforced concrete ceiling (b) [7].

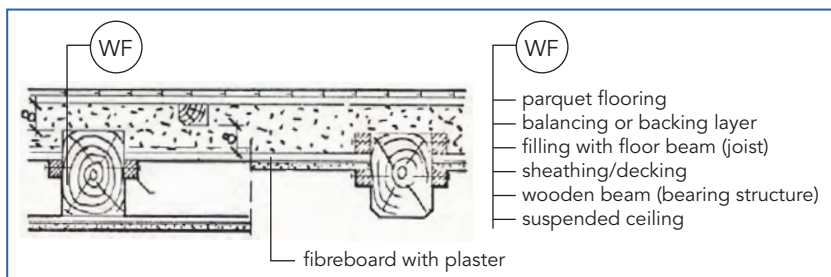


Figure 23.5. Composition of original wood flooring (WF) [7].

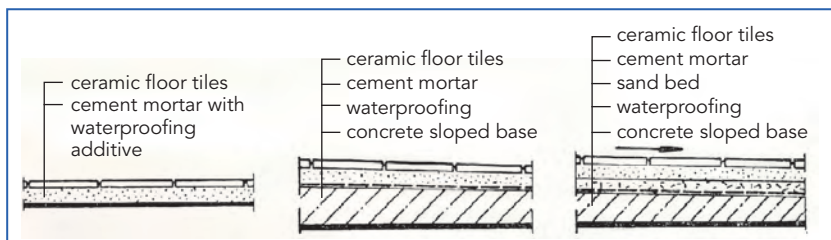


Figure 23.6. Ceramic floor tiles, floor structure [7].

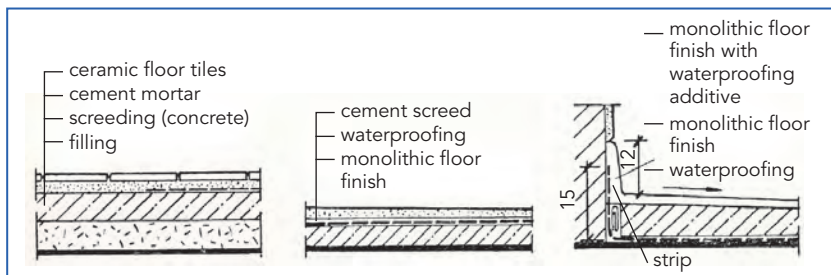
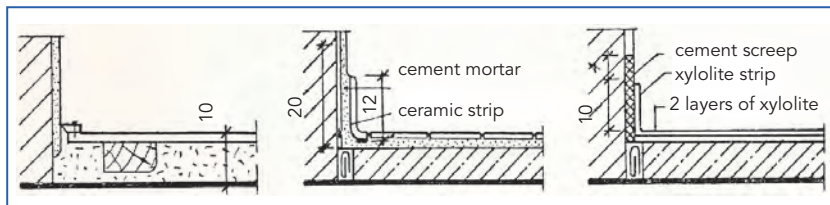


Figure 23.7. Floor structure - alternatives [7].



**Figure 23.8.** Wood floor.

**Figure 23.9.** Ceramic floor.

**Figure 23.10.** Xylolite floor – contact with a wall [7].

#### 23.1.1.4. Advantage from acoustic viewpoint

Urban planning and architectural work create an environment (external and indoor) in this period (1918-1947) which affect the acoustic comfort as following:

- Designing of inner courtyard and orientation of a majority of residential area toward inner courtyard where the traffic noise is negligible.
- Façade shaping as a mean to protect against traffic noise
- An optimal arrangement of building interior with regard to acoustic comfort.

In this period, buildings are designed and performed mainly from constructions with higher volume density and thus better acoustic properties of these constructions (partition wall and ceiling construction between neighbours) from airborne and impact sound insulation viewpoint are provided.

#### 23.1.1.5. Typical causes of acoustic discomfort

- If wall construction between apartments is a partition wall (with lower volume density) consisting of brickwork (thickness 100 – 150 mm) the acoustic properties of building constructions are not comply sufficiently with the current acoustic requirements.

### 23.1.2. 2<sup>nd</sup> period 1948 – 1992

#### 23.1.2.1. Building characterization

Most of the multifamily houses, around 85%, have been built in the years 1948 to 1992. These houses were mostly built by mass construction as prefabricated panel technology. The average floor area of these dwellings is 62,29 m<sup>2</sup>.



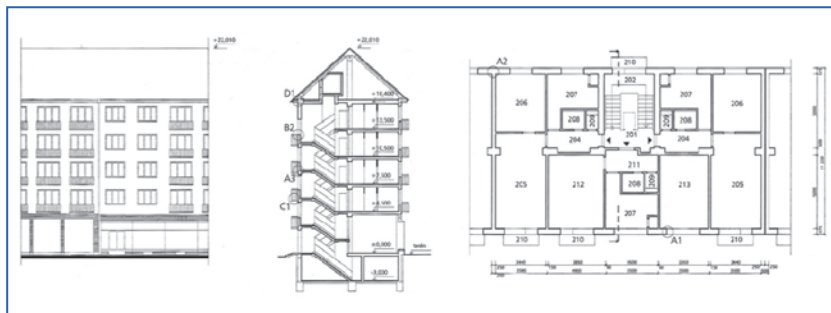
### 23.1.2.2. Sort characterization and photos

The quality of the structures dependent on the technical and technological developments and especially on details of the constructional frames. Table 23.3 shows structure types characterized according to the material type of curtain wall and its thickness. The individual systems can be classified by four groups:

1. Walled, cellular clay block;
2. Single layer prefabricated panel;
3. Single layer and multilayer prefabricated panel;
4. Single layer and multilayer prefabricated panel.

The following figures 23.9-23.12 show four typical types of multifamily houses.

Type T 01 B till T 03 B (see Figure 23.9) is the first type of multi-family house which was built by collective construction. This type was built as 3 to 6 storeys row house. The walls were made by brick; the thickness of internal load-bearing walls was 375 mm or 500 mm and curtain wall 365 mm. The ceiling slab was made as a reinforced concrete hollow panel of 215 mm thickness, placed on the curtain walls.



**Figure 23.9.** Multi-family house type T01B-T03B (brick), [9].

The most widespread system of multi-family construction was T06B. By this system around 40% of all realized dwellings were built in the years 1948 to 1992 and it was the first generation of using large-scale concrete panels. It was built as tower or row 4, 6, 8 or 12 storey house.

**Table 23.3.** Structure types of mass construction in Slovakia in years 1951 - 1992 [4]

Group	Construction system	Built period	Curtain wall	
			Material	Thickness
1	traditional brick		brick, block, aerated concrete blocks	300 - 450
	PV-2	1961-1969	porous concrete blocks	250
	T 11 - T 16	1951-1957	brick, block brick	450
	T 03 B	1957-1964	brick, block brick	365
2	G 57	1958-1963	slag pumiceous concrete panel	240
	BA	1955-1966	prestressed frame with ceramsite concrete	245
	LB (cast concrete)	1959-1964	ceramsite concrete panel	250
	MS 5, MS 11	1961-1971	flow-concrete	240
	T 06 B - NR	1970-1980	porous concrete panel	240
	- ZA	1963-1983	slag pumiceous ceramsite concrete panel	320
	- KE		ceramsite concrete panel	320
	- PO		expand-concrete panel	
	- BB		slag pumiceous concrete panel	
	- PP		flow-concrete	300
	- BA		ceramsite concrete panel	280
			porous concrete panel	250
	ZTB	1976-1981	ceramsite concrete panel	280
T 08 B	1960-1983	porous concrete panel	240	
3	BA-BC	1972-1983	concrete+50mm EPS+concrete	260
	B-70	1972-1984	concrete+60mm EPS+concrete	270
	BA NKS	1976-1980	concrete+70mm EPS+concrete	290
4	P 1.14 - 6.5RP	1975-1992	concrete+80mm	300
	P 1.14 - 7.5RP	1980-1992	EPS+concrete	
	P 1.15	1980-1992	porous concrete panel	300
	PS-82 - PP	1982-1992	concrete+80mm	300
	- ZA		EPS+concrete	
- BB				
- TT		porous concrete panel	300	



**Figure 23.10.** Multi-family house, row type T06B-KE (slag pumiceous ceramsite concrete panel), [4].

Figure 23.10 shows type T06B row house for region Kosice (KE). This type was built as tower house as well. The front and rear face curtain walls were made by slag pumiceous ceramsite concrete panel, 320 mm thick with density 1450 kg/m<sup>2</sup>. Gable walls were made by 140 mm thick reinforced concrete panel with 240 mm thick facing panel and 5 mm gap between them. The internal walls were made as reinforced concrete panels 140 mm thick and the ceiling slab was made as a reinforced concrete hollow panel 120 mm thick with compact concrete junction.

Another type of T06B system for region Nita (NR) shows Figure 23.11. It is a tower multi-family house. The front and rear face curtain walls were made by protruding, self-supporting aerated concrete panel, 240 mm thick. Gable walls were made by 140 mm thick reinforced concrete panel with 240 mm thick aerated concrete panel and 15 mm gap between them. The internal walls between rooms and dwellings were made by



140 mm thick aerated concrete panel and the ceiling slab was made as a reinforced concrete hollow panel 120 mm thick with compact concrete junction.

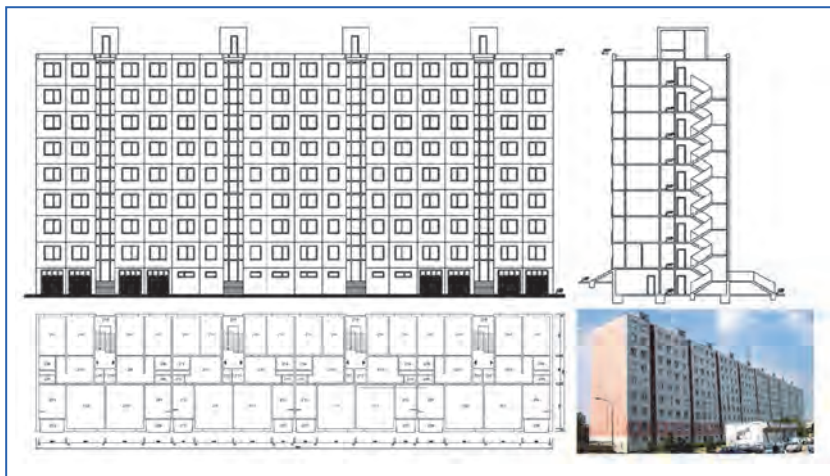


**Figure 23.11.** Multi-family house, tower type T06B-NR (porous concrete panel), [4].

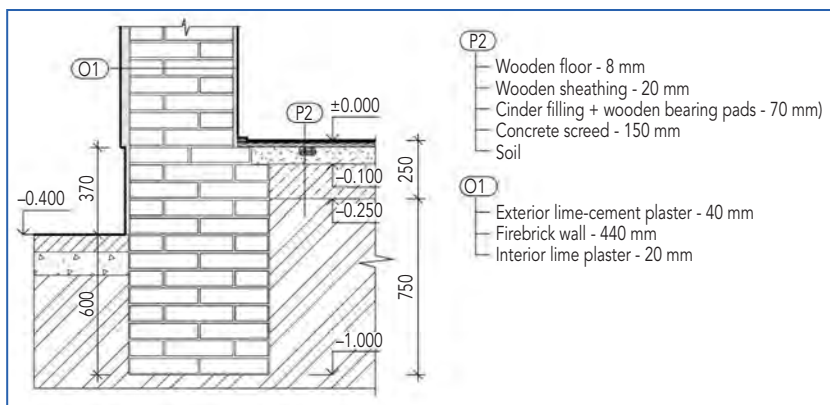
Another widespread system was P 1.14 and by this type was built more than 12% of all realised dwellings during 1948-1992. Row house types were built as 4 or 8 storeys and tower houses as 12 storeys. Figure 23.12 shows 8 storeys row multi-family house made by this type. The curtain walls were made as multilayer wall – inner support reinforced concrete panel 150 mm thick, thermal insulation of expanded polystyrene 80 mm thick and outer protruding concrete panel 70 mm thick. The inner walls and ceiling slabs were made as a reinforced concrete panel 150 mm thick.

### 23.1.2.3. Wall constructions

The typical most used wall construction up to 1980 for family houses was masonry made by firebrick bonded by cement mortar with thicknesses of construction 300-500 mm for curtain wall and 100-250 mm for partitions. Figure 23.13 shows ground detail of brickwork; same brick was used for basis under the wall.

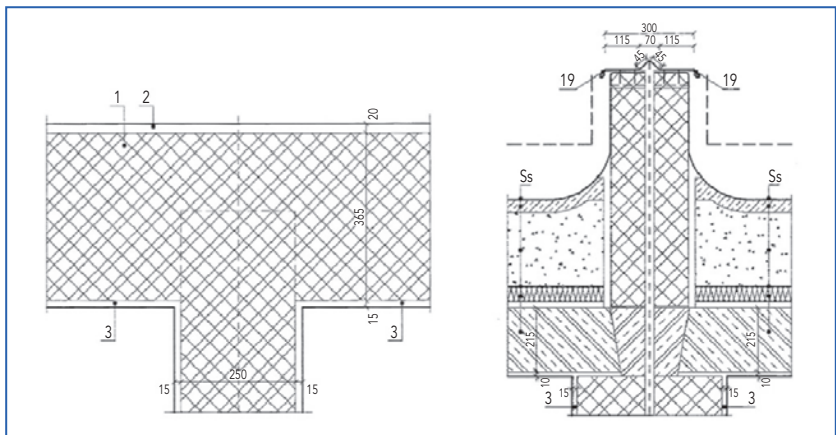


**Figure 23.12.** Multi-family house, row type P1.14  
(concrete+80mm EPS+concrete), [4].



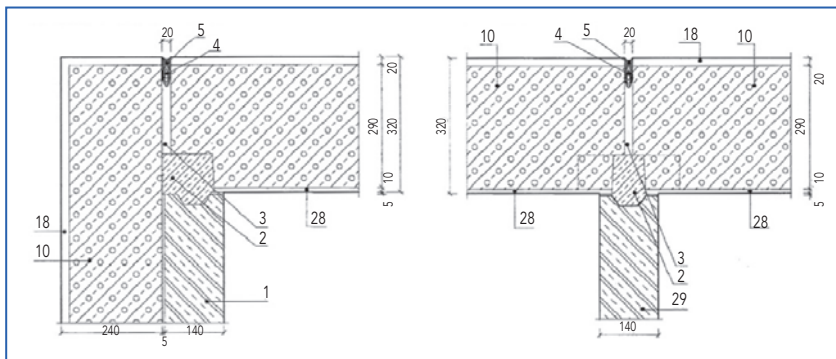
**Figure 23.13.** Typical ground floor detail of detached family house.

The brick was used as basic material for first collective construction of multi-family houses as well. Figure 23.14 shows wall details of system T01B to T03B. The dividing wall between dwellings was made by 250 mm brick wall or double 200 mm thick brick wall with 70 mm gap inter in case of two sections dilatation. All interior walls were fitted of 15 mm lime plaster.



**Figure 23.14.** Wall detail (left – plan view, right – section of dilatation) of multi-family house types T01B to T03B, [9].

The most used system of prefabricated panel technology was T06B with regional variants and various material options. The skeleton was made by reinforced concrete 140 mm thick panels, covered by slag pumiceous ceramsite concrete panels (see Figure 23.15).

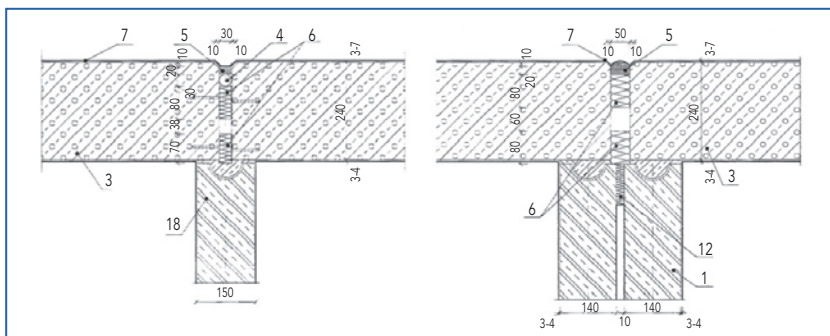


**Figure 23.15.** Plan view of multi-family house wall type T06B-KE (left – corner, right - contact of peripheral panels), [9].

Figure 23.16 shows another version of T06B for region Nitra (NR). The cover walls were made by aerated concrete panels. The sound insulation between two sections with dilatations was above-average compared to single 150 mm thick concrete panel. The airborne sound insulation of

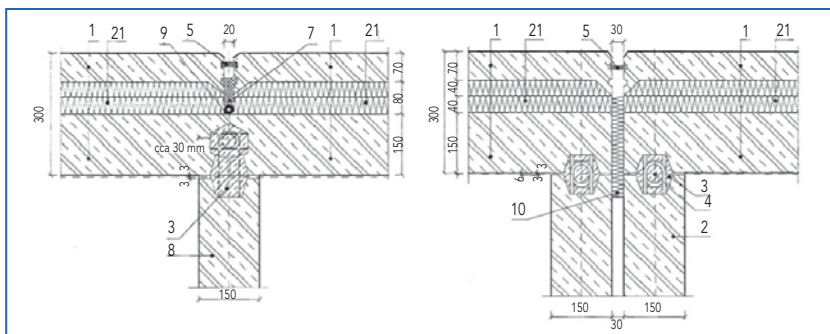


single concrete panel 140 mm thick is about  $R'_w = 48$  dB which is insufficient in term of current normative requirements for dwellings.



**Figure 23.16.** Plan view of multi-family house wall type T06B-NR (left – contact of peripheral panels, right - dilatation of row sections), [9].

Concrete panels as dividing wall between dwellings was used in most of the prefabricated panel technology for multi-family houses until 1989 when collective construction of dwellings ended with the end of communism; from 1992 on no houses were constructed with this system anymore.



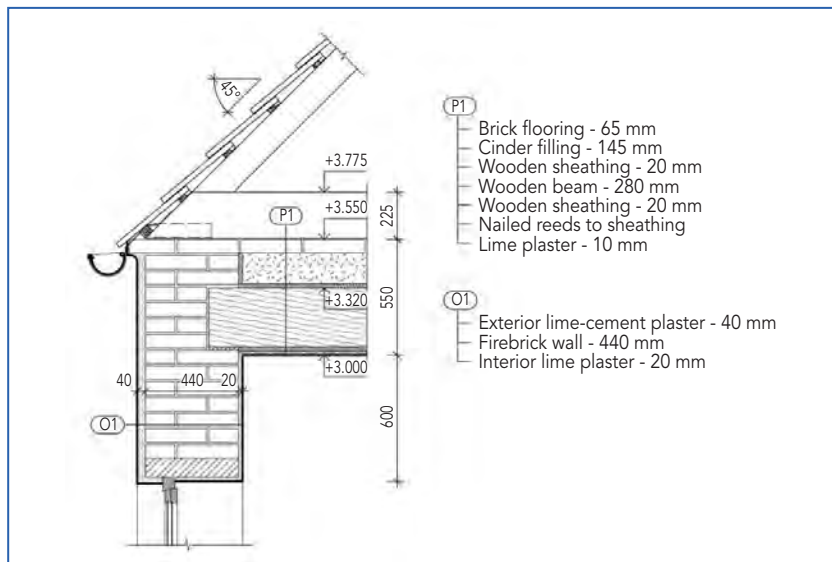
**Figure 23.17.** Plan view of multi-family house wall type P 1.14 (left – contact of peripheral panels, right - dilatation of row sections), [9].

### 23.1.2.4. Floor constructions

The typical most used type of floor supporting structure for family houses before 1965 was massive wooden floor. Figure 23.18 shows floor detail of



detached family house made by massive wooden beam (section 200/280 mm) with wooden sheathing on top and bottom of the beam, approximately 150 mm of cinder filling and floor covering on the top. The thickness of floors like this was around 500 to 600 mm in total. The airborne and impact sound insulation for this structure was quite good in terms of no acoustic regulations in that time. After 1965 new ceramic ceiling systems came into use.



**Figure 23.18.** Typical roof and floor detail of detached family house

In the collective construction of dwellings there in forced concrete slab was the mostly used type of ceiling. Figure 23.19 shows floor details for multi-family house types T01B – T03B. The load-bearing slab was made by reinforced concrete hollow panel, 215 mm thick with a heavy floating panel, 215 mm thick with a heavy floating floor on top. The biggest defect of this system was no insulation between screed and wall to establish a fully floating floor on resilient layer made by glass felt.

In construction system T06B-KE the floor was made up as a heavy floating floor. It consisted from the bottom of 120 mm reinforced concrete panel, 20 mm basalt wool, 40 mm concrete screed and PVC flooring on the top. The screed was correctly separated from the wall around the perimeter (see Figure 23.20).

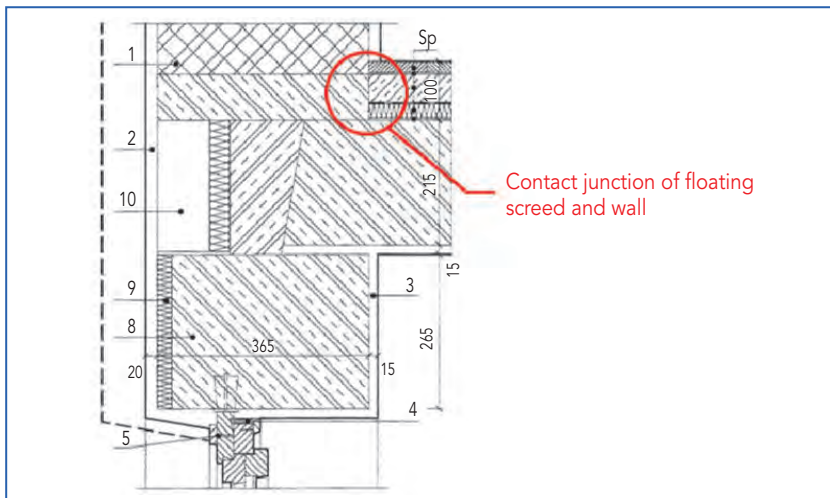


Figure 23.19. Detail of floor junction in T01B to T03B systems, [9].

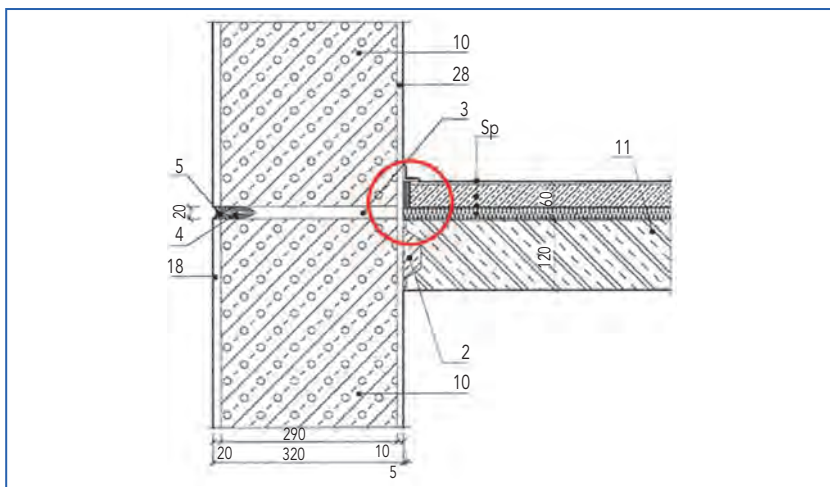
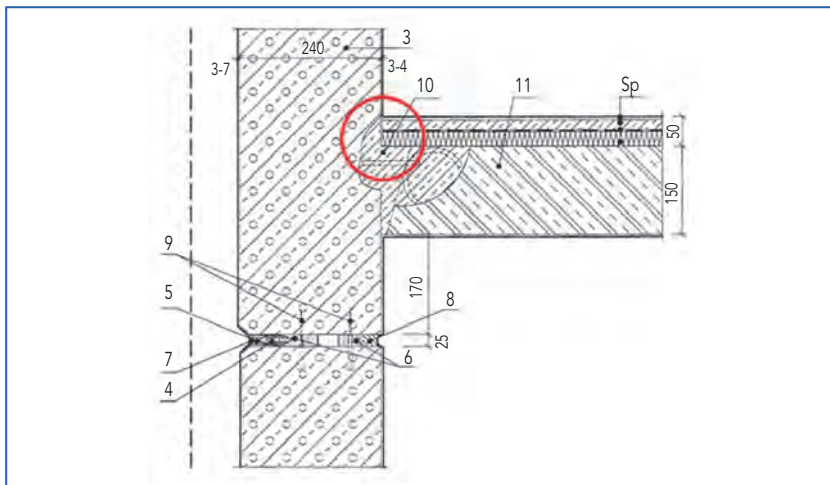


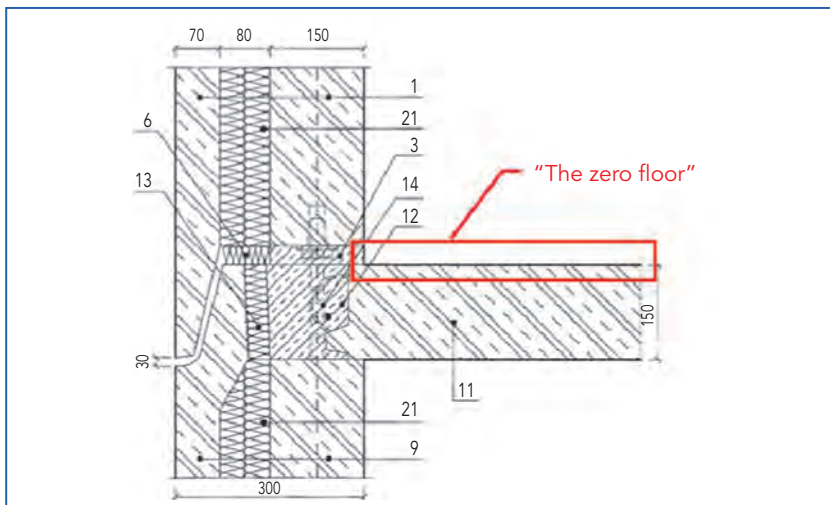
Figure 23.20. Detail of floor junction in T06B-KE system, [9].

In the variant for region Nitra (NR) of T06B the incorrect construction of the floating floor with solid connection of screed with vertical supporting structure is repeated (see Figure 23.21). The floating floor was made of 20 mm concrete screed on 25 mm of polystyrene, which is not a suitable material for an effective floor.



**Figure 23.21.** Detail of floor junction in T06B-NR system, [9].

Another inappropriate solution for a floor was used in system P 1.14 (see Figure 23.22). On top of 150 mm thick reinforced concrete horizontal panel was placed a so-called “Zero floor”. It is just PVC flooring and usually carpet on top. This type of floor has logically bad performance for impact sound insulation.



**Figure 23.22.** Detail of floor junction in system P 1.14, [9].



### 23.1.2.5. Typical causes of acoustic discomfort

Other common bugs besides the ones mentioned in the previous chapter are mainly the following:

- Noise spreading through open vertical installation shaft for pipes and associated building services noise;
- Staircase and elevator located next to quite room and separated by insufficient wall;
- No separation between the staircase construction and the common wall with bedroom or another quite room of flat;
- Other ordinary design or realization mistakes in building acoustic.

## 23.1.3. 3th period 1993 - present

### 23.1.3.1. Buildings characterization

Current structures, materials and technological systems, used for the construction of new apartment houses make a significant contribution to improving the overall quality of housing. They influence architectural and mass-spatial solutions. Nowadays the construction of buildings requires good design, energy saving and fast construction and mounting.



**Figure 23.23.** Examples of current apartment buildings built in Slovakia [11].

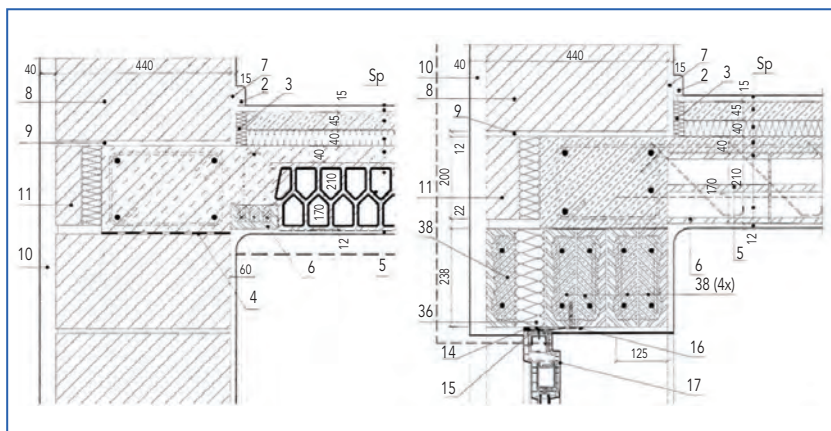


For the construction of the current residential buildings the following construction systems (CS) are used:

- masonry wall CS (bricks, lightweight and aerated concrete, etc.),
- wall CS from cast concrete,
- box CS from cast concrete,
- skeleton CS filled with masonry,
- combined CS (statically, materials) [11].

### 23.1.3.2. Wall constructions

*Ceramic masonry* (on the basis of baked clay) achieves required thermal and acoustical properties by using lightened crap. They are appropriate for building of smaller objects up to a height of 5 floors.

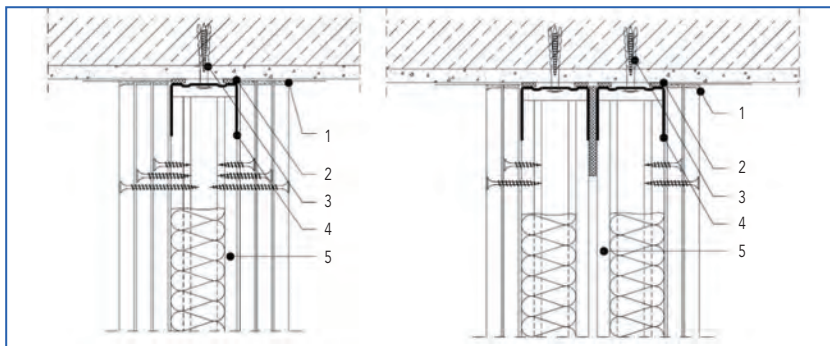


**Figure 23.24.** Details of ceramic brick system Porotherm - floor junction (left), cap (right) [10].

*Masonry on the basis of lightweight and aerated concrete* has good thermal and thermo-accumulating properties as well as low diffusion resistance. It has low basic weight, therefore low  $R_w'$ .

*Masonry on the basis of concrete filled with organic material.* This system consists of bricks from special material - organic material on the basis of wood and cement. To achieve required thermal and acoustical properties, thermal insulation is added into the special bricks. The thermal insulation is situated on the outer part of the brick.

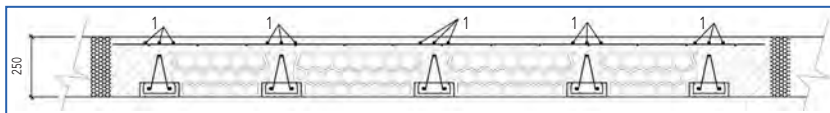




**Figure 23.27.** Details of joint of lightweight wall and floor from reinforced concrete. There is a steel plate inside partition wall (right) [10]

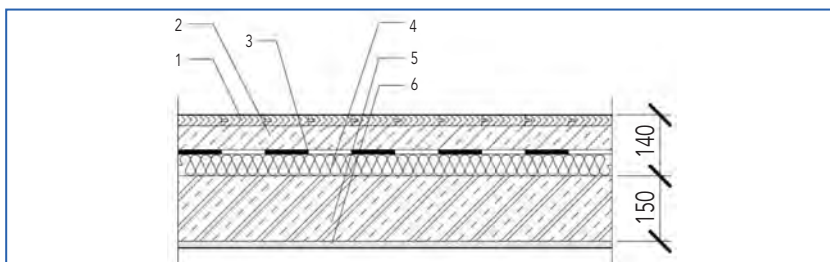
### 23.1.3.3. Floor constructions

Light half-mounted floors are one of the most used floors for dwellings. The advantage of such system is easy, less time consuming building process. It has high fire protection and variability.



**Figure 23.28.** Cross-section of ceramic half-mounted floor [10]

Reinforced concrete floors have the advantage of high basic weight but they always have to be combined with a floating floor. We mainly use heavy floating floor in Slovakia.



**Figure 23.29.** Cross-section of ceiling from reinforced concrete with floating floor on the top of it [10].

Lightweight floors in Slovakia are mainly floors from aerated concrete. This system has good thermal and thermo-accumulating properties as



well as low diffusion resistance. The advantage is a very short building time. It has low basic weight, therefore low  $R_w'$ .

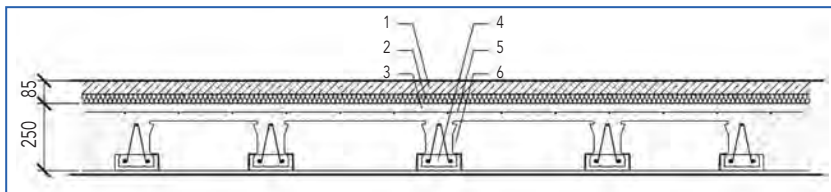


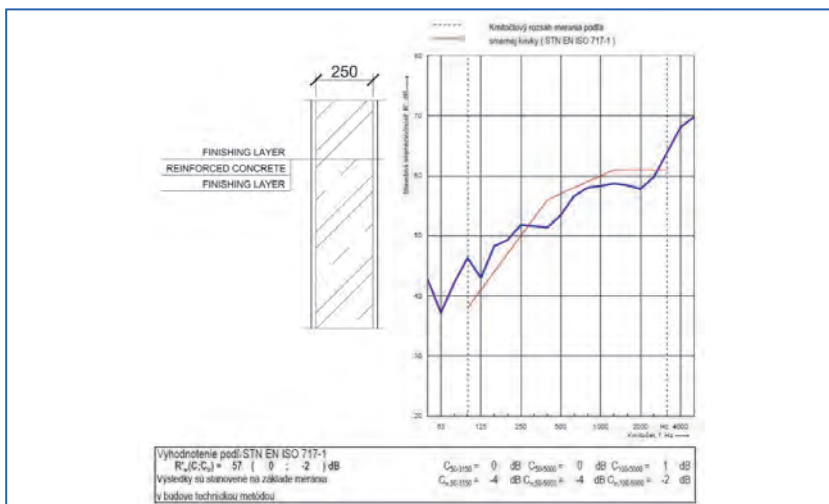
Figure 23.30. Cross-section of ceiling from reinforced concrete with floating floor on the top of it [10].

### 23.1.3.4. Examples of measured constructions

The problem of measurements in Slovakia is that most of them are done on request of current owners or occupiers. Therefore in many cases we are not able to find real composition of measured construction (wall, floor). In the stage of designing apartment houses, designers just theoretically calculate sound insulation of planned constructions. Only in a few cases, are the constructions also consulted with expert in acoustics. It is always hard to retrospectively find details about them since we don't have access to plans of buildings.

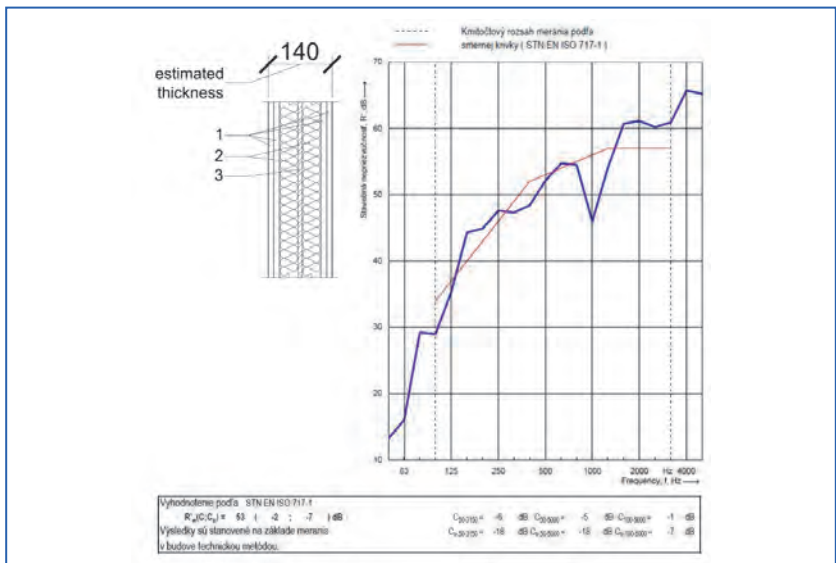
Here are some examples of measured constructions (walls, floors):

- Reinforced concrete wall (250 mm) (Zatko, P.)

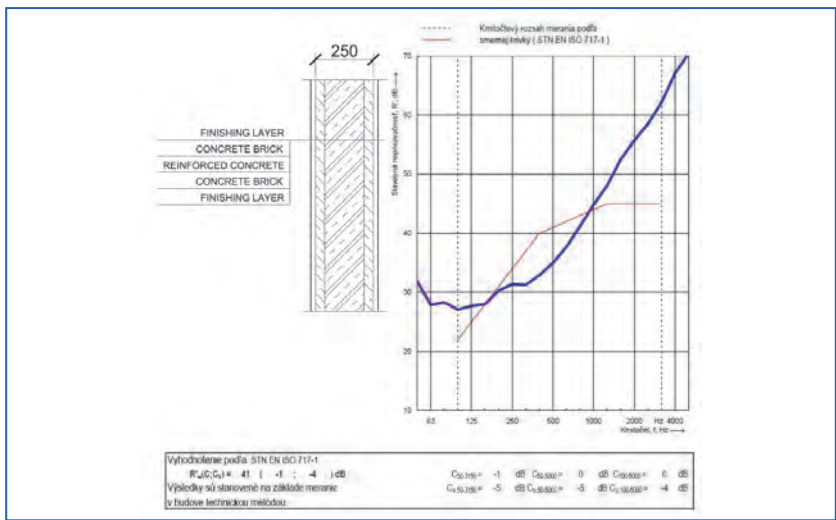




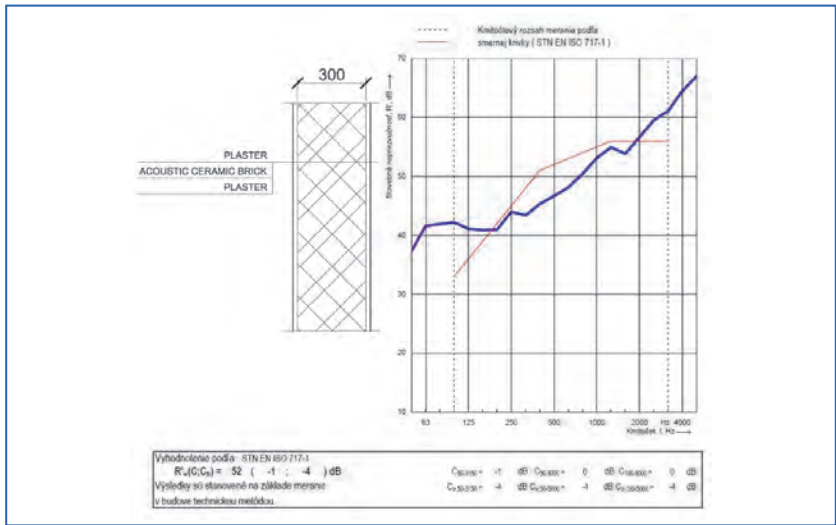
- *Lightweight wall between dwellings - details unknown (thickness, layers)* (Zatko, P.)



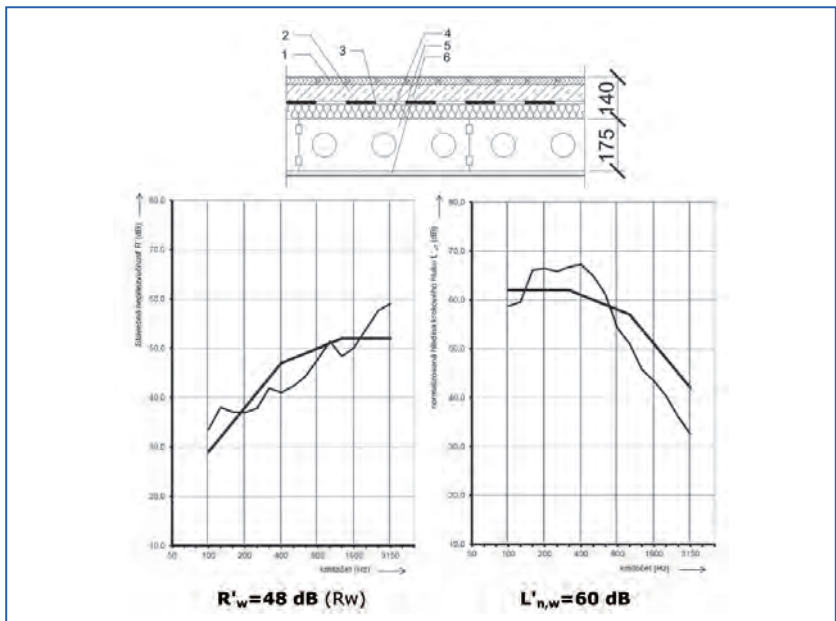
- *Masonry wall from concrete bricks (250 mm) - incorrect built wall, there is light coming through joints of bricks. This could be one of the problems in the construction of dwellings.* (Zatko, P.)



- Masonry walls from special acoustic bricks (Porotherm Akustik 300) (Zatko, P.)

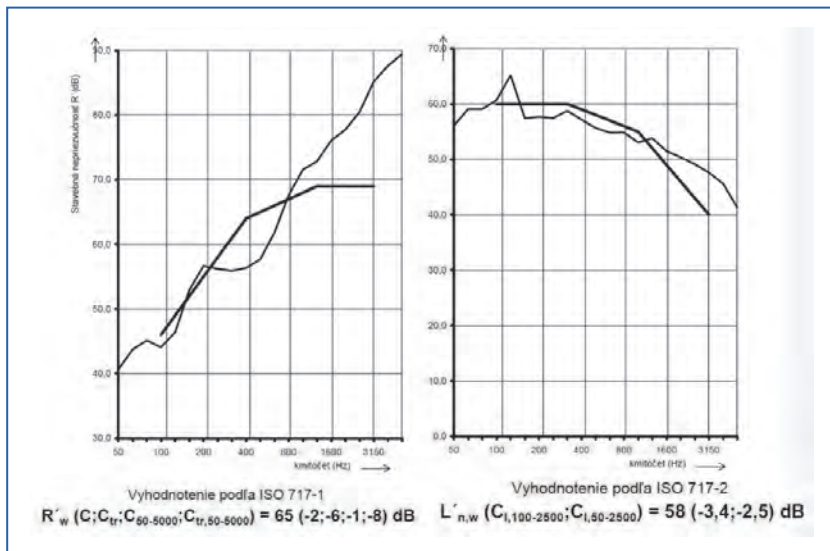


- Ceiling from reinforced concrete panels with heavy floating floor (Dlhy, D.)





- *Unknown floor* - in some cases we can only guess the real description of the floor (Dlhy, D.)



### Requirements in Slovakian standards (based on ISO 717-1,2)

$R'_w = 53 \text{ dB}$  (required)      TZZI I -  $R'_w = 55 \text{ dB}$  (optional)

TZZI II -  $R'_w = 58 \text{ dB}$  (optional)

$L'_{n,w} = 55 \text{ dB}$  (required)      TZZI I -  $L'_{n,w} = 48 \text{ dB}$  (optional)

TZZI II -  $L'_{n,w} = 42 \text{ dB}$  (optional)

## 23.2. Acknowledgement

The measurements were performed by authorized persons Peter Zatko and Dusan Dlhy.

## 23.3. References

- [1] STN 73 0532/2013 *Akustika. Hodnotenie zvukovoizolačných vlastností budov a stavebných konštrukcií. Požiadavky*. Acoustics. Rating of Sound Insulation in Buildings and of Building Elements. Requirements SÚTN SR Bratislava 2013.
- [2] Bureau of Statistics of the Slovak republic. *Population and Housing Census in Slovakia 2011*. April 2013, (online): <http://portal.statistics.sk/showdoc.do?docid=359>

- [3] Ministry of of Transportation, construction and regional development of the Slovak Republic. *Information on housing construction in the Slovak Republic*. 2012, (online): <http://www.telecom.gov.sk/index/index.php?lang=en>
- [4] Ministry of Transportation, construction and regional development of the Slovak Republic. *Intervention into supporting structures of prefabricated housing estates*. 2008, (online): <http://www.telecom.gov.sk/index/index.php?ids=82867>
- [5] Šl'achta, Š., Dorotjaková, I. *Sprievodca po architektúre Bratislavy. Stadtführer durch die Architektur von Bratislava. City Guide to the Architecture of Bratislava*. 1918-1950. Bratislava: Publishing MERITUM, s.r.o., 1996. ISBN 80-88791-16-2
- [6] Kusý, M. *Architektúra na Slovensku 1918-1945. Architecture in Bratislava*. Bratislava: Pallas, Publishing SFVU, 1971. 94-080-70
- [7] Chrobák, V. *Staviteľské konštrukcie I. Building Construction I*. Bratislava: Publishing SVTL, 1964. 63-101-64
- [8] Tomasovic, P., et al. *Akustika budov: stavebná a urbanistická akustika. Acoustics: Building and Urban Acoustics*. Bratislava: Slovak University of Technology in Bratislava. 2009. ISBN 978-80-227-3019-8
- [9] Sternova, Z., et al. *Atlas tepelných mostov. The Atlas of Thermal Bridges*. Bratislava : Publishing Jaga group, s.r.o., 2006. ISBN 80-8076-034-9
- [10] Puskar, A., et al. *Obvodové plášte budov. Building envelope*. Bratislava: JAGA. 2002. ISBN 80-88905-72-9
- [11] Bacova, A., et al. *Bytové domy na Slovensku. Residential Houses in Slovakia*. Eurostav 2007, ISBN 978-80-89228-13-3



# Building acoustics throughout Europe

## Volume 2: Housing and construction types country by country

# 24

## Slovenia

Authors:

**M. Ramšak<sup>1</sup>**  
**M. Čudina<sup>2</sup>**

<sup>1</sup> Slovenian National Building and Civil Engineering Institute, Dimičeva ulica 12,  
1000 Ljubljana, Slovenia  
e-mail: mihael.ramsak@zag.si

<sup>2</sup> University of Ljubljana, Faculty of Mechanical Engineering, Aškerčeva cesta 6,  
1000 Ljubljana, Slovenia  
e-mail: mirko.cudina@fs.uni-lj.si



## CHAPTER

## 24

## Slovenia

## 24.1. Design and acoustic performance

### 24.1.1. Overview of housing stock

Information on the population, building typology and quantity of building stock is presented in this paragraph. Data were taken from Statistical data analysis in the registry of buildings and from the Slovenian report of the TABULA (Typology Approach for Building Stock Energy Assessment) European project.

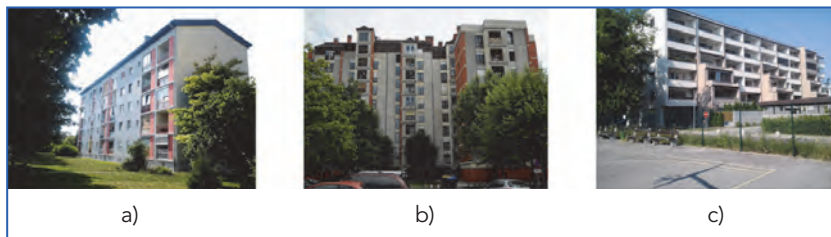
The most common types of residential buildings are: detached houses (single-family and two-family homes – each family in separate floor), attached houses (terraced) and apartment blocks.

#### *The quantities of housing stock and total population*

Slovenia covers approximately 20.000 square kilometres and has a population of approximately 2 million.

The whole residential building stock consists of approximately 524.000 buildings. The total number of dwellings is around 850.000 (based on data for 2008), approximately 383.000 are flats, the rest of them, that means around 467.000, are dwellings in detached and attached (terraced) houses.

Some typical examples of residential buildings from different construction periods are shown in Figures 24.1 and 24.2.



**Figure 24.1.** Apartment blocks: a) 1960-70s; b) 1980-90s; c) after 2000.





**Figure 24.2.** Attached houses: a) 1960-70s; b) 1980-90s; c) after 2000.

### *The most populated cities*

The majority of Slovenian population lives in cities and settlements with less than 100.000 inhabitants. There are two cities with the population over 100.000, namely Ljubljana with around 275.000 and Maribor with around 115.000 inhabitants.

### *Proportion of apartments, terraced (row) and detached houses*

The available data from the overview of typical statistics for new building housing in Slovenia show that around 2.550 residential houses with more than one apartment were built in the period between 2001 and 2010, that means around 255 per year. The number includes apartment blocks and terraced houses. During the same period of time around 26.600 houses with one apartment (detached houses) were built, that means around 2.660 per year.

Increase of building stock for different construction periods is shown in Figure 24.3 were the proportion of buildings with one apartment and with more than one apartment can be seen as well.

#### **24.1.2. New build housing constructions**

##### *The legislation in force in the field of building acoustics*

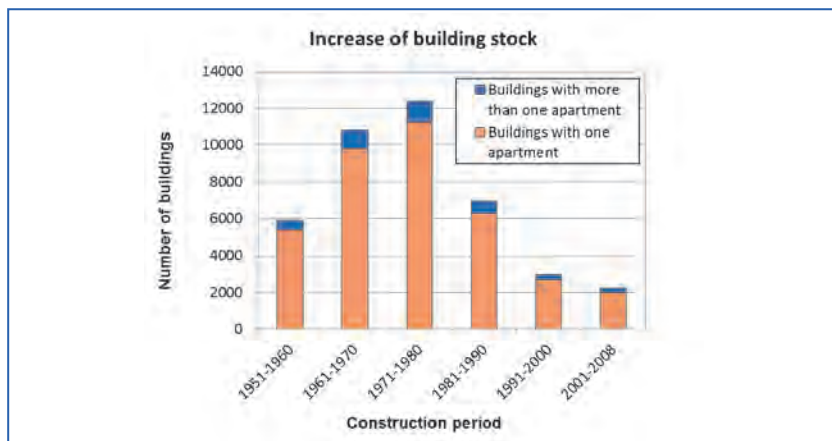
The minimum requirements for protection against noise in buildings are prescribed in 'Regulations on protection against noise in buildings', in conjunction with the technical guidance document 'Protection against noise in buildings' from 2012.

The defined requirements relate to the intended use of the rooms in the building. The minimum requirements for dwellings are listed below:

- required sound insulation performance of the façade depends on the outside noise level and on the inside noise level limit (for dwellings  $L_{Aeq}$ )



- $\leq 35$  dB(A) in the day time period,  $L_{Aeq} \leq 33$ dB(A) in the evening time period and  $L_{Aeq} \leq 30$  dB(A) in the night time period);
- airborne sound reduction index between dwellings:  
 $R'_w \geq 52$  dB in apartment blocks  
 $R'_w \geq 55$  dB in terraced houses (for separating walls);
- impact sound insulation between dwellings:  $L'_{n,w} \leq 55$  dB;
- maximum sound pressure level from service equipment:  
in dwellings  $L_{A,F,max} \leq 30$  dB(A).



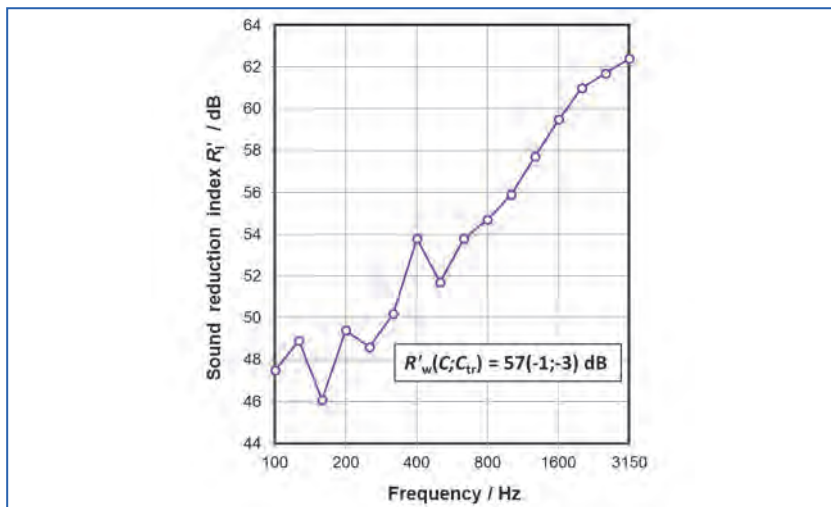
**Figure 24.3.** Average increase of building stock in different construction periods.

### Typical heavyweight constructions

One of the most typical constructions used as a separating wall in new apartment blocks consists of 20 cm thick reinforced concrete with added 5 cm thick layer of aerated autoclaved concrete. The aerated autoclaved concrete is glued to the reinforced concrete. The visible side of the aerated autoclaved concrete is plastered, thickness of the plaster is normally around 1 cm.

Typical sound insulation performance of such a construction with massive flanking elements is presented in Figure 24.4.

The layer of aerated autoclaved concrete is sometimes replaced by a lining made of gypsum board on parallel resilient channels. The depth of the cavity between the gypsum board and the wall is usually between 4 cm and 6 cm, the cavity is filled with the mineral wool.



**Figure 24.4.** Case study: an example of sound insulation performance of typical massive wall between adjoining dwellings in the new build apartment block.

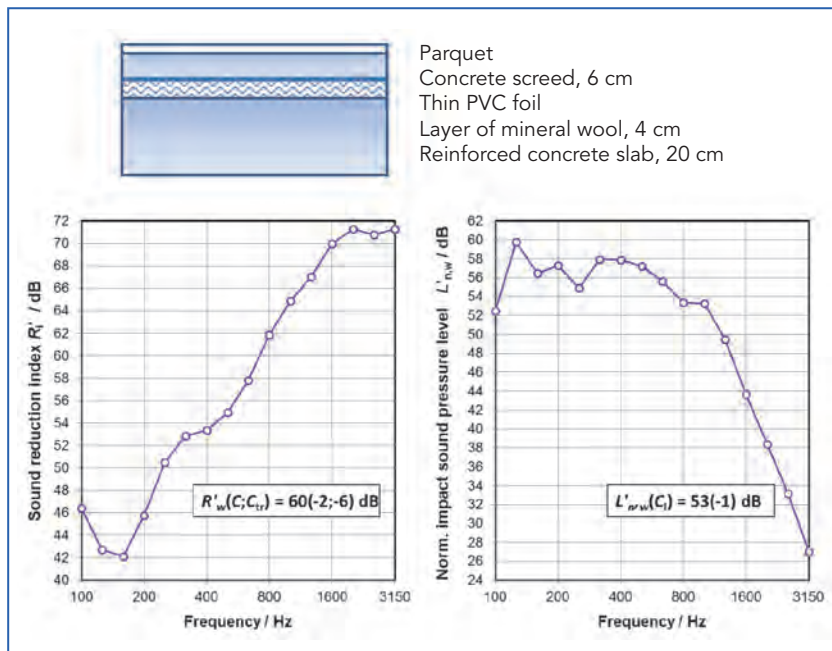
A typical floor construction between apartments in new build apartment blocks consists of parquet on a floating floor, made of concrete screed 6 cm on 4 cm thick layer of mineral wool. The floating floor is laid on a 20 cm thick reinforced concrete slab.

Typical sound insulation performance of such a construction with massive flanking elements is shown in Figure 24.5.

### Lightweight constructions

Lightweight walls have not been often used as separating walls between adjoining dwellings, however, recently they become more and more popular. Typical lightweight wall construction between apartments consists of two separated metal frames with two layers of gypsum board on each side of the wall. Cavity is filled with the sound absorptive material.

The wall is normally placed directly on the bearing reinforced concrete plate in order to substantially reduce the flanking transmission via the floating floor. Typical sound insulation performance  $R'_w$  of such a construction which is built in a massive construction set normally exceed the minimum value of 52 dB, as is prescribed for the partition wall between adjoining dwellings.



**Figure 24.5.** Case study: an example of airborne and impact sound insulation performance of typical massive floor construction between adjoining dwellings in the newbuild apartment block.

Concerning the lightweight floors they have not been typically used between flats in multi-storied buildings until recently, so there is only small amount of data about airborne and impact sound insulation performance available and it is not possible to draw any significant conclusion.

### Typical errors in design and workmanship

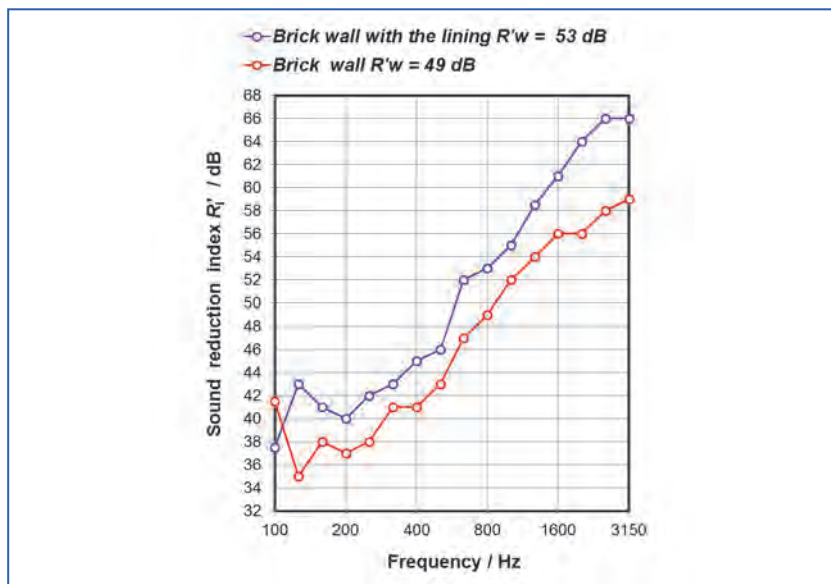
#### Design errors

Problem of inadequate sound insulation performance typically arise when the neighbouring apartments are separated by the common massive wall construction with too low mass per unit area. The hollow brick wall, plastered on both sides, with the total mass of around 300 kg/m<sup>2</sup> is typically used. In terms of sound insulation, designing of such a construction still represents a typical design error.



As a measure to improve the sound insulation, an additional lining is usually used, made of gypsum board on parallel resilient channels. The depth of the cavity between the gypsum board and the wall is usually between 4 cm and 6 cm, the cavity is filled with the mineral wool.

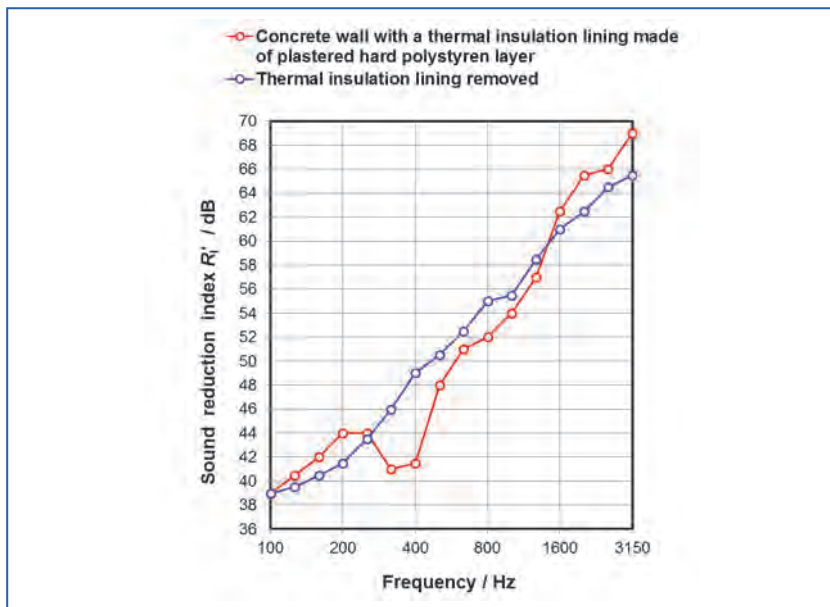
Typical sound insulation performance of the separating construction of this kind is presented in Figure 24.6. It represents the performance before and after the implementation of sound insulation improvement measure.



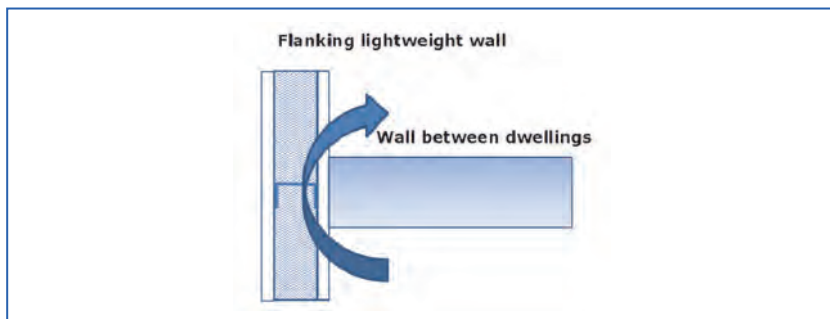
**Figure 24.6.** Case study: an example of sound insulation performance of the brick wall before and after the sound insulation improvement.

Frequently the opposite problem arises when the sound insulation performance decreases because of the resonance caused by adding a lining to the basic construction with a too stiff interlayer. The effect of such a lining on the sound insulation performance is illustrated by the example, presented in Figure 24.7.

Another typical design error relates to the inadequate solution concerning the flanking transmission. In many cases significant reduction of the apparent sound reduction index is the consequence of the inadequate realisation of the junction between the partition and the lightweight flanking element (Figure 24.8).



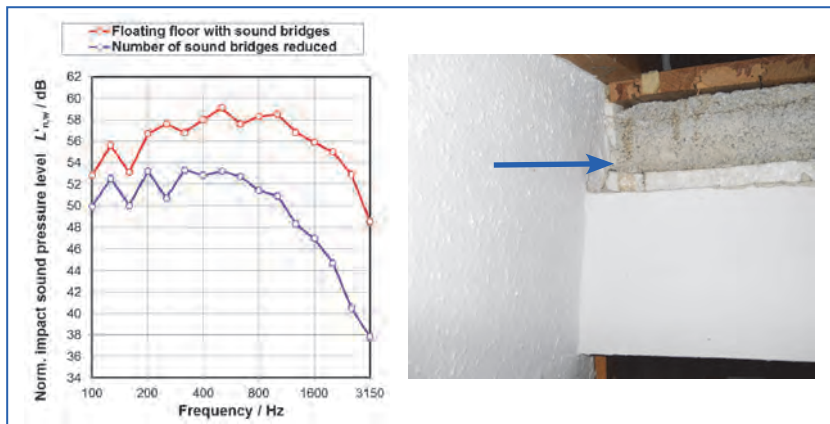
**Figure 24.7.** Case study: an example of sound insulation performance of concrete wall before and after the removal of the inadequate wall lining.



**Figure 24.8.** An example of inadequate realisation of the junction between the separating element and the lightweight flanking element.

### Workmanship errors

A typical error in workmanship of the floor construction relates to rigid junction of concrete screed and wall and leads to reduction in impact and airborne sound insulation performance (Figure 24.9).



**Figure 24.9.** Case study: an example of a rigid contact of wall and screed – acoustic bridge.

In many cases there are no rigid contacts between concrete screed and wall, but rigid contact exist via floor ceramics (Figure 24.10).



**Figure 24.10.** An example of a rigid contact of wall and screed via floor ceramics.

### 24.1.3 - Existing housing

*Typical constructions found in existing stock and their sound insulation performance*

Most data about airborne and impact sound insulation performance is available only for the buildings from the period between 1980 and 2000.

Two predominating types of massive walls between adjoining dwellings were realized in the buildings from that period. The first typical example of wall between adjoining dwellings was made of reinforced concrete 15 cm, plastered on both sides with the layer of plaster  $\sim 1,5$  cm, a surface mass of the wall was about  $390 \text{ kg/m}^2$ . The second typical example of wall was made of 29 cm thick hollow bricks, plastered on both sides with the layer of plaster  $\sim 1,5$  cm. Mass per unit area of the wall was approximately  $410 \text{ kg/m}^2$ .

The typical sound insulation performance  $R'_w$  of the both types of walls was found to be between 52 dB and 55 dB, based on measured data.

Typical facades of buildings were made of 29 cm thick hollow bricks, plastered on the inner side and with the 5 cm thermal insulation layer on the outer side. Estimated typical sound insulation value  $R'_w$  of such a façade was around 52 dB. Typical sound insulation performance of windows  $R'_w$  was about 26 dB (average value based on measured data). It was found out that the main reason for such a bad sound insulation performance was not a bad glazing composition. It was mainly a consequence of the bad sealing, deterioration of a window sash and frame and of the bad sound insulation performance of a shutter box.

The characteristic types of massive floors in buildings from that period and their sound insulation performances are presented in Figure 24.11 and Figure 24.12.

### *Methods for improving sound insulation*

In order to improve the acoustic performance of existing buildings the measures listed below are taken.

To improve sound insulation of facades the replacement of existing windows and shutter boxes is realized in most cases.

To improve airborne sound insulation normally wall linings are used, made of plasterboard on resilient channels and with mineral wool in the cavity.

Floating floors are used to improve the impact sound insulation of floors. In case it is not feasible to realize the floating floor (for example the residents do not allow doing it in their apartment), the floor and wall linings are used in the receiving room, made of plasterboard on resilient channels and with mineral wool in the cavity. In case of acoustic leaks, for example through the ventilation pipes, silencers are used.



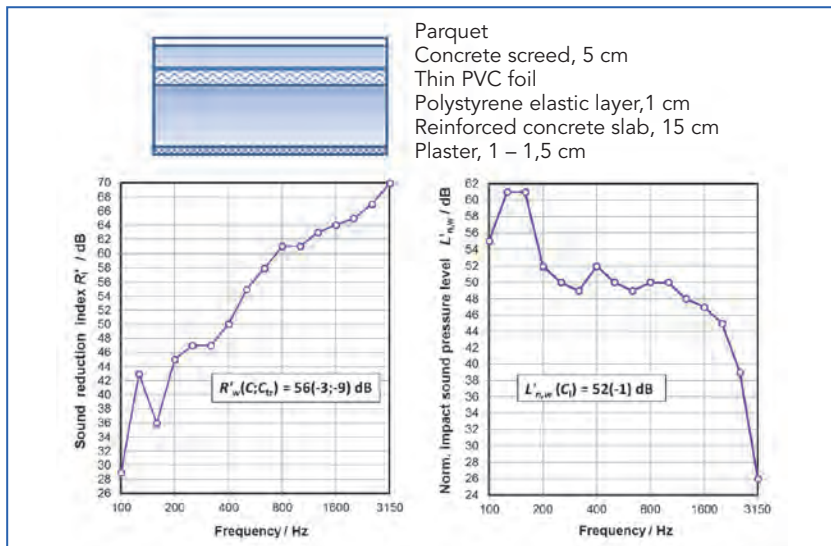


Figure 24.11. Case study: sound insulation performance of typical floor construction with reinforced concrete slab.

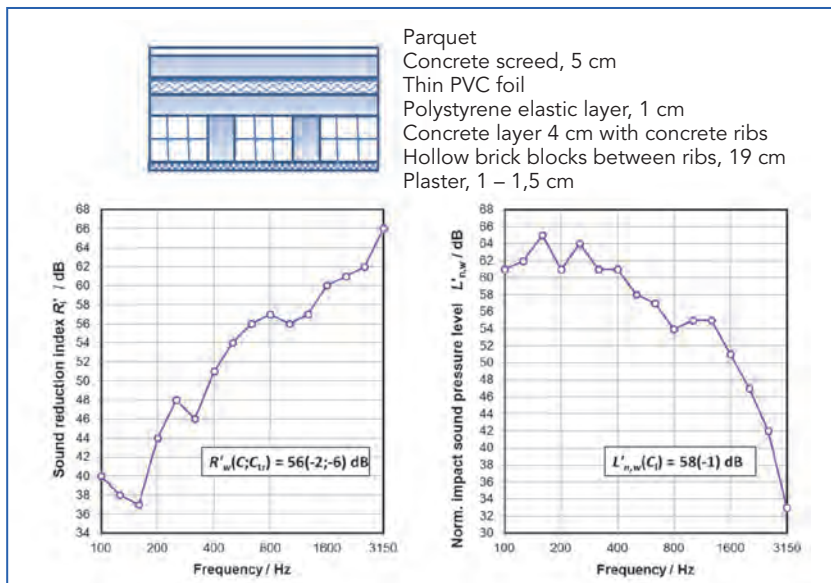


Figure 24.12. Case study: sound insulation performance of typical floor construction with hollow bricks.

## 24.2. References

- [1] <http://extranet.cstb.fr/sites/cost/ebook/Forms/AllItems.aspx>.
- [2] [http://w3.cost.esf.org/index.php?id=240&action\\_number=TU0901](http://w3.cost.esf.org/index.php?id=240&action_number=TU0901).
- [3] [http://w3.cost.esf.org/index.php?id=240&action\\_number=TU0901](http://w3.cost.esf.org/index.php?id=240&action_number=TU0901).
- [4] <http://www.costtu0901.eu/>.
- [5] <https://en.wikipedia.org/wiki/Slovenia>.
- [6] Rakušček A., Šijanec Zavrl M., Stegnar G., Typology Approach for Building Stock Energy Assessment - National scientific report on the TABULA activities in Slovenia, Gradbeni inštitut ZRMK, d.o.o., Ljubljana, ISBN 978-961-6712-03-9, May 2012, <http://www.building-typology.eu/>.
- [7] Statistics on data from Registry of buildings (REN), prepared by Geodetic Institute of Slovenia, 2008.
- [8] Unpublished results of impact and airborne sound insulation measurements, Archive ZAG Slovenian National Building and Civil Engineering Institute, Ljubljana.



# Building acoustics throughout Europe

## Volume 2: Housing and construction types country by country

# 25

## Spain

Authors:

**T. Carrascal García<sup>1</sup>**  
**M. Machimbarrena<sup>2</sup>**  
**C. Monteiro<sup>2</sup>**

<sup>1</sup> Instituto de Ciencias de la Construcción Eduardo Torroja, Madrid, Spain

<sup>2</sup> Departamento de Física Aplicada, ETS Arquitectura, Universidad de Valladolid, Valladolid, Spain



## CHAPTER

## 25

## Spain

## 25.1. Overview and Housing Stock

## 25.1.1. Overview of housing stock

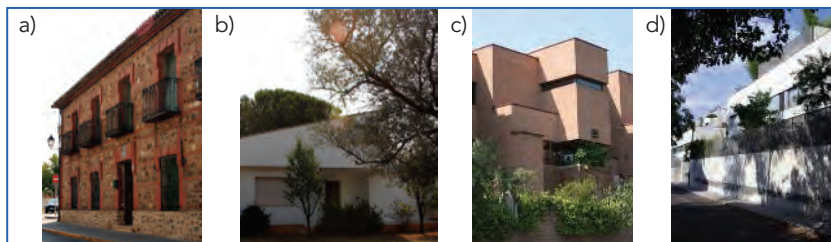
Spain has a population of 46 million inhabitants and the most populated cities are Madrid, Barcelona, Valencia and Sevilla. There are 25,2 [1] million dwellings. Approximately 25% of new built houses are single family houses (terraced, semi-detached and detached houses) and the rest, 75% of the total housing stock, are apartments. Figures 25.1 and 25.2 show examples of dwellings found across Spain.

Economic growth from 1998 to 2008 and the property bubble fuelled the construction of more than 5 million dwellings at its highest rate in the year



**Figure 25.1.** Examples of attached houses found across Spain.

a) before 1900's; b) 1930-40; c) 1980's; d) 2007.



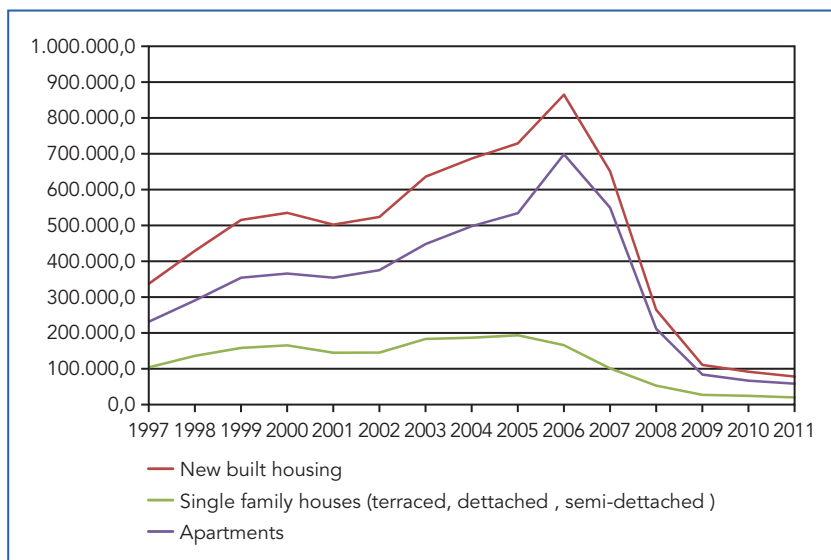
**Figure 25.2.** Examples of single family houses (terraced, semidetached and detached houses) found in Spain. a) before 1900's; b) 1960-70; c) 1980's; d) 2000.



2006: 0,920 million new houses. Subsequently, construction rates plunged by more than 50% each year. In 2011 the total number of new homes was 69.746 [2] and the prospects for the next years<sup>1</sup> are no better. According to the CSCAE, National Association of Architects in Spain, the number of new homes built in the first half of 2012 was 4.120. (See figure 24.3).

Regarding sound insulation and regulations, it was in 2009 when the document *DB HR Protection against noise* was approved. This document established new sound insulation requirements for new housing and it has been a big step towards increasing the acoustic insulation of dwellings, as it upgraded sound insulation requirements and brought them closer to those existing in the most demanding European countries.

Unfortunately this regulation was approved in the first years of the construction sector crisis and very few new buildings have been built, which, in terms of sound insulation, means that approximately 200.000 dwellings out of a total of 25M (0,83%) meet the actual standards. Most of the population in Spain in 2013 is living in homes with an estimated sound insulation of  $D_{nT,A} \leq 40$  dB on average.



**Figure 25.3.** New built houses per year.

<sup>1</sup> 2012 data are still not ready. The only available data belongs to the first term of 2012.

## 25.2. Requirements

The first regulation on sound protection NBE CA-81[3] came into force in 1981 and was later modified in 1988. It included requirements for vertical, horizontal and façade building elements used between dwellings. The minimum sound reduction index was set to be  $R_A \geq 45$  dB and the maximum normalized impact sound pressure level was  $L_{n,A} \leq 80$  dB (laboratory test requirements).

It was not until 2009 that the acoustic requirements in dwellings were updated and the Document *DB HR Protection against noise* [4] came into force. This document is just one of the many documents included in the Spanish Building Code (CTE). In particular, DB HR sets the noise insulation requirements, which are summarized in the tables 25.1, 25.2 and 25.3. [5].

The *DB HR* applies to new buildings, but also to major alterations, restorations, conversions and extensions undertaken in existing buildings. Nevertheless, there are some exceptions to the application of the requirements: when the building is protected because of its historical or architectural interest, or when the works to upgrade sound insulation values to the current requirements are not technically feasible. In these cases, the “flexibility clause” may apply, that is to say, builders must enhance the existing sound insulation even when the requirements cannot be reached.

In the case of the retrofitting of an area within a building, such as a floor or a dwelling, requirements should be reached, but it is also possible to apply the “flexibility clause”.

Table 25.4 contains indoor quality objectives set by Spanish Noise Law [6], which is the transposition of the Environmental Noise Directive (2002/49/EC).

In situ tests are optional, only in some regions like Castilla y León, Andalucía and the city of Valencia, local administrations require them before the Practical Completion Certificate.

The Spanish Building Code allows a deviation of  $\pm 3$  dB between the requirements and the in situ test results for airborne, impact and façade sound insulation, due to measurement uncertainties. This tolerance is nowadays used in case of court conflict. Nevertheless all Spanish accredited laboratories and consultants must have developed an uncertainty calculation procedure duly approved by the Spanish Accreditation board and this could also be used in case of confronting a court situation.

**Table 25.1.** Airborne sound insulation requirements

Type of space	Requirement $D_{nT,A}$ (dB)	Frequency range (Hz)
Between protected spaces, such as bedrooms, living rooms, classrooms...etc. and other premises outside the living unit(*) (dwelling)	$\geq 50$ dB	100-5000
Between habitable spaces, such as kitchens, bathrooms, halls, corridors, etc. and other premises outside the living unit (dwelling)	$\geq 45$ dB	100-5000
Between noisy areas such as equipment rooms or activity (+) rooms and protected spaces.	$\geq 55$ dB	100-5000

(\*) Noise insulation requirements in Spain also apply to hotels, student halls, schools, and hospitals. A living unit is a part of a building used for a specific purpose, whose occupants are linked like a family, a corporation or any organization. The DB HR mentions various examples of living units such as dwellings, hospital rooms, hotel rooms, classrooms, etc. In this case, a living unit is a dwelling.

(+) Activity rooms are premises with an A-weighted sound pressure level up to a 70dBA. Leisure activity premises such bars, pubs, discos, workshops, etc. where the sound pressure level usually exceeds 70 dBA are considered "noisy premises", and the DB HR does not apply to them. In that case, it is the local authority that sets the noise insulation requirements and this is related to the type of activity license.

**Table 25.2.** Impact sound insulation requirements.

Type of space	Requirement $L'_{nT,w}$ (dB)	Frequency range (Hz)
Between protected spaces and other premises outside the living unit (dwelling)	$\leq 65$ dB	100-5000
Between noisy areas such as equipment rooms or activity rooms and protected spaces.	$\geq 60$ dB	100-5000

**Table 25.3.** Sound insulation of the envelope.  $D_{2m,nT,Attr}$  (dBA), between protected rooms and external noise sources (function of day  $L_{eq}$ ).

$L_d$ dBA	Type of building			
	Dwellings and hospitals		Cultural, medical, educational centres and office buildings	
	Sleeping rooms	Living areas	Living areas	Classrooms
$L_d \leq 60$	30	30	30	30
$60 < L_d \leq 65$	32	30	32	30
$65 < L_d \leq 70$	37	32	37	32
$70 < L_d \leq 75$	42	37	42	37
$L_d > 75$	47	42	47	42

**Table 25.4.** Indoor quality objectives set by Spanish Noise Law.

Type of building	Type of room	Equivalent continuous A-weighted sound pressure level		
		$L_d$	$L_e$	$L_n$
Dwellings	Living areas	45	45	35
	Sleeping rooms	40	40	30
Hospitals	Living areas	45	45	35
	Sleeping rooms	40	40	30
Educational and cultural centres	Classrooms	40	40	40
	Libraries	35	35	35

There is no deviation allowed between the project value and the requirements, as constructions should be designed to meet at least the requirements. There is not a classification scheme, so the requirements are the project values.

### 25.3. New build housing constructions

In the last three years 74% of Spanish new build homes were apartments. Typically new apartment blocks have a supporting structure consisting of a series of reinforced concrete pillars and slabs, where walls often infill the gaps left by this framework. Therefore separating walls are not supporting walls and they usually rest on a continuous concrete slab that connects different apartments.

Regarding house separating floors, beam and block floors and grid floors are the most usual, with an average surface mass of 350 kg/m<sup>2</sup>. Enough impact insulation can be achieved by installing floating floors, consisting of an impact insulation layer and a concrete screed, at least 50 mm thick.

Terraced and semidetached houses are similar to flats. Their supporting structure is typically formed by a series of pillars or walls and continuous slabs which run along the different houses. Dwellings usually share the same party wall and there is not a void or expansion joint between the houses. So, it is necessary to provide enough horizontal impact insulation between terraced or semi-detached houses to prevent structureborne noise from attached houses.

Light frame construction is not common in apartments and it is seldom used in country single family detached houses, where there are neither airborne, nor impact insulation requirements.





Because of this, the following sections of this chapter will focus on constructions in apartments, bearing in mind that most of the examples given can be found in both: apartments and single family attached houses.

First some examples of walls will be presented, then examples of floors. Each section will contain the description of each wall or floor, important joints and key features in workmanship. Finally, the installation of bathrooms will be presented as a special feature.

### 25.3.1. Separating Walls

There are typically 3 types of separating walls, which correspond to the ones proposed in the Basic Document DB HR Protection against noise.

#### Type 1. Masonry between independent linings

This type of walls consists of a single leaf masonry wall with one or two layers of gypsum boards fixed to independent steel frames.

The masonry core is usually either a 120 mm solid brick wall ( $160 \text{ kg/m}^2$ ) or a 70 mm hollow brick wall ( $70 \text{ kg/m}^2$ ), but any other masonry materials such as light concrete blocks ( $1200 \text{ kg/m}^3$ ) or cast concrete walls can be used.

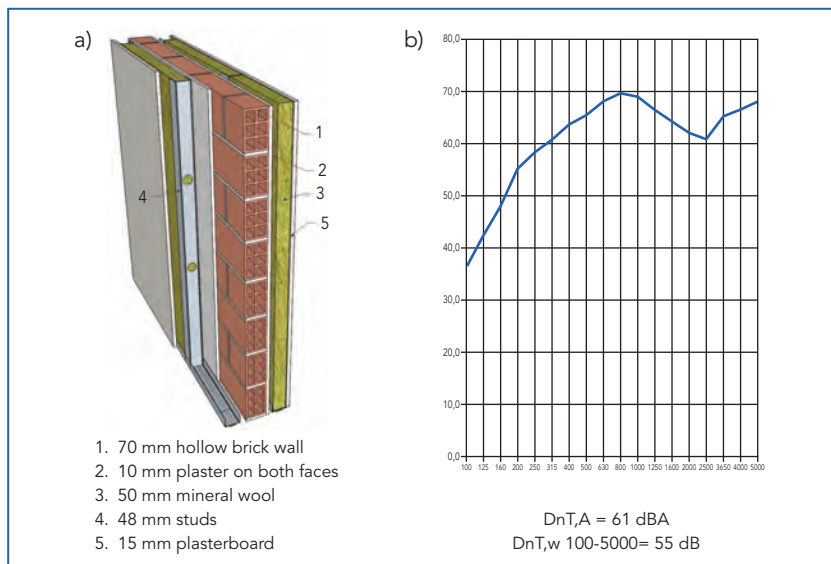
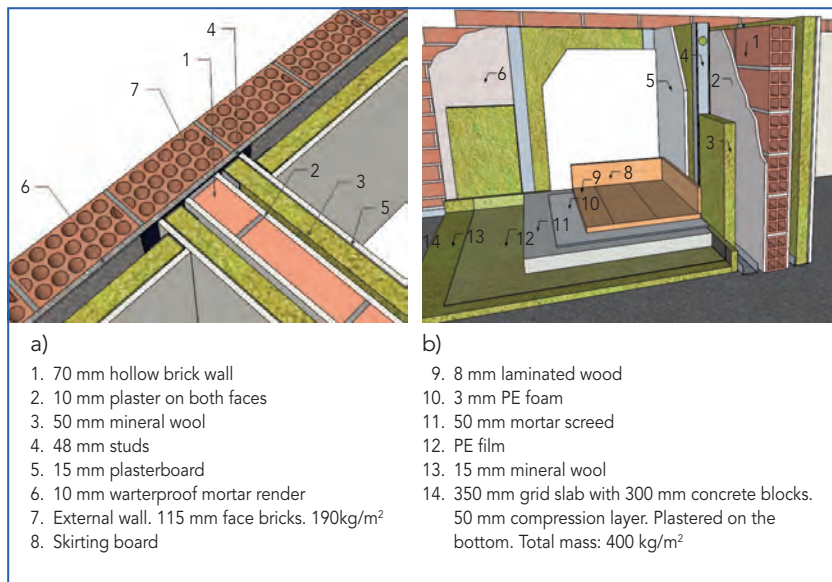


Figure 25.4. a) Example of Type 1 separating wall. Masonry between independent panels. b) Typical airborne sound insulation.



**Figure 25.5.** Example of Example of Type 1 separating wall. Masonry between independent panels. a) Façade junction. b) Floor junction.

Each independent lining in most cases, increases the insulation of the masonry wall around 10 dB or even more. A typical steel frame is composed of 48 mm C studs, screwed to the floors. The independent linings must never make contact with the masonry wall, so the frame must be selected depending on the height of the room to ensure structural stability. If any of the vertical studs are tied to the masonry wall, there will be a reduction in sound insulation. It is important that each cavity on each side is filled with absorbent material, generally 50 mm mineral wool.

Figure 25.4 shows typical performance of a type 1 wall. In the case of the figure, the masonry wall is rigidly connected to the floor and to the external wall. Figure 25.5 shows junctions details.

## Type 2. Heavy cavity walls

Type 2 walls consist of two leaf masonry walls separated at least 40 mm, with a mineral wool quilt (figure 25.6). Typical walls are as follow:

- **Type 2.1:** Two 70 mm hollow ceramic walls, 70 kg/m<sup>2</sup> each, rendered on both faces, thus resulting in a cavity wall 210 mm wide. See figure 25.6.

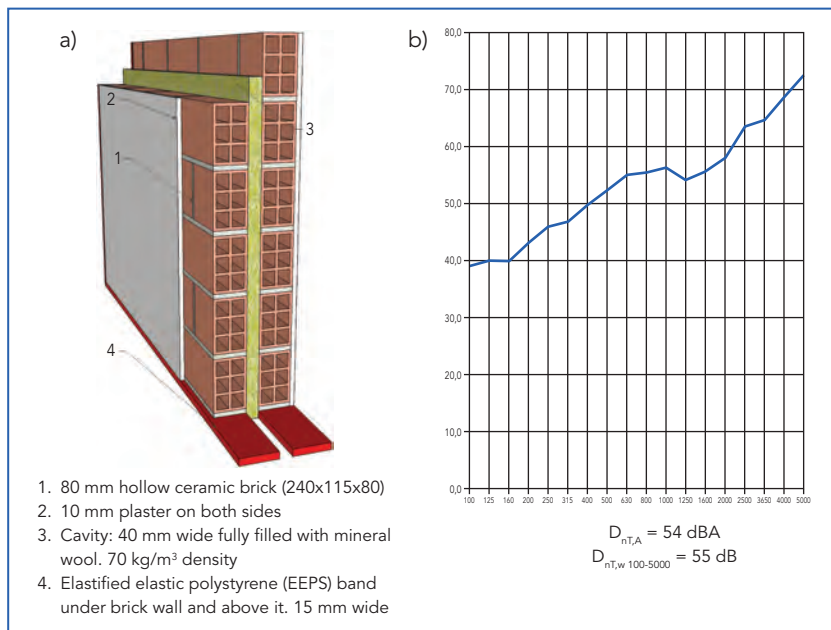


- **Type 2.2:** 50 or 70 mm hollow light ceramic wall ( $70\text{kg/m}^2$ ), rendered (10 mm) and a 115 mm solid ceramic wall rendered ( $160\text{ kg/m}^2$ ); total width is 235-255 mm.

The performance of cavity walls is limited by the transmission along the floor and ceiling as well as by the transmission of any type of tie that bridges both leaves. To meet the requirements, elastic layers must be placed at top and bottom of each hollow light ceramic wall, as well as in the corresponding junctions with the façade and other inner walls. The most common material used is EEPS (elastified expanded polystyrene) 10 mm wide. EEPS dynamic stiffness value varies from 15 to  $10\text{ MN/m}^3$  or even less. The Spanish DB HR requires to use elastic interlayers with dynamic stiffness  $< 100\text{ MN/m}^3$ .

In the second type of wall, type 2.2, the solid ceramic wall weighting more than  $160\text{ kg/m}^2$  is rigidly attached to the floor and the hollow light ceramic wall needs to have acoustic elastic layers in its perimeter.

As for the junctions with the external walls, it is crucial for the inner leaf of the façade not to bridge both leaves of the separating wall as shown in



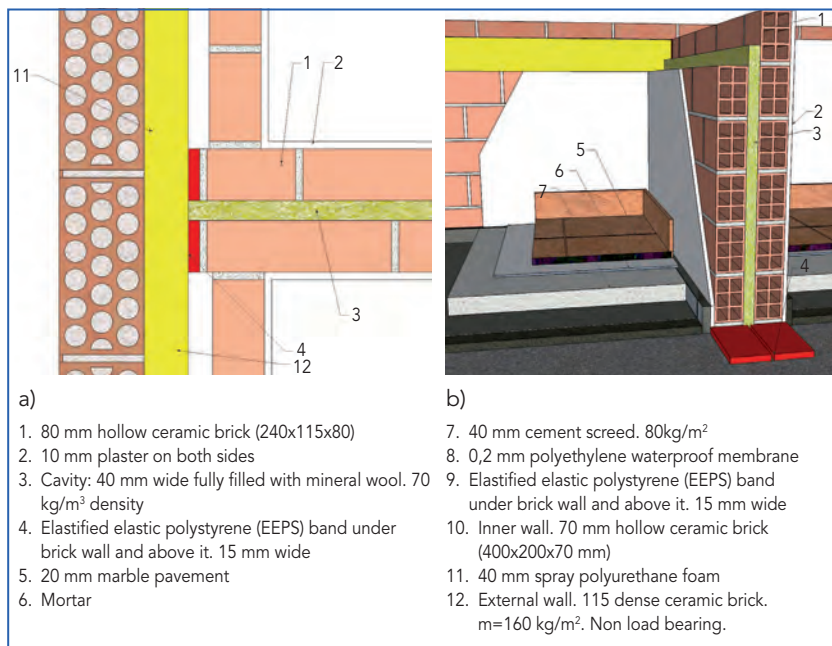
**Figure 25.6.** a) Example of Type 2 separating wall. Cavity wall.  
b) Typical airborne sound insulation.



figure 25.7 where the inner wall is interrupted by the separating wall. A break in the construction prevents flanking transmission that otherwise would reduce the performance of the wall by 8 dB. The façade cavity should be interrupted in the junction with the separating wall. In this example, the separating wall abuts the rigid insulation and some elastic bands are placed in it.

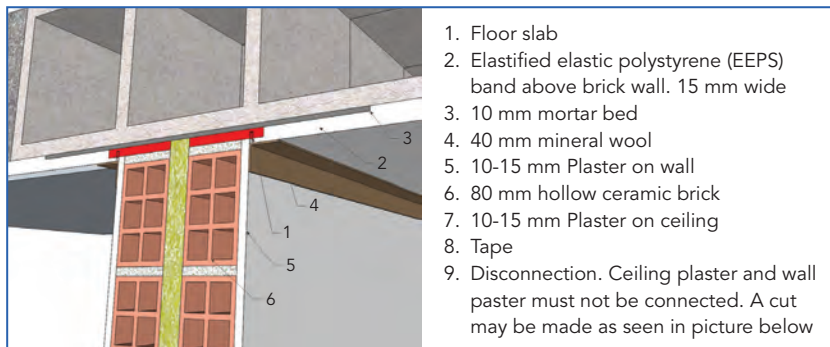
To reach the required performance level, it is crucial to avoid bridges between the walls and the surrounding floors, walls, etc., this includes avoiding connections between the plaster finishes of the walls and the ceiling above. As shown in figures 25.8 and 25.9, it is common practice to perform a cut with a finishing trowel or a similar tool to disconnect both plaster layers and use a paper band prior to painting the wall. There is high risk of not achieving the performance if both plaster finishes are connected, or if a moulding connects the ceiling and the wall.

Services such as electrical installations, plumbing and often heating pipes are usually located in chases performed in the light ceramic walls. It is vital

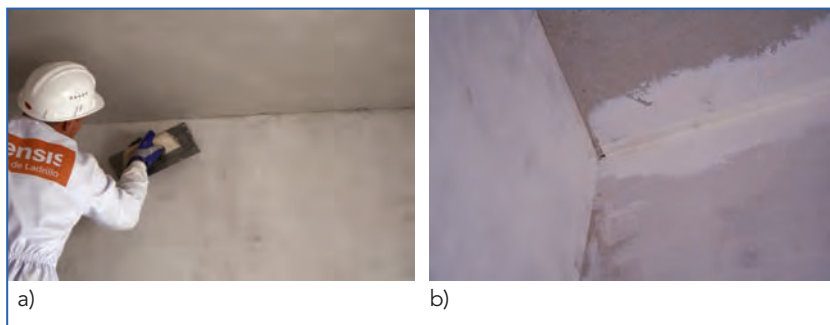


**Figure 25.7.** Example of Type 2 separating wall. Cavity wall.

a) Plan view of junction between separating wall and façade. b) Junction with floor.



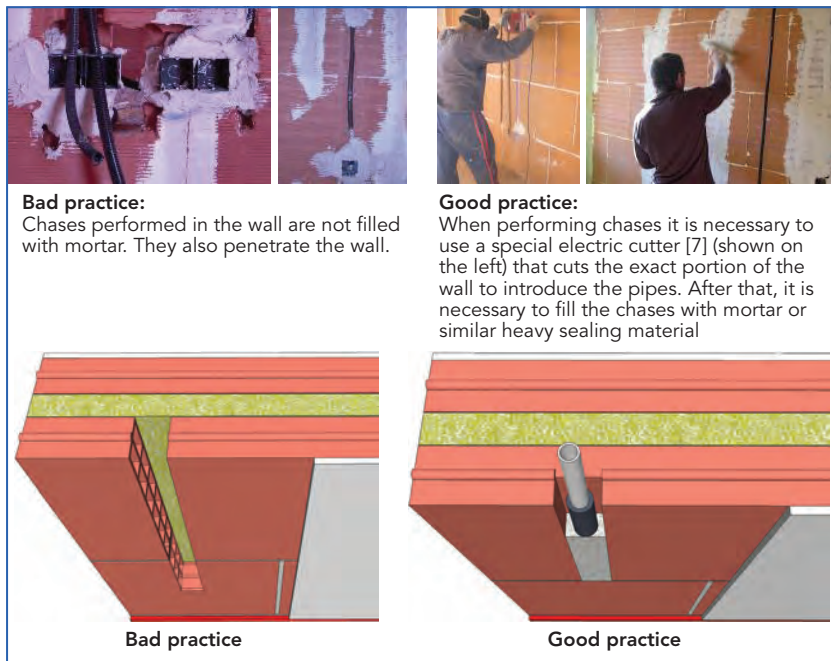
**Figure 25.8.** Detail of disconnection between the plaster finish of the wall and the plaster finish of the floor.



**Figure 25.9.** a) A worker usually performs a cut with a trowel in the plaster finishes.  
b) After that, building paper is used before painting both surfaces.

that the chases are filled with mortar so that they do not affect sound insulation. Figure 25.10 shows an example of good and bad practices.

Another situation which gives rise to poor sound insulation is back to back electric boxes. It is necessary to offset the electric boxes when they are located on both sides of the separating wall.



**Figure 25.10.** Examples of good and bad practice related to chases in light brick walls.

### Type 3. Steel framed walls with absorbent materials

Although they are not as traditional as masonry walls, metal framed walls are increasingly being used in Spanish buildings for different reasons, some of which are:

- Fast and dry installation. As opposed to the masonry walls, there is no need to apply a plaster coating to make the surface flat.
- Good global sound reduction index similar to cavity masonry walls, but they are narrower in width. They are usually 150 - 190 mm wide.

Type 3 walls are two leaf gypsum based board walls, consisting of two 12,5 mm plaster boards screwed directly to double metal studs. Absorbent material batts must be placed between the studs. Typical studs are 48 mm or 70 mm. Depending on the height of the room and type of stud, the studs must be tied to ensure structural safety, which results in a decrease in sound insulation of 8 dB [8]. In this way, it is important to seek the advice of the manufacturer or consultant to define the best profile and the best sound reduction

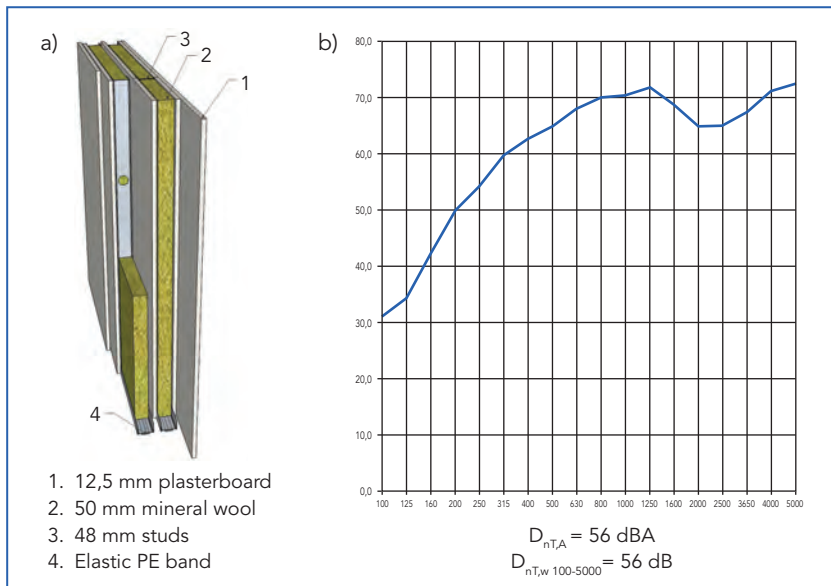


Figure 25.11. a) Example of Type 3 separating wall. Framed walls with absorbent materials. b) Typical airborne sound insulation.

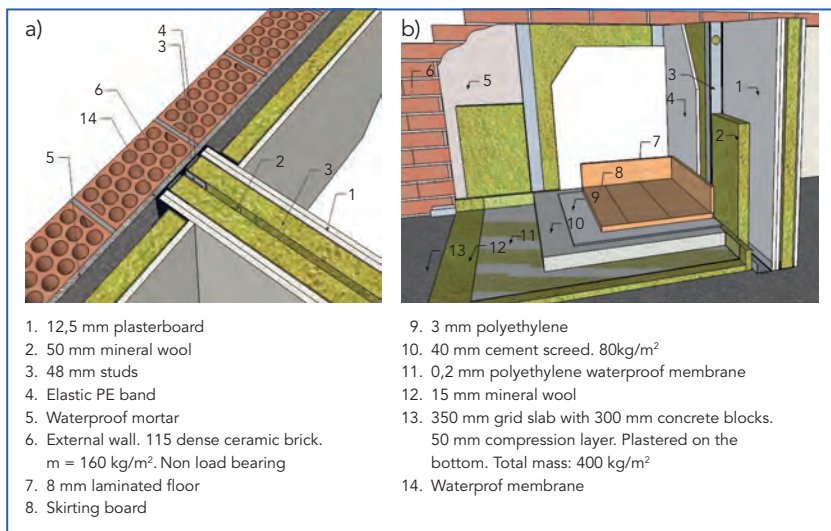
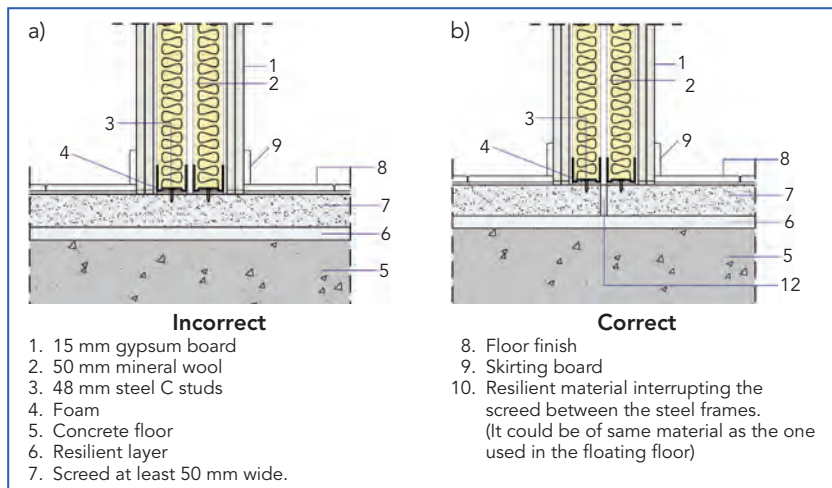


Figure 25.12. Example of Type 3 separating wall. a) Plan view of junction between separating wall and façade. b) Junction with floor.



**Figure 25.13.** Floor junction of a steel frame wall. a) Incorrect. The floor bridges the steel frames. b) Correct junction: a joint is performed between both frames [9].

performance. Figure 25.11 shows typical performance of a double stud wall and figure 25.12 shows typical junctions details.

When double stud walls are screwed to the top of the cement screed, it is vital to break the continuity of the screed between the panels. If a screed gap is not formed between them, a reduction of 7 dB is likely, resulting in failed tests. See figure 25.13.

Electrical boxes are usually a serious source of sound leaks, since they are usually made of plastic and have many holes. To maintain sound insulation it is necessary to use specific electrical boxes adapted to gypsum boards. It is also necessary to avoid back to back electric boxes. Offsetting them is an option.

### 25.3.2. Separating Floors

As previously mentioned, beam and block floors and grid floors are the most common. Floor blocks can be either ceramic or light aggregate concrete. Surface mass is 350 kg/m<sup>2</sup> on average.

The best way to control impact noise is using a floating floor consisting of at least 50 mm cement screed and a resilient layer. Typical resilient layers are:

- 20 mm mineral wool
- 5 mm polyethylene
- 20-30 mm EEPS



On top of the floating floor the floor finish is installed. Wooden floors or tiles are the most usual. See figures 25.14, 25.15, 25.16 and 25.17.

Flanking strips have to be used at the perimeter to avoid flanking structure borne sound. The plinth or skirting board is often rigidly attached to the wall, connecting the wall and the floating floor simultaneously. This could lead to a decrease of several dB in sound insulation. Instead, an elastic sealant should be placed in the joint between the skirting board and the floor, such as silicone. See figure 25.18.

When higher performance is required, a suspended ceiling consisting of 15 mm gypsum based board screwed to metal channels and 50-70 mm mineral wool infill has to be installed, that is the case of plant rooms or activity rooms.

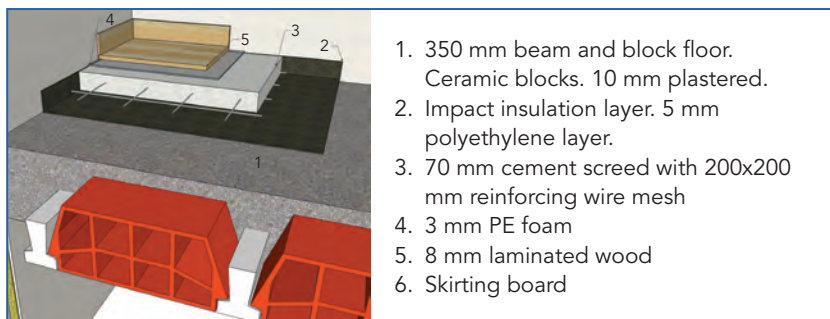


Figure 25.14. Example of a typical Spanish floor. Beam and block floor with a floating floor consisting of a screed on a polyethylene layer.

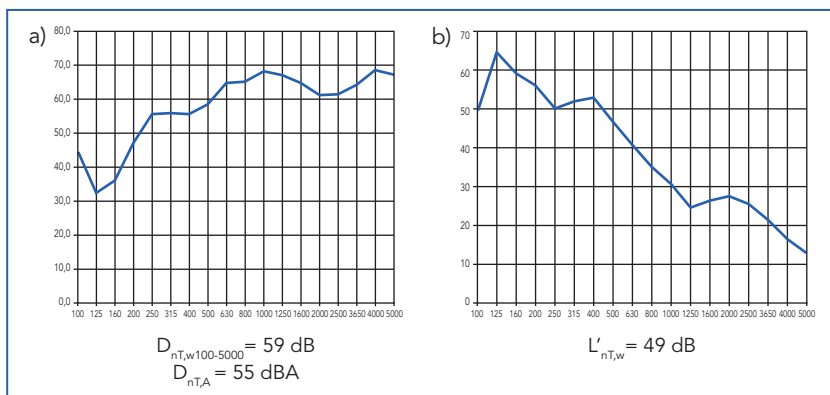
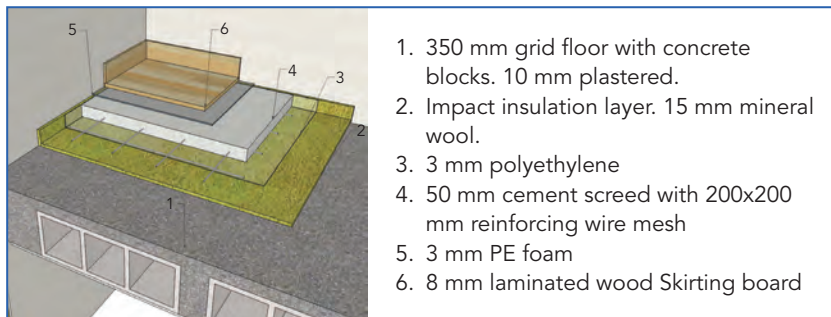
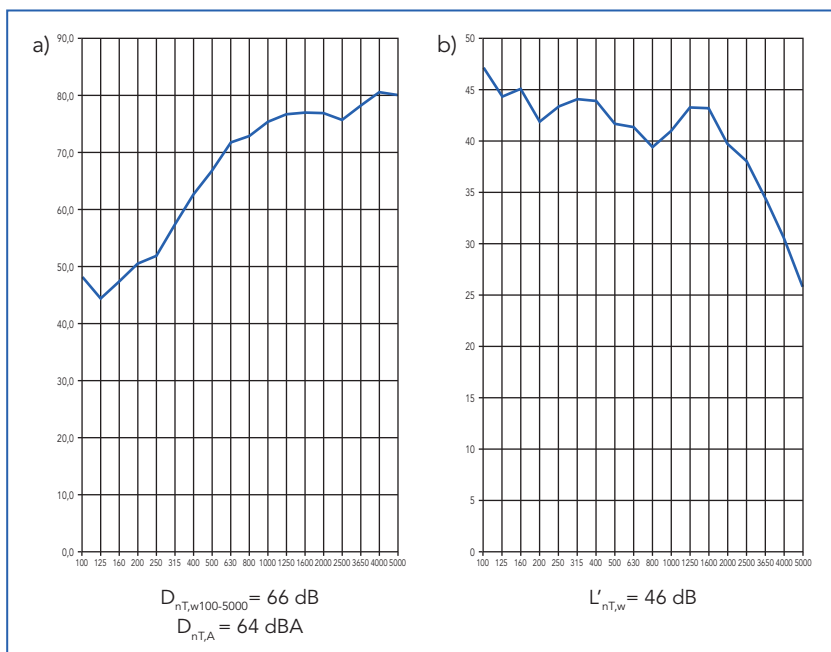


Figure 25.15. Performance of separating floor shown in figure 25.14. a) Airborne sound insulation b) impact sound insulation.



**Figure 25.16.** Example of a typical Spanish floor.

Grid floor with a floating floor consisting of a screed on mineral wool.

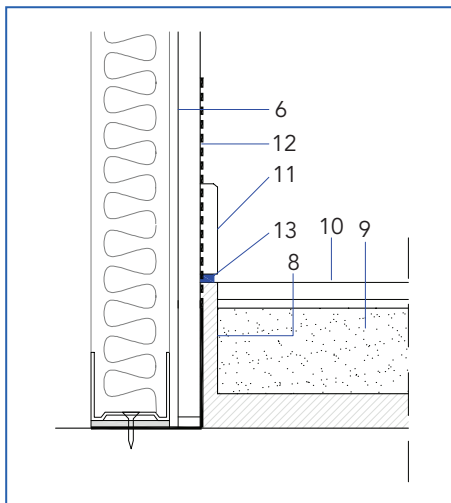


**Figure 25.17.** Performance of separating floor shown in figure 25.16.

a) Airborne sound insulation b) impact sound insulation.

### 25.1.3.3. Special features

Some noise problems are related to noise from building services and equipment, especially airborne and structure-borne sound coming from



**Figure 25.18.** Junction detail of skirting board and floating floor. Example taken from the Spanish acoustic application guidelines. DB HR Application Guide [9].

bathrooms and kitchens located upstairs. It is common practice that drainage pipes penetrate the floor and run along the bathroom located downstairs (see figure 25.19), thus being a major source of disturbance, especially at night.

Rigid connections between the pipes and the walls and the floor, a lack of lagging of the pipes and/or an inappropriate ceiling result in both airborne and structure-borne transmission to the premises downstairs.

All plumbing components must be isolated from the building structure. A resilient material such as fiberglass or polyethylene must be used wherever the pipes penetrate walls and floors. In addition, it is vital to seal the perimeter of any penetration with caulking.

Whenever water pipes are kept in chases, it is vital that they are insulated with a resilient material such as foam. Pipe hangers must have rubber pads.

Drainage pipes must be multilayer pipes or be insulated to avoid airborne noise. The ceiling must be a suspended one with an acoustic absorbent material in the cavity and be acoustically sealed in its perimeter.

All fixtures must be set on resilient pads, especially the bathtub and shower pan to avoid the radiation of water splash noise.

**Bad practice**

Chases performed in the wall are not filled with mortar. Foam lagging is missing in the water pipes that run above the ceiling. Water pipes in contact with the brick wall, transferring structure-borne noise to the wall.

**Good practice**

Water pipes have a foam lagging. When they penetrate the wall, caulking is used to seal their perimeter.

**Bad practice**

Typical bottle trap used in for the appliance drainage. It hangs from the bottom of the slab. Noise due to water flow can be heard in the underlying premises. The gap between the trap and the slab has not been properly sealed.

$L_{A,eq100-10000} = 37,4$  dBA measured in the underlying premises when a suspended ceiling was installed. [10]

**Good practice**

Glass fibre insulation is used for lagging pipes. After installing a suspended ceiling, the noise emitted due to water flow from the shower decreased in 5 dBA.

$L_{A,eq50-10000} = 32,5$  dBA measured in the underlying premises.

**Figure 25.19.** Example of drainage pipes hanging from the bottom face of the floor.

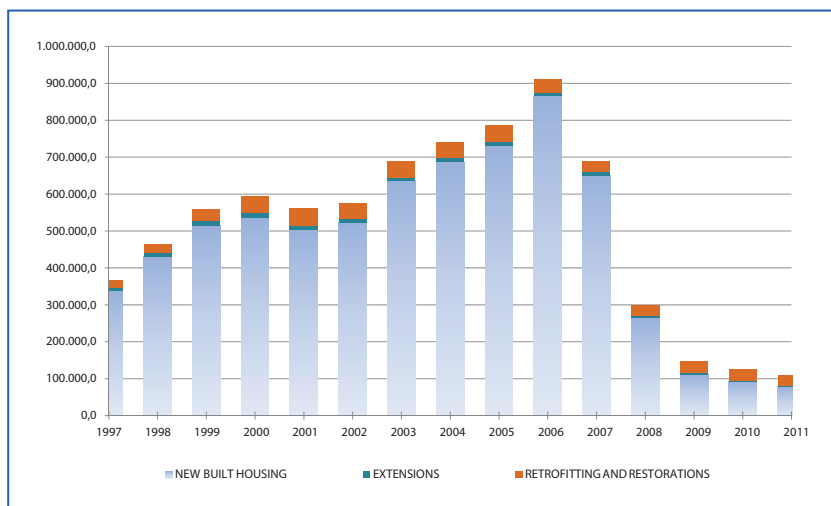
## 25.4. Existing Houses

Due to the current economic situation, most building companies are focussing on refurbishments, but most works in existing housing are not being undertaken for acoustic reasons. Conservation works, energy savings



and barrier free design are the most important reasons for retrofitting the housing stock, partly due to the funds given by some administrations [11] to works aiming at increasing the energy efficiency and removing architectural barriers. Nevertheless, works in existing buildings can be an opportunity to upgrade the poor acoustics of the existing housing stock.

According to the INE (National Statistics Institute), the number of existing dwellings being retrofitted and in 2011 was 28,500. Figure 25.20 shows the number of dwellings that are retrofitted per year, in comparison with the new built houses.

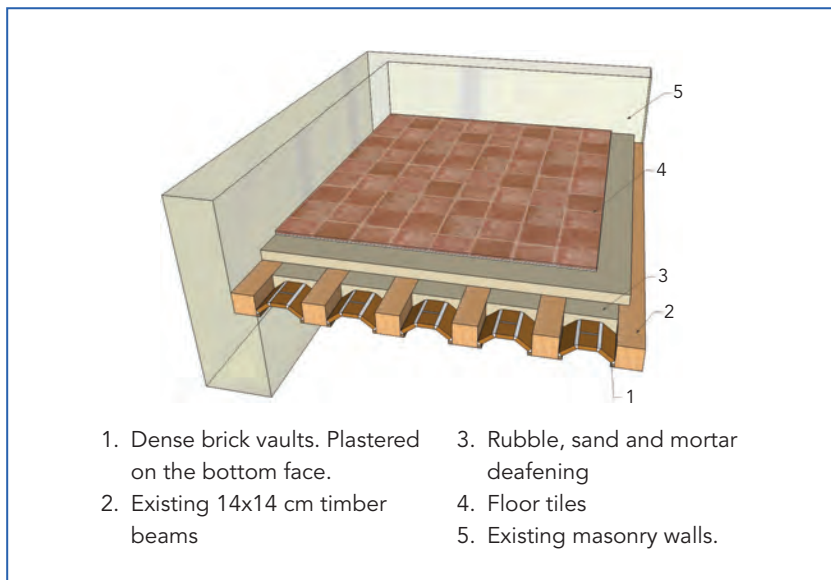


**Figure 25.20.** Works in existing housing in comparison with new build houses.

Next section explains the typical housing constructions found in Spain and its performance. An example of a retrofitting is also given.

#### 25.4.1. Typical constructions found in existing stock

Early 20<sup>th</sup> century buildings in Spain were basically composed of a series of thick loadbearing walls which supported the internal floors and roof. Separating floors used to consist of a series of timber beams [12], laid every 40 cm in average. The space between the beams was often filled with a mixture of rubble, sand and plaster, forming little vaults. Bricks were also used for that purpose. On top of the various series of rubble layers, the floor finish was installed, which was usually tiled or wooden. See figure 25.21.

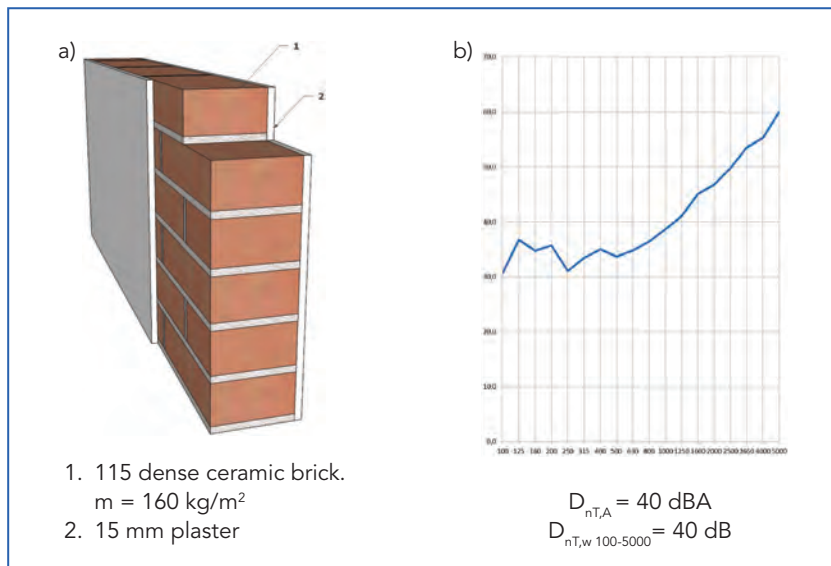


**Figure 25.21.** Typical floor dating 1900's. It is composed of a series of wooden beams, 14x14 cm in average. Bricks were laid between the wooden beams forming a vault and a rubble infilling was placed on top. The floor was tiled or wooden.

Walls were massive and could be made of stone blocks, adobe, bricks or timber frame walls with some brick infilling, they were often wider than 250 mm, but this depended on which storey they were built, as the wall width usually decreased with the height of the building.

It was in the 1940's [13] when concrete became popular in Spain and it started to be used widely in houses. At first, it was only the floors which were made of concrete beams and light ceramic or plaster blocks. They commonly rested on load bearing brick walls. In this period, typical walls are 250 mm or 125 mm solid brick walls, plastered on both faces. See figures 25.22 and 25.23.

It is in this period when Modern Movement principles, such as the free plan, became very popular among architects. The idea that the partitions and the façade did not have a structural function was very attractive and in the 1960's buildings were composed of a grid structure, formed by pillars and slabs, where walls often filled the gaps left by the structure. Walls lost their structural function and the tendency was to make them lighter and



**Figure 25.22.** Example of typical construction from 1950's in Spain. a) 115 mm dense ceramic brick. b) Typical airborne sound insulation [14].

thinner, which carried the negative effect that sound insulation was worsened [15]. Typical separating walls of this period are big brick blocks, 70 or 100 mm, plastered on both faces.

It was 1981 when the first regulation on sound protection came into force. The sound reduction index then was set to be  $R_{A} \geq 45 \text{ dBA}$  and the maximum normalized impact sound pressure level was  $L_{n,A} \leq 80 \text{ dBA}$  (low impact insulation).

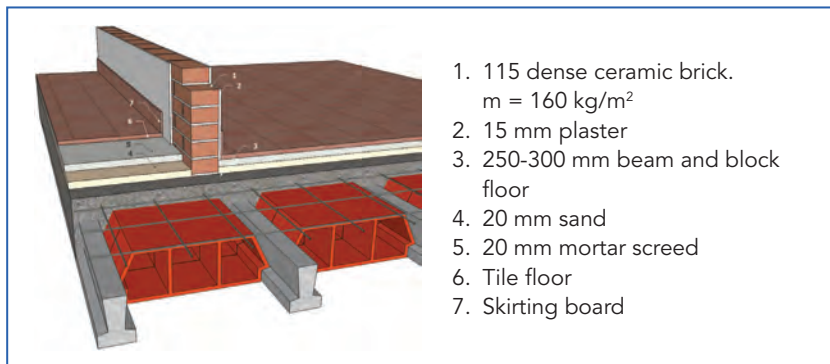
The two typical walls of this period, from 1981 to 2009, were the following:

- Cavity wall formed by two 70 mm hollow ceramic walls,  $70 \text{ kg/m}^2$  each, rendered on both faces, thus resulting in a cavity wall 210 mm wide. The cavity could be filled with mineral wool or not. Typical sound reduction index for this wall is  $R_w + C = 48 \text{ dB}$ .
- 115 solid ceramic brick wall, plastered on both faces. Typical sound reduction index for this wall is  $R_w + C = 45 \text{ dB}$ . Similar to the one shown in Figure 25.22.

As for the floors, typical concrete floors were beam and block floors, 250 mm wide, 60 – 70 cm span. A sand layer and a mortar screed were poured



before laying the floor finish. Floors usually weighed more than  $300 \text{ kg/m}^2$ , which resulted in an acceptable airborne sound insulation, but as there was no elastic layer between the floor finish and the structure, the impact insulation was commonly very poor, becoming a major cause of disturbance. See figure 25.23



**Figure 25.23.** Example of typical construction from 1950's in Spain. Floor and separating wall. As it can be seen, no impact insulation layer was installed.

As mentioned in section 25.1.1, the current regulation was approved in 2009 and "new constructions" have already been described in section 25.1.3.

#### 25.4.2. Retrofitting Example

This part provides an example of a traditional Spanish floor, which has been retrofitted [16]: The building dated back more than a hundred years and did not meet the functional, comfort and structural needs.

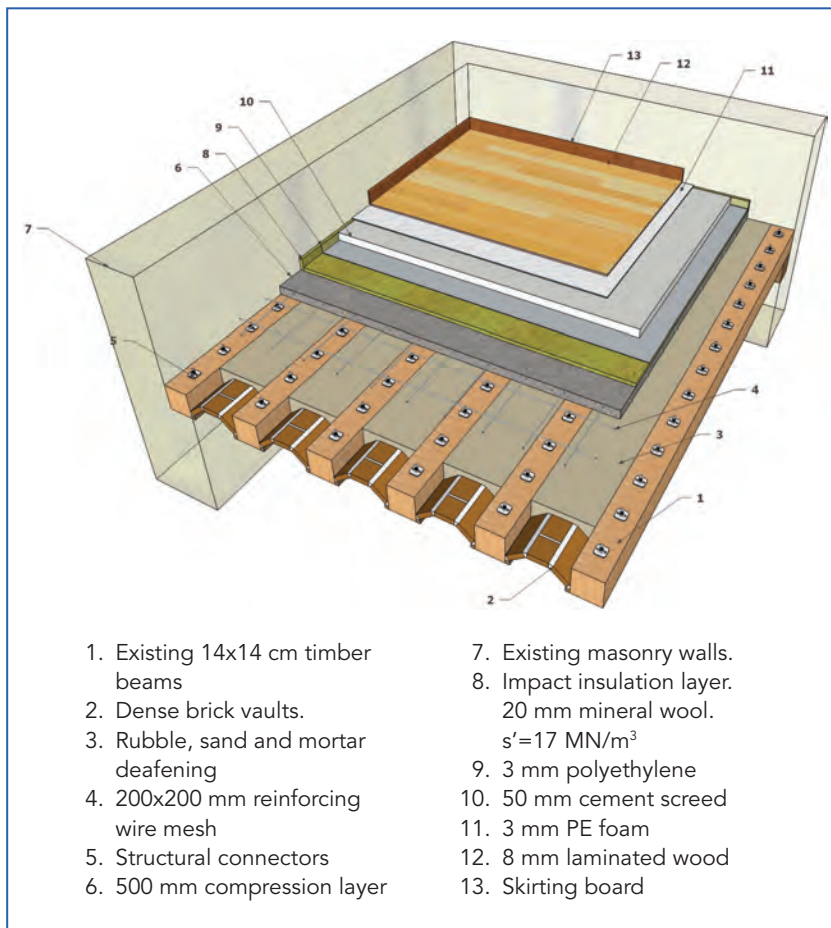
The structural system was formed by load bearing stone blockwalls and timber floors consisting of  $14 \times 14 \text{ cm}$  timber beams, separated 400 mm. Brick vaults filled the gaps between the timber beams. There were several layers of rubble and sand on top of the vaults. See Figure 25.21.

The old floors had serious problems relating to excessive deflections. For that reason, the layers of rubble were removed, the timber beams were reinforced with connectors and a 50 mm reinforced concrete slab was laid. That allowed the existing timber beams to be preserved. On

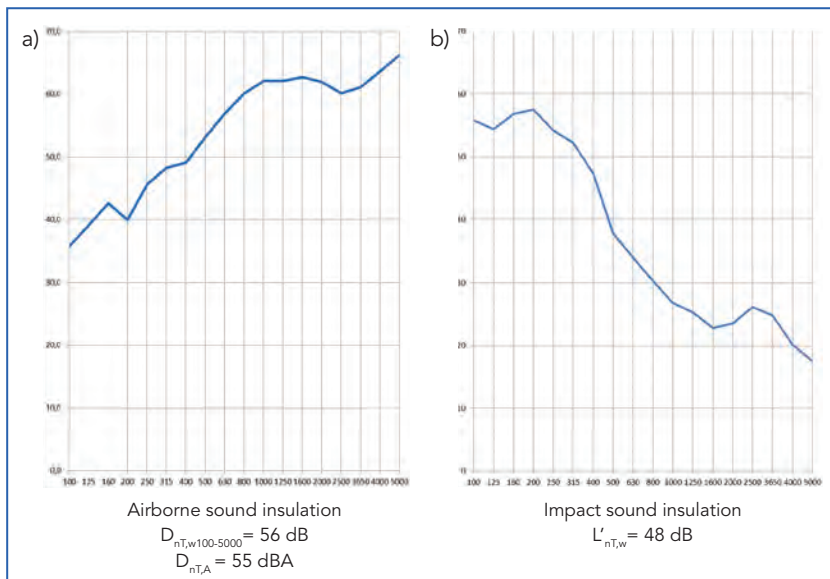




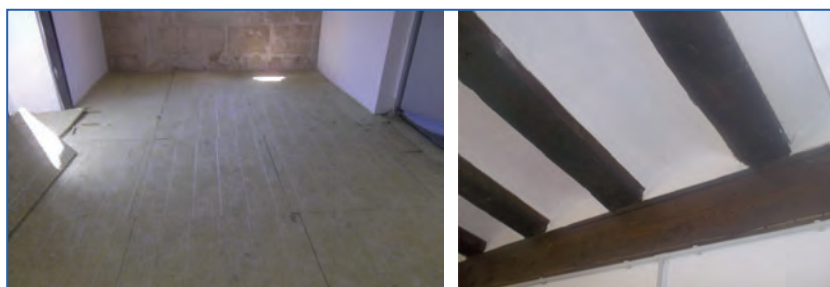
top of the concrete slab, a floating floor was installed as shown in the picture. The increase in airborne and impact sound insulation was 9 dB and 32 dB respectively. Figure 25.26 shows the appearance of the bottom face of the floor. It was an aesthetic requirement to see the timber beams.



**Figure 25.24.** Example of a retrofitted timber floor. Timber beams and the brick vaults were maintained. Part of the infilling was removed. Structural connectors and a 50 mm compression layer were installed before the floating floor.



**Figure 25.25.** Airborne and impact sound insulation of the floor shown in figure 25.24.



**Figure 25.26.** Left. Image of the construction of the floating floor. Note that the flanking strips are missing in this image. Right, view of the bottom face of the floor after the retrofitting.

## 25.5. Acknowledgments

Special thanks to the Ministry of Infrastructures for funding and supporting research on sound insulation in existing housing done by the Quality in Construction Unit, in Eduardo Torroja's Institute. Also, special thanks to Hispalyt (Spanish association of brick and tile manufacturers), ATEDY

(Spanish technical association of plaster and gypsum manufacturers) and AFELMA (Spanish association of mineral wool manufacturers) for their contribution.

## 25.6. References

- [1] 2011 Population and Housing Census. Instituto Nacional de Estadística. (National Statistics Institute [www.ine.es](http://www.ine.es))
- [2] Building Statistics. 2012. First half by Consejo Superior de Colegios de Arquitectos de España, CSCAE (Spanish Council of Associations of Architects) [http://www.cscae.com/index.php?option=com\\_wrapper&view=wrapper&Itemid=221](http://www.cscae.com/index.php?option=com_wrapper&view=wrapper&Itemid=221)
- [3] Norma Básica de la Edificación NBE CA 88 de condiciones acústicas de los edificios.
- [4] Document DB HR Protection against noise. [www.codigotecnico.org](http://www.codigotecnico.org)
- [5] Machimbarrena, María; Carrascal, Teresa; *"The Spanish Acoustics Building Code (DB HR) and its first year of application"*. 2<sup>o</sup> Convention Nazionale del Gruppo di Acustica Edilizia. Firenze. 2010.
- [6] Spanish Noise Law: Ley 37/2003, de 17 de noviembre, del Ruido.
- [7] Hispalyt. Manual de ejecución de fábricas de ladrillo para revestir. [http://www.silensis.es/reportaje.asp?id\\_rep=333](http://www.silensis.es/reportaje.asp?id_rep=333)
- [8] Guía de Soluciones Constructivas con placa de yeso laminado y lana mineral para el cumplimiento del CTE. Noviembre de 2012. ATEDY\_AFELMA\_IETcc. [http://www.aislar.com/documentos%20enlazados/Nueva\\_Guia%20Soluciones%20Constructivas%202012.pdf](http://www.aislar.com/documentos%20enlazados/Nueva_Guia%20Soluciones%20Constructivas%202012.pdf)
- [9] DB HR Application Guide [http://www.codigotecnico.org/web/recursos/documentosadicionales/complementarios/texto\\_0011.html](http://www.codigotecnico.org/web/recursos/documentosadicionales/complementarios/texto_0011.html)
- [10] "Estudio 1. Ruido generado por la descarga de una cisterna y atenuación proporciona por una cisterna y atenuación proporcionada por material de lana mineral en una situación de obra real. Proyecto BALI (Building Acoustics Living) "Diseño integral de sistemas y edificios eficientes acústicamente en un entorno saludable". Financiado por el Ministerio de Ciencia e Innovación (MICINN) y Fondos para el Desarrollo Regional (FEDER).
- [11] Ley 8/2013, de 26 de junio, de rehabilitación, regeneración y renovación urbanas.
- [12] Monjó Carrió, Juan; Maldonado Ramos, Luis. "Patología y técnicas de intervención es estrucutras arquitectónicas". Ediciones Munilla-Lería, Madrid, octubre 2001.

- [13] Paricio Ansuategui, Ignacio. "La fachada de ladrillo". Bisagra, 2000.
- [14] Carrascal García, M<sup>a</sup> Teresa; Romero Fernández, Amelia; Casla Herguedas, M<sup>a</sup> Belén. "Efectos de la unión entre trasdosados cerámicos y la fachada en el aislamiento acústico a ruido aéreo". Jornadas internacionales de Investigación en la Construcción. Instituto de Ciencias de la Construcción Eduardo Torroja. Madrid, 21 y 22 de noviembre.
- [15] Carrascal García, M<sup>a</sup> Teresa, Casla Herguedas, M<sup>a</sup> Belén; Romero Fernández, Amelia. "Rehabilitación acústica". 4<sup>o</sup> Congreso de patología y rehabilitación de edificios. Santiago de Compostela. Abril 2012.
- [16] Romero Fernández, Amelia; Carrascal García, M<sup>a</sup> Teresa; Muzio, Giovanni. "Aislamiento acústico de forjados de madera en la rehabilitación de un edificio histórico." Tecniacústica 2013. Valladolid.
- [17] <http://www.costtu0901.eu/>
- [18] [http://w3.cost.esf.org/index.php?id=240&action\\_number=TU0901](http://w3.cost.esf.org/index.php?id=240&action_number=TU0901)



# Building acoustics throughout Europe

## Volume 2: Housing and construction types country by country

# 26

## Sweden

Authors:

K. Larsson<sup>1</sup>

K. Hagberg<sup>2</sup>

C. Simmons<sup>3</sup>

<sup>1</sup> SP Technical Research Institute of Sweden

<sup>2</sup> WSP

<sup>3</sup> Simmons Akusik & Utveckling



## CHAPTER

## 26

## Sweden

## 26.1. Design and acoustic performance

### 26.1.1. Overview of housing stock

In this chapter information on the population, building typology and quantity of housing stock is reported. Most of the data were taken from SCB [1] (Statistics Sweden); Boverket [2] (The Swedish National Board of Housing, Building and Planning) and also Wikipedia [3].

#### *The quantities of housing stock and total population*

Although Sweden covers a relatively large surface area on a European scale, it is one of the countries with lowest density when it comes to population. Sweden has just over 9,6 million inhabitants (July 2013, [1]) on a surface area of approximately 450 000 km<sup>2</sup>, which gives a population density of 21 inhabitants per square km. The population density is higher in the southern part of the country and lower in the northern parts. The urbanisation in Sweden is high and about 85% of the population live in urban areas.

In Sweden residential buildings are classified in two main categories; small houses and multi-family houses. A so called small house is categorised as a building for 1 or 2 families, either as a detached or semi-detached house. A building with 3 or more apartments is classified as a multi-family house. Based on publicly available data from Statistiska centralbyrån (SCB, Statistics Sweden [1]) and from Boverket (The Swedish National Board of Housing, Building and Planning [2], [4]), there are about 4,5 million homes in Sweden. Among these, approximately 2 million are in small houses (detached or semi-detached houses), and 2,5 million apartments in multifamily houses. In total there are approximately 165 000 multi-family houses and 1 888 000 small houses. More than half of the population lives in small houses. Figure 26.1 shows the development of the Swedish housing stock since 1990.

The number of new build houses varies much over the years. In 2007, 20 700 apartments were built in Sweden, while in 2010 the number was reduced to only 12 000. The annual average in the years 2000–2010 was 15 000. When it comes to small houses (single or two family), 9 700 were

built in 2007, which was reduced to only 7 500 in 2010 mainly because of the economic situation. The annual average between 2000 and 2010 in single family houses were 7 700, according to the same source. At the time of writing there is a common view that there are too few apartments built in Sweden and that there is a lack of available apartments, especially in the larger cities. It is expected that the number of residential houses built annually will increase substantially in coming years.

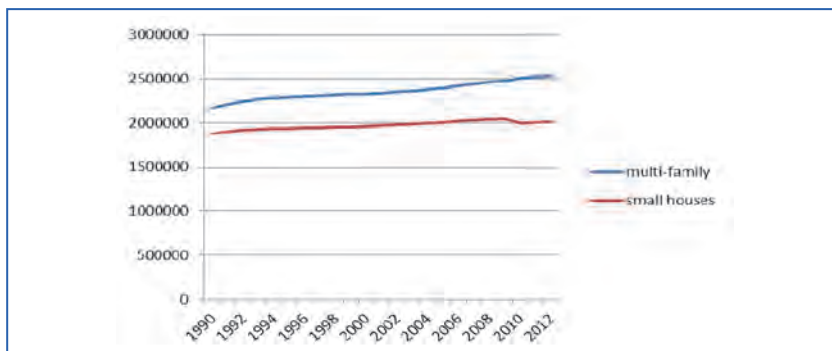


Figure 26.1. Number of homes in multi-family and small houses (1-2 families) respectively.

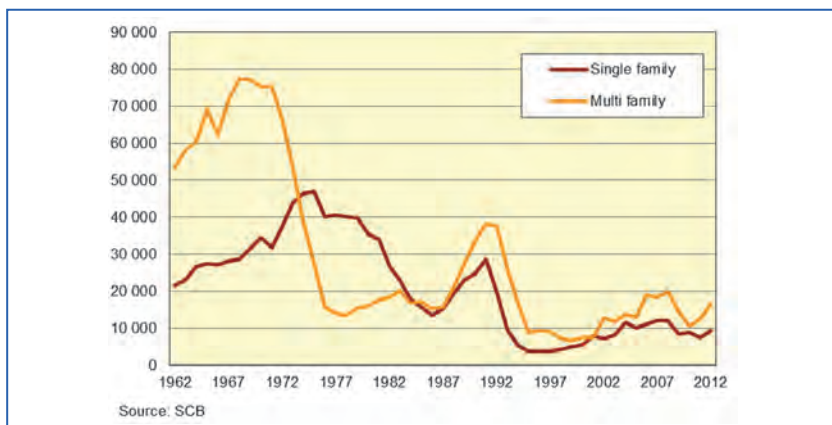


Figure 26.2. Number of new build homes in multi-family houses and small houses (single-family houses) between 1962 and 2012.

Examples of typical Swedish residential building types are shown in figures 26.3a-26.3d.



a) Detached house and multi-family house 1930-1940.



b) Multi-storey apartment buildings 1940 (left) and 2000 (right).



c) Multi-storey apartment buildings 1950-1960.



d) Attached (row) houses 1970-1980 (left) 2000 (right).

**Figure 26.3.** Examples of typical residential building types in Sweden.  
(Photographs are taken during the winter season).



### *The most populated cities*

The most populated cities in Sweden are [1,3] Stockholm (1,4 million), Göteborg (0,53 million) and Malmö (0,31 million). This means that 23% of the population lives in the 3 largest cities. If including the larger suburb areas, almost 40% of the population is living in the urban areas close to the largest cities. There is also a strong trend of urbanisation and the largest cities are growing in population. It is expected that the number of new build houses will increase substantially in coming years.

### **26.1.2. New build housing constructions**

#### *The enforced legislation in building acoustics*

The national requirements for building acoustics can be found in the Swedish building code (BBR) [5] issued by Boverket (The Swedish National Board of Housing, Building and Planning). In 1994 the building code went through a major revision, and the requirements were reformulated into functional requirements instead of the previous prescriptive requirements. In order to simplify for contractors and developers to fulfil the regulations a sound classification system was introduced and implemented in a national Swedish standard for residential buildings (SS 25267, [6]). The system was introduced in its first version in 1996, and has been revised regularly since then. It has also been extended with some amendments. According to the standard, the acoustic properties can be classified in 4 different classes, A-D, where A corresponds to the highest acoustic performance, while class D should be used in cases where the minimum acoustic requirements cannot be fulfilled for example because of cultural heritage or technical limitations. According to the building code, the building acoustics requirements were fulfilled if sound class C according to the sound classification standard was met. Recently, in 2013, the building code was revised again and instead of referring to the standard for the minimum requirements, numerical values of building acoustic requirements are now listed in the building code. However, the revision aimed at preserving the minimum requirements at the same level as before, and only put the figures directly into the building code. For better acoustic performance than the minimum requirements, the building code still refers to the sound classification standard, where class A or class B can be selected. At the time of writing the national sound classification standard (SS 25267) is being revised in order to adapt to the new building code.

The Swedish building code prescribes the following minimum requirements for building acoustics in new built houses.

- Airborne sound insulation between dwellings:  $D_{nT,w} + C_{50-3150} \geq 52$  dB
- Impact noise insulation between dwellings:  $L_{nT,w} + C_{150-2500} \leq 56$  dB
- Total equivalent sound pressure level from building service equipment
  - Bedrooms and living rooms:  $L_{pAeq,nT} \leq 30$  dB,  $L_{pAFmax,nT} \leq 35$  dB
    - in bedrooms also  $L_{pCeq} \leq 50$  dB
- Traffic and other outdoor noise sources (indoor level)
  - Bedrooms and living rooms:  $L_{pAeq,nT} \leq 30$  dB,  $L_{pAFmax,nT} \leq 45$  dB

The requirement on maximum level from traffic noise concerns night (2200 – 0600) levels and should not be exceeded more than 5 times during the night, and never by more than 10dB.

In addition the requirements on low frequency noise according to Table 26.1 from Socialstyrelsen (The National Board of Health and Welfare, 2013 [7]) has to be fulfilled in bedrooms and living rooms.

*Table 26.1. Additional requirements on low frequency noise.*

Third octave band (Hz)	Sound pressure level (dB)
31,5	56
40	49
50	43
63	41,5
80	40
100	38
125	36
160	34
200	32

Beside these limits, additional requirements apply in various situations such as if there are audible tones in service equipment noise, or requirements on reverberation time in stairwells.

The requirement on facade sound insulation is very much determined by the outdoor traffic noise level. The requirement is for the resulting indoor level,



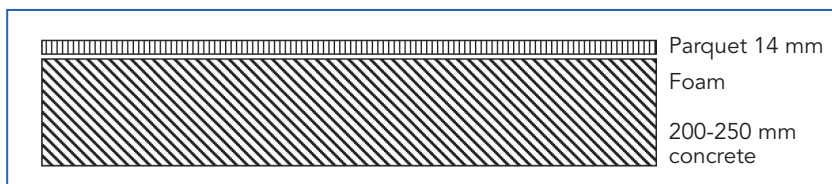
and the facade insulation has to be designed in relation to that. In Boverkets handbook [8] there are guidelines for designing façade sound insulation.

Since the spectrum adaptation term  $C_{50-3150}$  are included in the descriptors, the Swedish requirement on building acoustic performance cover the frequency range down to 50 Hz.

### Typical heavyweight constructions

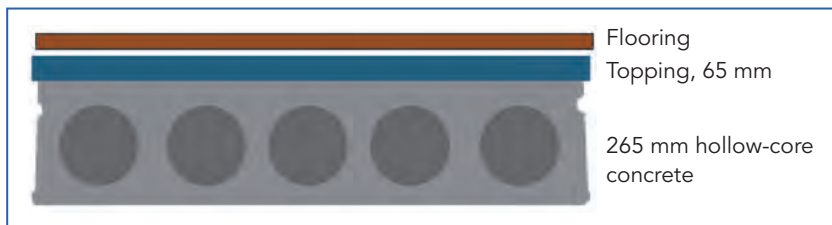
#### Floors

For heavy weight multi storey buildings mainly 2 types of constructions are used. Either on-site cast homogeneous concrete, or prefabricated hollow core concrete slabs. A typical design of a homogenous floor is shown below.



**Figure 26.4.** Example of on-site cast concrete floor.

For hollow core prefabricated slabs a typical example is shown below, HDF265 mm thickness with 65mm concrete topping and parquet flooring.



**Figure 26.5.** Example of prefabricated hollow core concrete slab floor.

The typical performance of these constructions is shown below. Both floors show typical performance of  $R'_w$  61 dB and  $R'_w + C_{50-3150}$  58-59 dB. However, the resulting sound insulation also depends on the type of flanking constructions and might differ. Typical impact noise level is  $L'_{n,w} = 49-50$  dB and  $L'_{n,w} + C_{150-2500} = 50 - 52$  dB.

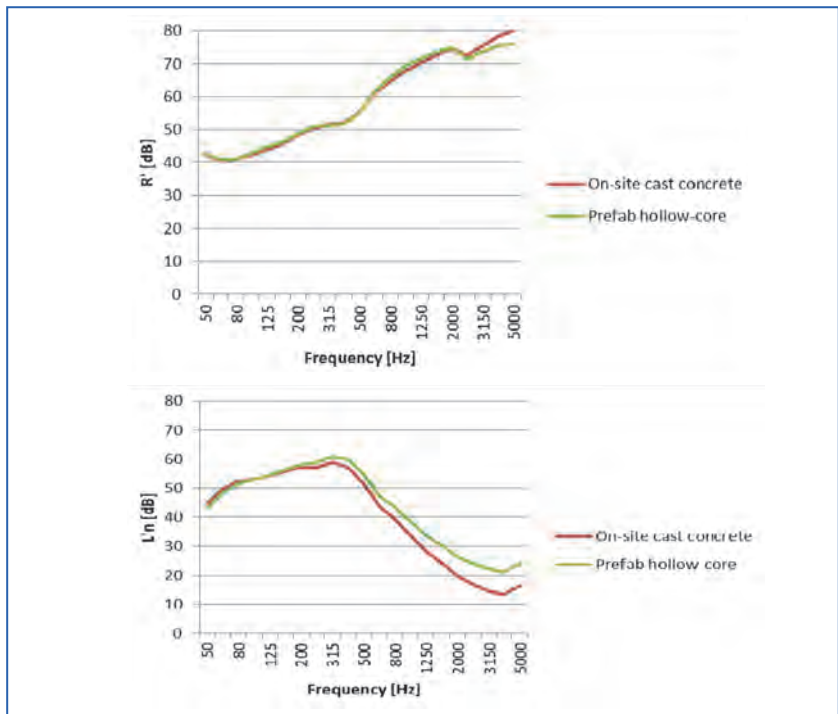


Figure 26.6. Typical airborne and impact noise insulation for typical heavy weight constructions.

### Façades and joints

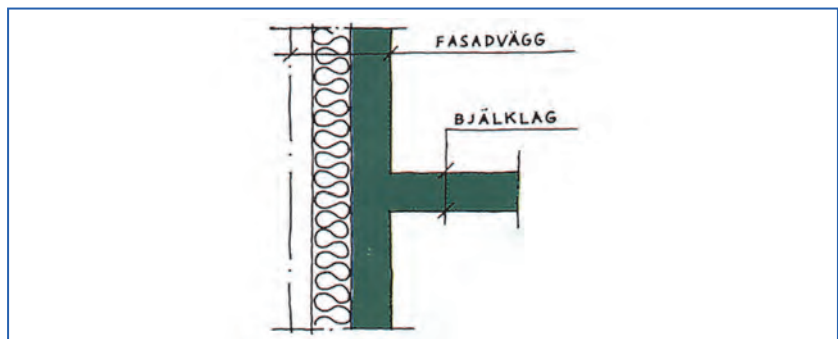
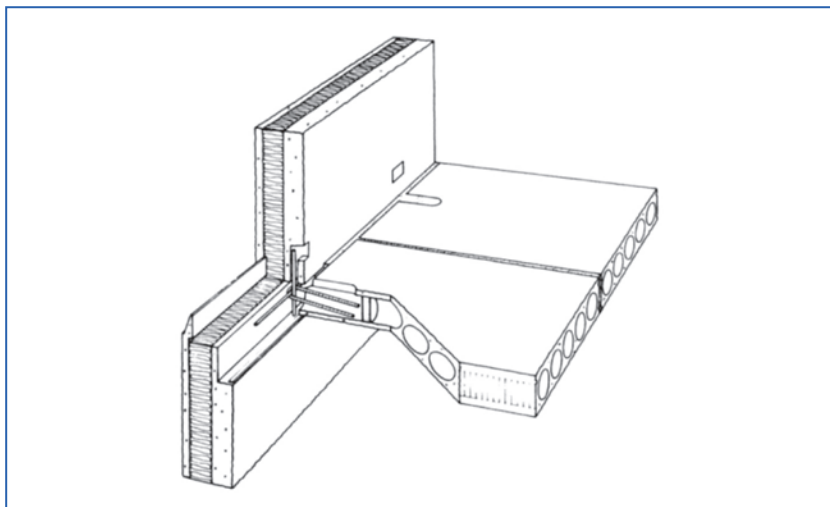


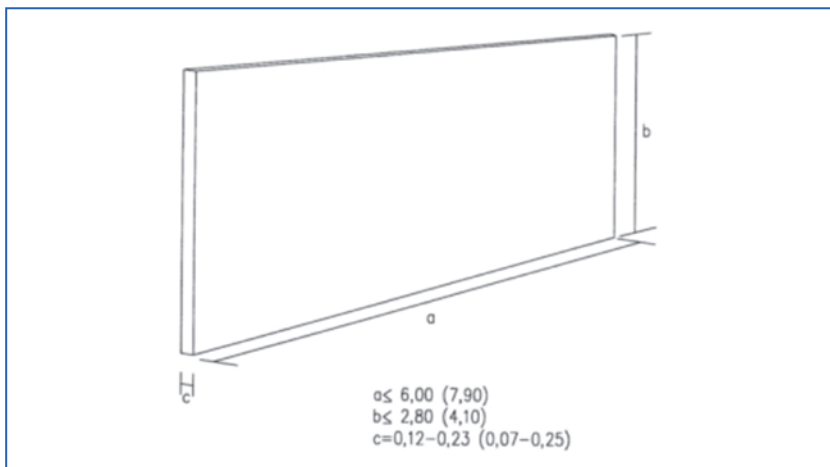
Figure 26.7. Typical heavy weight façade. From left to right of the wall: Plaster + thin concrete, 10-15 cm mineral wool, 10-15 cm concrete. Fasadvägg = façade wall, Bjälklag = floor.



**Figure 26.8.** Example of prefabricated hollow core concrete slab and a concrete sandwich façade element.

### Separating walls

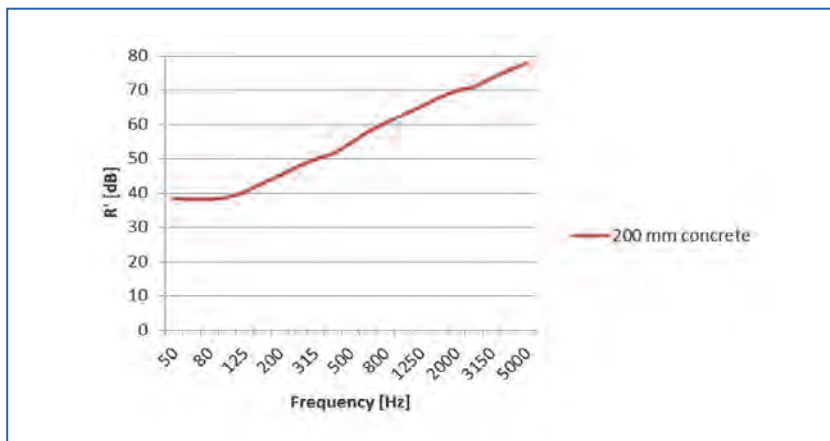
An example of a typical heavy weight separating wall is a 200 mm concrete wall cast on-site as illustrated in Figure 26.9.



**Figure 26.9.** Homogeneous on-site cast concrete separating wall.



The acoustical performance of the wall is shown in Figure 26.10 below.  $R'_w$  is typically 58 dB and  $R'_w + C_{50-3150} = 56-57$  dB.



**Figure 26.10.** Reduction index of a typical heavy weight wall.

### Typical lightweight constructions

An increasing proportion of the new build multi storey houses in Sweden are made using lightweight building techniques, mainly wooden constructions. There are several reasons for the increased interest in wood as a building material. Forests are an important natural resource in Sweden and there is a national strategy to increase the use of wood in the building sector. There are also environmental arguments to use renewable materials, as well as low weight for transportation. Development of wooden constructions has been strong for the last decade and solutions that fulfil the sound insulation requirements have been developed.

### Floors

An example of a typical lightweight floor is a timber joist floor with a heavy floating top floor and a resiliently suspended ceiling made of plasterboard (2 layers). Total thickness is approximately 450 mm. The performance of such a floor is  $R'_w$  60 dB and  $R'_w + C_{50-3150}$  52-54 dB. Impact noise levels are  $L'_{n,w}$  49 - 50 dB and  $L'_{n,w} + C_{150-2500} = 52 - 53$  dB (based on field measurements).

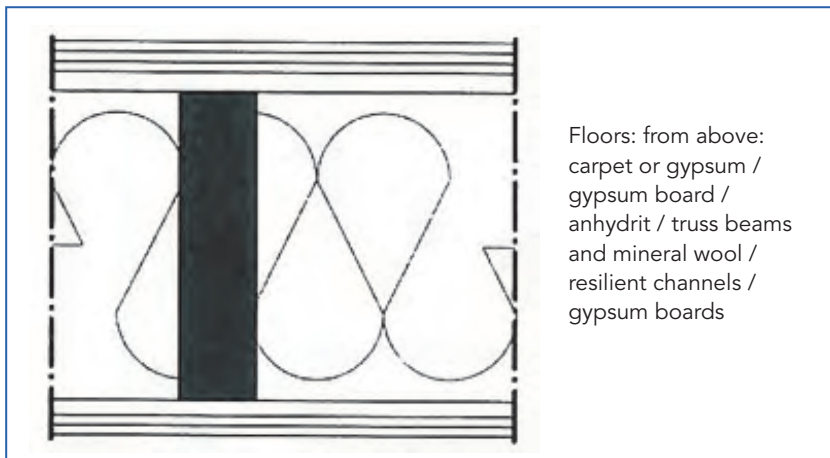


Figure 26.11. Example of a typical light weight timber joist floor.

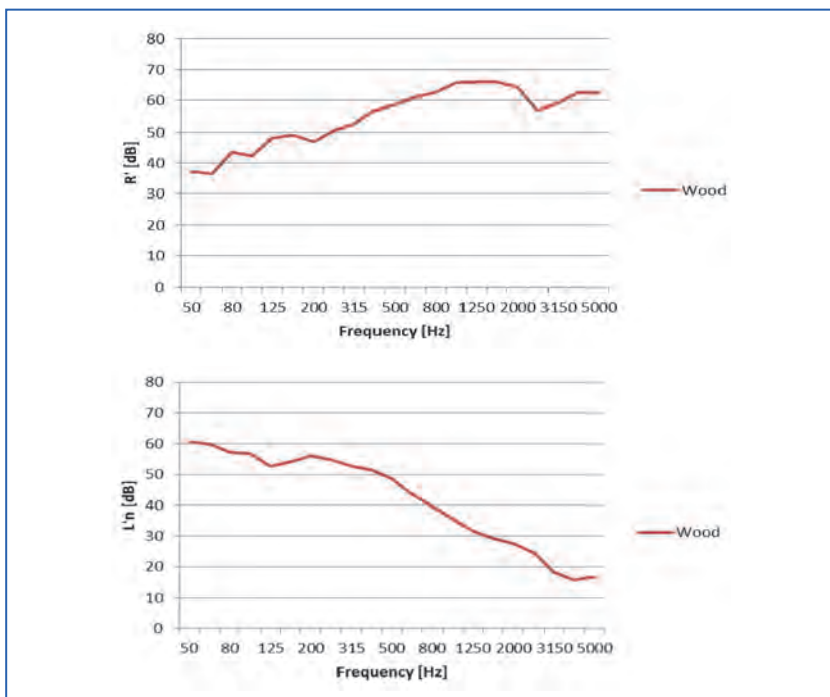
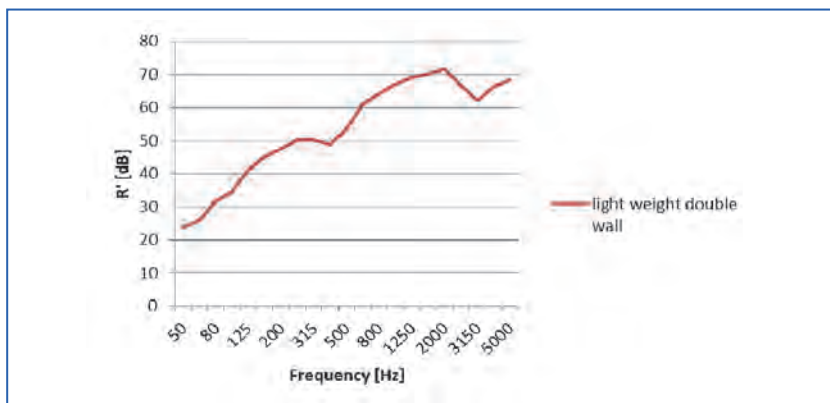


Figure 26.12. Typical acoustical performance of lightweight floor.



## Walls

Lightweight walls are based on double wall constructions mainly with multiple layers of gypsum boards on each side of separated studs. Both wooden and metal studs are used, with metal studs more common in multi storey buildings. The lightweight double wall constructions can also be used in combination with heavyweight floor constructions. Typical performance is  $R'_w$  60 dB and  $R'_w + C_{50-3150}$  55-56 dB.



**Figure 26.13.** Typical acoustical performance of lightweight gypsum wall.

### Typical errors in design and workmanship

The Swedish National Board of Housing, Building and Planning (*Boverket*) has published a handbook [8] (in Swedish) where some of the most common errors are described.

The most common errors in the workmanship giving problems with sound insulation is:

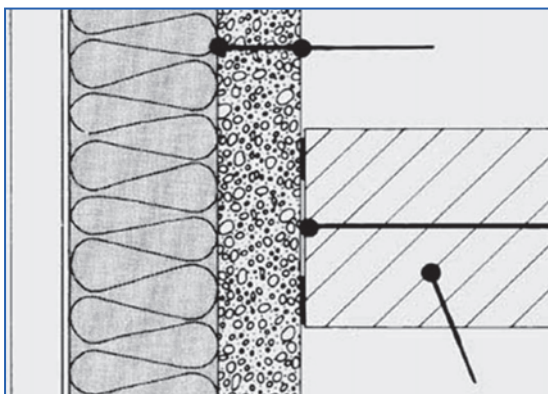
- Air leakage through holes, gaps or cracks.
- Unintended stiff connections between building elements that are designed to be separated, so called structure borne sound bridges.
- Unintended weak connections between building elements that are designed to be rigidly connected may give unexpected flanking transmission.

The following pictures show some examples of common errors.





**Figure 26.14.** Casting waste between separated floor plates for row houses causing sound bridges.



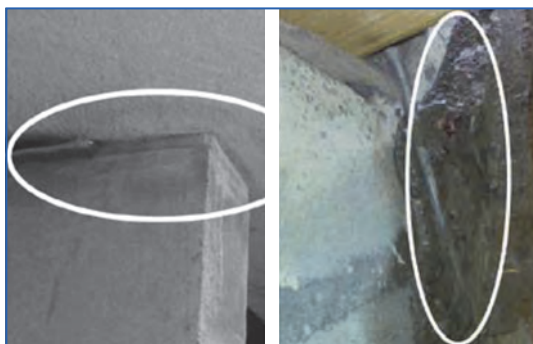
**Figure 26.15.** Leakages due to missing sealing between prefabricated concrete elements. Wrong dimensions of walls and floors can also result in unexpected flanking transmission.



**Figure 26.16.** Holes not sealed.



**Figure 26.17.** Floating floor in contact with the walls leading to flanking transmission.



**Figure 26.18.** Casting waste shortcutting elastically supported staircase.



**Figure 26.19.** Wrong installation of resiliently suspended ceiling causing sound bridges, reducing the effect of the resilient mounting.

### 26.1.3. Existing housing

#### *Typical constructions found in existing stock and their acoustic performances*

#### **Period of building, description of the building and acoustic performances**

An overview of the history of the existing building stock can be found in [9] (in Swedish). The housing stock in Sweden was recently investigated in a national survey called BETSI. Energy performance, technical status and indoor environment were reviewed for the existing housing stock, based on inquiries and inspections. Some of the questions were related to acoustics. Results from that project are publicly available [10].

Historically, wood has been used as building material for residential houses for a long time in Sweden. Also masonry as building material was common in regions where clay was available. However, in the late 19<sup>th</sup> century, multi-storey houses with more than two floors made from wood were not allowed because of fire regulations. Most multi-storey houses built in the 20<sup>th</sup> century are therefore mainly made in heavyweight constructions, mainly masonry or homogeneous or hollow-core concrete. However, many small houses and detached single family houses were constructed from wood during this period.

In the period 1900 – 1930 masonry was common in houses in cities with more than 2 floors, and massive wood in other buildings. Wooden joist floors with various fillings were common for floor constructions, also in higher buildings. However, one type of residential building built in the late 1800 and early 1900 is the so-called “Landshövdingehus”, where the ground floor was in masonry with two floors made of wood on top. The upper floors in these houses were made with rather weak wooden joist constructions with various fillings. The vertical sound insulation in such houses is often poor and could be in the order of  $R'_w$  30-35 dB [11] and impact noise levels can reach over  $L'_{n,w}$  80 dB [11]. The horizontal sound insulation in separating walls could be somewhat better  $R'_w$  40-45.

After 1930 concrete became more common as building material in multi family houses. During the 1950s and 1960s there was a strong economic growth as well as growth in population and urbanisation. Many of the existing buildings had a poor technical standard and were in need of renovation. A lot of the “Landshövdingehus” were demolished. A large

national building programme was initiated and between 1965 and 1975 about one million new apartments were built in Sweden, the so-called million programme houses. On-site cast concrete was typically used for floors and separating walls. Typical floor constructions were a concrete floor thickness of 160 – 190 mm with a floating wooden floor or board on top of a sand bed as elastic layer. Separating wall constructions were typically made by 100-160 mm on-site cast concrete. Also lightweight concrete floors and walls were used, leading to problems with sound insulation in many cases.

Somewhat later, in the 1970s, prefabricated concrete elements became more common both for walls and for floors.

When the Swedish building code was revised in the 1990s, functional requirements were introduced in the regulation and it was allowed to build multi-storey houses using wood, provided that the fire protection was sufficient. Today, multi-storey apartment buildings made from wood is increasing its market share and there are examples of high-rise buildings ( $\geq 8$  floors) using wood as the primary construction material. Wooden houses built during the 1990s could meet the minimum requirements on sound insulation as well as impact noise levels at that time. However, noise complaints were common in lightweight wooden buildings, especially on low frequency impact noise.

In 1999 the minimum requirements for sound insulation were extended to include also the adaptation term for frequencies down to 50 Hz. Buildings erected after that have improved low frequency sound insulation.

According to the national survey of the technical status of the Swedish buildings, BETSI [12], people living in houses built after 1985 are most satisfied with the sound insulation.

### **Methods for improving sound insulation**

A large part of the existing building stock built during the 1960s and 1970s are in great need of refurbishment. At the same time, there is a need to improve the energy performance of the buildings. When renovating these houses, simultaneous improvement of the sound insulation should be done.

Depending on the type of construction there are reliable solutions [10]

- Concrete slab thickness of 16-19 cm

- Glue a new hardwood floor or floor panel and rug over existing intact sand bed
- Scrap the existing flooring / screed / sand, add a concrete topping up to 460 kg/m<sup>2</sup>, new flooring with impact sound improvement  $\Delta L_w \geq 17$  dB
- Scrap the existing floor, leaving any remaining sand, add new floating floor with impact sound improvement  $\Delta L_w \geq 25$  dB.
- Concrete slab thickness of 20 cm or more
  - New flooring with impact sound improvement  $\Delta L_w \geq 17$  dB (parquet or carpet)
- Wooden joist floors
  - Scrap the existing flooring, draw up the floor joists, new elastic interlayers, boards, parquet or carpet.
  - Ceiling of 2 x 13 drywall on free hanging girders/resilient bars
- Prefab concrete and masonry walls
  - Seal joints and cracks
  - Additional lining made of plasterboard fully adhered
- Wooden walls, concrete in interior walls
  - Add detached 2 x 13 drywall on 70 mm wooden studs, 45 mm mineral wool in the air gap
- Exterior walls, heavy wooden walls with brick wall
  - Seal cracks (resistant materials)
- Exterior walls, light, (plank wall or wooden frame)
  - 2 x 13 gypsum interior lining mounted tight
  - 2 x 13 plasterboards interior freestanding on 70 mm - studs
  - 2 x 13 mineral board, external cladding
- Windows
  - Replace with windows of improved sound insulation
  - New outer casement, 8mm glass, seals, new caulking
  - New heavy insulating glass in the inner casement
- Fresh air intake
  - Add damping material or extended it on the inside

## 26.2. References

- [1] Statistics Sweden <http://www.scb.se>
- [2] The Swedish National Board of Housing, Building and Planning (Boverket) <http://www.boverket.se>
- [3] <http://en.wikipedia.org/wiki/Sweden/>
- [4] *Teknisk status i den svenska bebyggelsen* Boverket december 2010 ISBN: 978-91-86559-71-7.
- [5] BFS 2013:14 - BBR 20 Boverkets föreskrifter om ändring i verkets byggregler (2011:6) - föreskrifter och allmänna råd, <http://www.boverket.se/bbr>
- [6] Swedish Standard SS 25267 Byggakustik - Ljudklassning av utrymmen i byggnader - Bostäder.
- [7] SOSFS 2005:6 *Socialstyrelsens allmänna råd om buller inomhus*, The National Board of Health and Welfare (Socialstyrelsen), 2013, <http://www.socialstyrelsen.se/sosfs/2005-6/Sidor/2005-6grundforfattning.aspx>
- [8] *Bullerskydd i bostäder och lokaler*, Boverket november 2008, ISBN 978-91-86045-40-1, ISSN: 1400-1012.
- [9] Björk Cecilia, Kallstenius Per, Reppen Laila, *Så byggdes husen 1880-2000*, Forskningsrådet Formas, ISBN 9154058880.
- [10] *Så mår våra hus - redovisning av regeringsuppdrag beträffande byggnaders tekniska utformning m.m.*, Boverket september 2009, ISBN 978-91-86342-28-9.
- [11] Simmons C., *Ljudisolering i bostadshus byggda 1880-2000 Praktiska erfarenheter och indata för beräkningar*, Rapport 0405, FoU-Väst, 2004, ISSN 1402-7410.
- [12] *Enkätundersökning om boendes upplevda inomhusmiljö och ohälsa - resultat från projektet BETSI*, Boverket oktober 2009, ISBN 978-91-86342-44-9.



# Building acoustics throughout Europe

## Volume 2: Housing and construction types country by country

# 27

## Switzerland

Author:  
**Victor Desarnaulds**

EcoAcoustique SA, Université 24, CH-1004 Lausanne, Switzerland  
e-mail: [desarnaulds@ecoacoustique.ch](mailto:desarnaulds@ecoacoustique.ch)



## CHAPTER

## 27

## Switzerland

## 27.1. Overview of housing stock

## 27.1.1. Quantities of housing stock and total population

Switzerland has an area of 41.000 km<sup>2</sup> and a population of 8 million inhabitants.

“Switzerland has a dense network of cities, where large, medium and small cities are complementary. The plateau is very densely populated with about 450 people per km<sup>2</sup> and the landscape continually shows signs of man’s presence. The weight of the largest metropolitan areas (cf. Table 27.1) tend to increase. In international comparison the importance of these urban areas is stronger than their number of inhabitants suggests [1].



**Figure 27.1.** Examples of attached houses found across Switzerland.



**Table 27.1.** Most populated cities in Switzerland.

City	Population in city	Population in city and agglomeration
Zürich	366.000	1.102.000
Geneva	177.000	493.000
Basel	165.000	486.000
Bern	131.000	349.000
Lausanne	129.000	317.000

### 27.1.2. Proportion of dwellings for different building types

In comparison with other European countries, most of the population in Switzerland is living in flats/apartments situated mainly in attached house. The proportion of detached houses and single unit housing is relatively low (cf. Tables 27.2 & 27.3).

**Table 27.2.** Percentage of population in various housing types in Switzerland (According to Eurostat 2013 [2]).

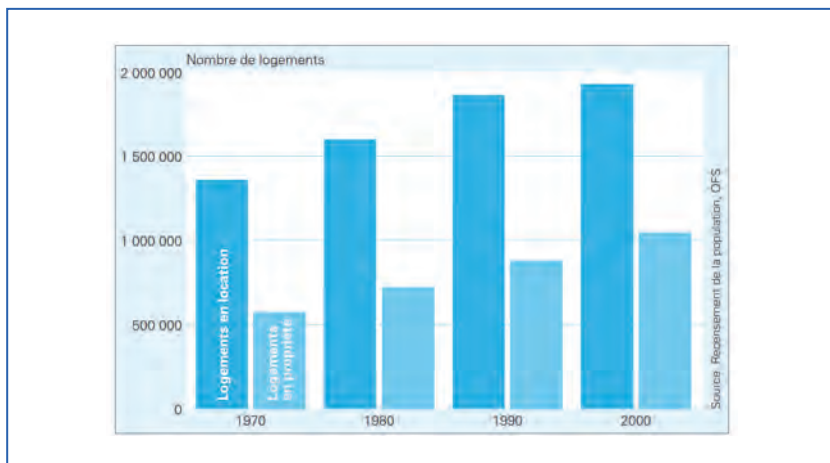
Housing types	% population
Flats/apartments	60.3
Semi-detached row, terraced housing	12.2
Total attached houses	72.5
Single unit housing	24.5
Other	3

**Table 27.3.** Total number of people in various housing types in Switzerland (According to Eurostat 2013).

Housing types	Total number of people
Attached housing	5.854.375
Detached housing	1.978.375

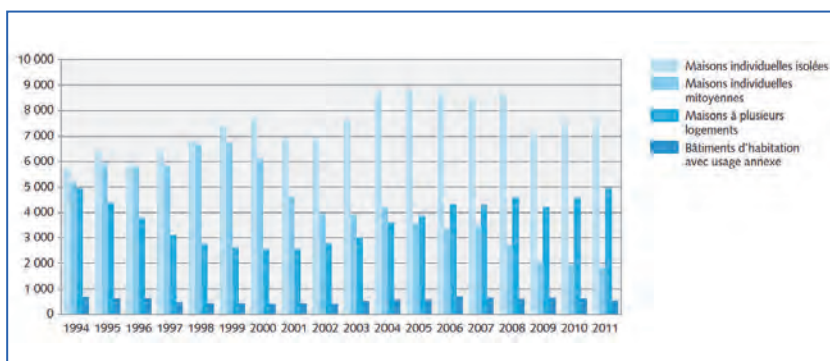
Since 1970, the number of housing (rented or purchased) has increased a lot in Switzerland. In comparison with other European countries, the

proportion of owners is very low in Switzerland. However, this rate has increased in the last decades (Figure 27.2).



**Figure 27.2.** Evolution of the number of dwellings per year for tenants (dark blue) and owners (light blue [3]).

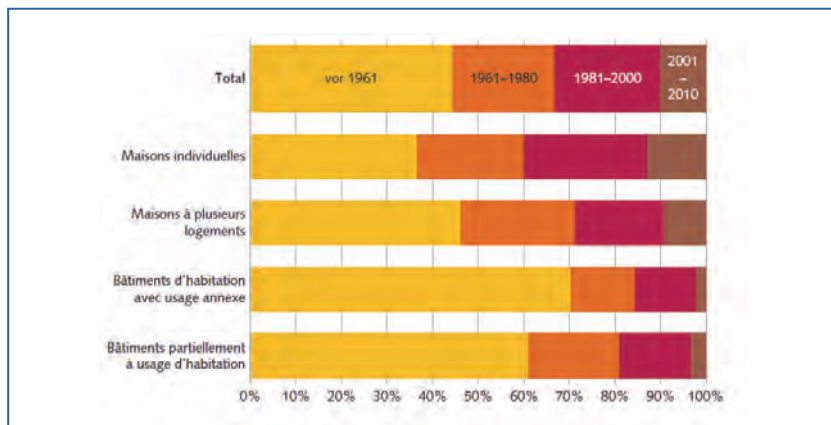
Despite crisis, the new housing output stays relatively high in Switzerland, especially for apartments (with an average of 6 apartments in each collective house, cf. Table 27.3 and Figure 27.3).



**Figure 27.3.** Annual new housing output (from light to dark blue: individual, twin (attached house), collective house, and housing with external use, according to OFS).

**Table 27.4.** Typical annual new housing outputs.

	2007	2008	2009
Individual houses	11.982	11.320	9.149
Apartments in collective houses	30.933	32.871	30.584



**Figure 27.4.** Number of dwellings split up according to types (from top to bottom individual houses, collective houses, housing with other use, house partially dedicated to housing) and construction period; according to OFS [4]).

## 27.2. Requirements

The Swiss standard on building acoustics, SIA 181 [5] (Protection against noise in building) was published by the Swiss Society of Engineers and Architects (SIA) in 1977 and 1988, and was totally reviewed in 2006 [6]. The SIA 181 intends to provide a protection against noise in new (or heavily transformed) buildings. The SIA 181, as all the standards published by the Swiss Society of Engineers and Architects, fits in the legal framework of the civil law. Furthermore, this particular standard is explicitly mentioned in the Federal Noise Abatement Ordinance [7] that confers to it a particular status: Minimal requirements are requested by the administrative law.

### 27.2.1. Requirements levels

The requirements presented in the SIA 181 depend on the class of acoustic quality, the grade of noise source (emission) and the sensitivity to noise (reception).



The SIA 181 includes 3 classes of sensitivity to noise (minimal, increased, and special).

For external sources the grade of noise source is expressed according to the rating level  $L_r$  defined in the Noise Abatement Ordinance. For internal sources, the emission room is characterized by four noise source grades: low, moderate (the most used), high, very high. Each step of the grade of noise source or noise sensitivity class raises the requirements by 5 dB. The increased requirements are 3 dB higher than the minimal requirements.

### 27.2.2. Airborne sound insulation of façades

For medium noise sensitivity (most frequent case) and high noise level ( $L_{rj} \text{ (day)} > 60 \text{ dB(A)}$ ,  $L_{r,n} \text{ (night)} > 52 \text{ dB(A)}$ ) the minimal requirements for airborne insulation of façades ( $D_e$ ) are :

Room for sleeping:  $D_e = D_{nT,w} + C_{tr} - C_v = L_{r,n} - 25 \text{ dB}$  (but  $> 27 \text{ dB}$ )

Other room purposes:  $D_e = D_{nT,w} + C_{tr} - C_v = L_{rj} - 33 \text{ dB}$  (but  $> 27 \text{ dB}$ )

Where  $C_v$  is the receiving room volume correction ( $= 0$  if  $V < 200 \text{ m}^3$ ; up to 5 dB if  $V > 800 \text{ m}^3$ ).

This induces an indoor level (window closed) of approximately  $L_{Aeq} = 33 \text{ dB(A)}$  during day time and 25 dB(A) for night sleeping.

### 27.2.3. Airborne sound insulation between rooms

For moderate noise source grade and medium noise sensitivity (the most frequent case) the SIA 181 gives the following minimal requirement for airborne insulation between dwellings:

$$D_i = D_{nT,w} + C - C_v = 52 \text{ dB}$$

Each increase of the grade of noise source or the noise sensitivity class raises the requirements by 5 dB. The airborne sound requirements range is then from 42 dB (low noise sensibility and noise pollution source) to 67 dB (high noise sensibility and very high noise source grade).

### 27.2.4. Impact noise insulation between rooms

For moderate noise source grade and medium noise sensitivity (the most frequent case) the SIA 181 gives the following minimal requirement for impact noise level:

$$L' = L'_{nT,w} + C_l + C_v = 53 \text{ dB}$$



Each increase of the grade of noise source or the noise sensitivity class induces a decrease of requirement of 5 dB. The impact sound requirements range is from 63 (low noise sensibility and noise source grade) to 38 dB (high noise sensibility and very high noise source grade).

The frequency band for the adaptation term  $C_i$  (according to ISO 717-2) is 100 to 2500 Hz.

To avoid an unjustified bonus for heavy floor (for example concrete with bad floating floor (manufacturing default)), only the positive value of  $C_i$  are considered (if  $C_i < 0$  dB  $C_i = 0$  dB is used)

### 27.2.5. Noise from equipment in building

The service equipment noise (mainly from kitchen and bathrooms) is evaluated through the index  $L_{r,H} + C_v$ , is divided according to:

- The temporal characteristics of the noise: continuous ( $L_{r,H} \approx L_{Aeq}$ ) or short-time (duration  $< 3$  min.,  $L_{r,H} \approx L_{Amax}$ ) noise.
- The source of the sound: related ("user noise" for example impact in tub, dishes in sink or on shelves, closing doors) or unrelated ("operation noise" for example flushing the WC, elevator, HVAC noise) to the action of users.

The following table gives the requirements of the equipment noise (evaluated with  $L_{r,H} + C_v$ ) for standard acoustical quality:

**Table 27.5.** Requirements of the equipment noise.

Type of noise (emission)	Short-time noise		Continuous noise
	Functioning (F)	User (U)	F or U
Noise sensitivity (reception)	Requirements (dB(A))		
Low	38	43	33
Medium	33	38	28
High	28	33	25

To increase the reproducibility of the measurement of "user noise", a new standard hammer was developed [8], [9]

## 27.2.6. Uncertainties, complaints, checklist

### 27.2.6.1. Uncertainties

For planning (calculations), the Swiss standard includes a Project factor  $K_p$  (§4.1.1.2 of SIA 181), without fixing any value for it (according to German Standard DIN 4109, the Project factor is about 2 dB for normal partitions and 5 dB for doors).

For measurements, the Swiss standard requirements must be fulfilled without any tolerance (before 1988, the tolerance was 2 dB in unfavorable direction).

The uncertainty must be mentioned in measurement report (Standard deviation according to § 4.1.4 of SIA 181).

### 27.2.6.2. Checklists

There isn't any Swiss official checklist for verifying good practice or workmanship.

Some specific checklists were however developed by product manufacturers (for example Geberit) or consulting offices.

A checklist for service equipment must be filled up to obtain particular private label (for example Minergie©).

### 27.2.6.3. Complaints

Minimal requirements from SIA 181 standard are mandatory according to the Swiss law for new or retrofitted<sup>1</sup> buildings (NAO [7], art. 32).

According to the Swiss law, local administrations (Canton) are in charge for project checking and complaints management. However, in practice very few measurements are performed by local administration.

Tests after construction are not mandatory and there isn't any specific mechanism for dealing with complaints on new housing.

In case of low sound insulation level, complaints are made by owner to constructor and measurements are realized by consulting office. When the Standard applies (see above) and the requirements are not fulfilled, improvement of the sound insulation is mandatory (financial compensation is not allowed). In case of conflict, a lawsuit in Civil Court is engaged.

---

<sup>1</sup> Example of retrofitting is given in the Standard (SIA181 §0.1.8).



Because of the high number of complaints<sup>2</sup> and specific regulation [10], many cantons ask specific and systematic evaluation for sound insulation with noisy public establishments (pubs, disco, etc.).

### 27.3. New build housing constructions

Constructive solutions and recommendation how to fulfil the Swiss requirements can be found in the guideline Element 30 [11], published by the Swiss industry association terracotta (VSZ).

The Swiss Society of Engineers and Architects (SIA) has published 2 catalogues of typical constructions with related acoustic performances measured in Laboratory [12].

In addition of all these laboratory data (without flanking transmission), in situ measurement results are also included in some private data base of acoustical performances of typical Swiss constructions [13].

#### 27.3.1. Heavy typical constructions

##### 27.3.1.1. Floors

Most of the floors that separate flats include a heavy floating floor (cement screed).

On top of heavy concrete floor of 200 mm (240 mm for increased requirements) a floating floor consisting of 70 mm cement screed and a resilient layer (20 mm mineral wool or EEPS) is used to control impact noise.

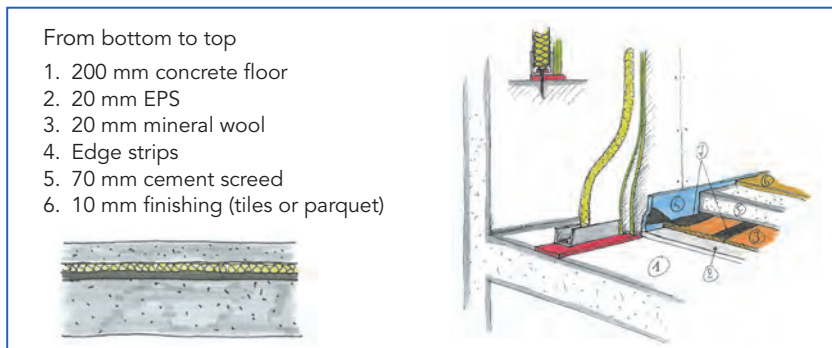
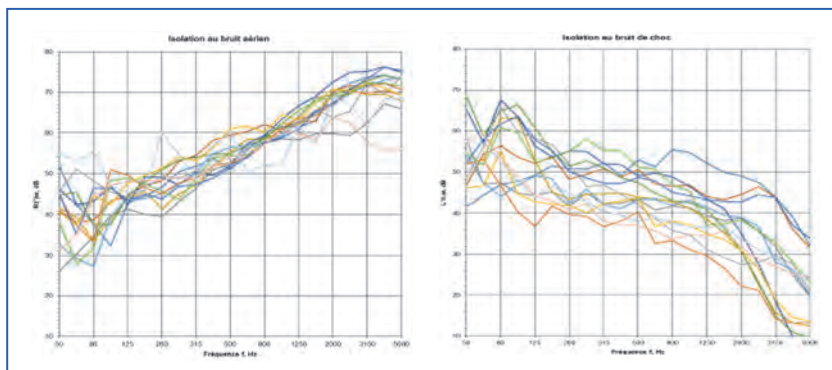


Figure 27.5. Typical floating screed.

Figure 27.6. Typical heavy floors.

<sup>2</sup> For example in Geneva, more than half of the noise complaints are concerning public establishments.

The acoustical in situ performance of 13 typical floors (cf. described above) are presented in the figure and table below. We can notice that the standard deviation is much higher for impact sound (6 dB) than for airborne sound. In fact, impact sound performance is very sensitive to workmanship errors (see hereafter).



**Figure 27.7.** Airborne sound insulation in terms of field sound reduction index (left) and impact sound insulation in terms of normalized impact sound pressure level (right) for 13 typical Swiss floors (7 cm floating cement screed on 22 cm concrete slab)

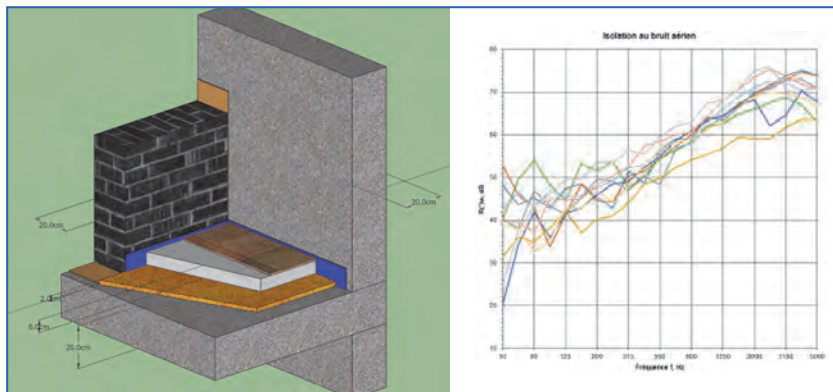
**Table 27.6.** Statistics of the single number values for airborne (weighted sound reduction index  $R'_w$  and spectrum adaptation term, C) and impact sound insulation (weighted normalized impact sound pressure Level,  $L'_{n,w}$ ) for 13 typical Swiss floors.

Index	$R'_w$ in dB	$R'_w + C$ in dB	$L'_{n,w}$ in dB
Min	55	53	35
Max	63	61	56
Average	58.5	57.1	49.5
Standard deviation	2.0	2.0	5.9

### 27.3.1.2. Single leaf concrete wall

This type of walls consists of a single leaf concrete wall and floor of 200 mm (240 mm for increased requirements).





**Figure 27.8.** Sketch and airborne sound insulation (Sound reduction index,  $R'_w$ ) for 10 single leaf concrete walls with thicknesses between 20 to 22 cm.

**Table 27.7.** Statistics of the single number values for airborne sound insulation (weighted sound reduction index  $R'_w$  and spectrum adaptation term, C) for 10 single leaf concrete walls with thicknesses between 20 to 22 cm.

Index	$R'_w$ in dB	$R'_w + C$ in dB
Min	53	52
Max	64	63
Average	58.8	57.4
Standard deviation	2.8	2.9

The airborne sound insulation of 10 typical single leaf walls (20 cm to 22 cm concrete) above) are presented in the figure and table above. We can notice that the standard deviation is higher for walls (3 dB) than for floor (2 dB, see above). This is probably due to higher flanking transmissions in the former case.

### 27.3.1.3. Masonry wall with lining

If the surface mass of the wall is lower than 500 kg/m<sup>2</sup> (masonry wall or concrete wall with thickness < 200 mm) a lining of two gypsum boards is fixed to independent steel frames.

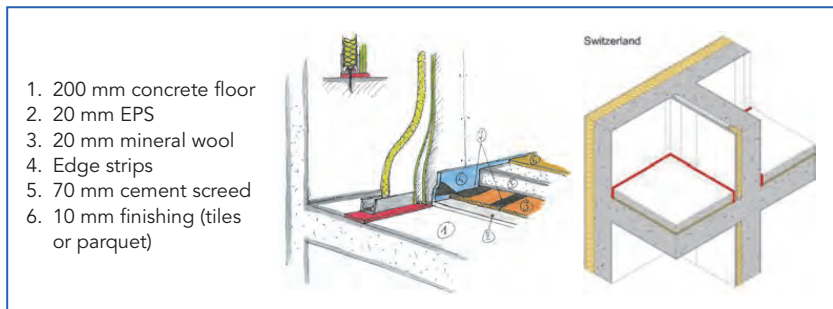


Figure 27.9. Separating wall with lining.

### 27.3.1.4. Cavity walls

The second type of walls consist of two leaf masonry walls (typically 125 to 175 mm heavy brick made of concrete or limestone with plaster or mortar coating) separated by an at least 30 mm thick joint, filled with a 20 mm mineral wool and an air gap of 10 mm. These construction is very typical in Switzerland for twin or row houses.

In case of multi-family house (bunk apartments) a resilient layer should be placed under the two masonry walls to limit the vertical flanking transmissions due to their low mass (< 250 kg/m<sup>2</sup>).

The junction between separating wall and roof should be well designed and executed to limit the horizontal flanking transmissions (no rigid connection and a good airtightness). An example of design is given in the figure below (cf. also in § wormanship errors).

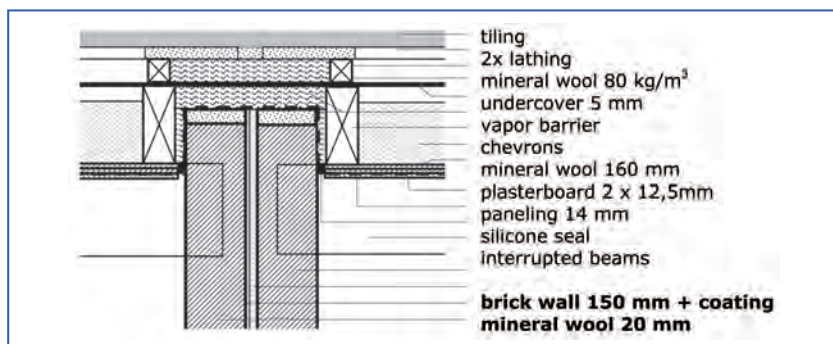


Figure 27.10. Vertical cut of a junction between cavity wall and roof.

## 27.3.2. Lightweight typical constructions

### 27.3.2.1. Introduction

In Switzerland, most of the constructions, especially in multi-family attached housing, are massive (built with concrete or masonry). However, in the last decade, the number of light-weight construction, usually in wooden type, has been significantly increased.

Various examples of lightweight typical Swiss constructions with acoustical performances can be found in COST FP0702 e-book [14] (especially in chapter 4: Acoustic Design of Lightweight timber frame constructions). In the frame of this Action, a research project was carried out by Switzerland on acoustic performances of light-weight construction, especially for equipment noise [15], [16], [17]. Some specific Swiss construction with corresponding acoustical performances can be found as well as in specific books [18].

Lignum, the national wood association, and Bern University of Applied Sciences are coordinating an important research project on building acoustics of wood construction. One of the goal of this project is to build a catalogue of many wood construction with acoustical performance [19].

In this section, various construction types according to their acoustical performances will be presented.

### 27.3.2.2. Standard construction

A typical Swiss lightweight construction designed to fulfill minimal requirements (standard housing) is presented below:

*Construction of the floor (from top to bottom):* 2 cm thick wooden floor, screed + semi-floating 8 cm topping, 2 cm wood fiber insulation, 2 cm Oriented Strand Board (OSB) panel, 20 cm wood slab Lignatur Silence.

The acoustical performances of this standard wooden floor are:

- airborne sound insulation:  $R'_w(C, C_{tr}) = 56 (-1; -5) \pm 1$  dB ( $D_i = 54 \pm 1$  dB)
- impact sound insulation:  $L'_{n,w}(C)_i = 55 (-1) \pm 2$  dB ( $L'_{tot} = 53$  dB)

The study of the attenuation performances of a buffer floor is used to evaluate the propagation conditions in the structure. In these constructions the average difference between the direct transmission (floor  $N$  to  $N-1$ ) and indirect (floor  $N$  to  $N-2$ ) was 4 to 11 dB for airborne noise insulation and about 18 dB for impact noise insulation.

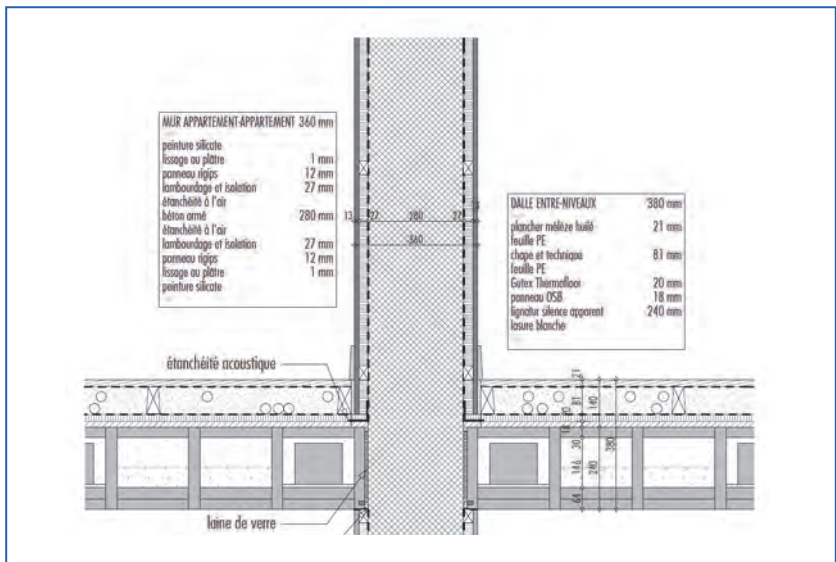


Figure 27.11. Lightweight construction designed to fulfill Swiss minimal requirements.

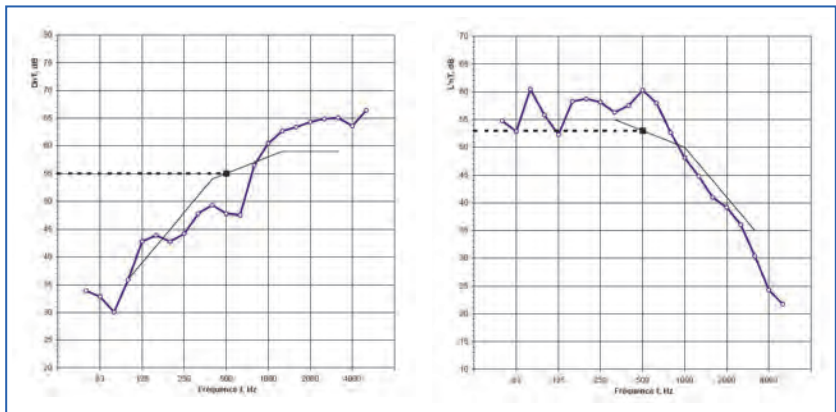


Figure 27.12. Airborne ( $D_{nT,w}(C, C_{tr}) = 55$  (-2, -5) dB) and impact noise insulation ( $L'_{nT,w}(C_i) = 53$  (-1) dB) of a standard floor (fulfills Swiss minimal requirements).

### 27.3.2.3. Quality construction

A typical quality Swiss lightweight construction designed to fulfill increased requirements is presented below:

Construction of the floor (from top to bottom): flooring, 5.5 cm anhydrite floor, 2 cm EPS insulation, 3 cm rock wool insulation, 5 cm EPS insulation, 1.5 cm OSB panel, 20 cm wood slab Lignatur Silence, 3 cm plenum, 2 x 1.25 cm suspended ceiling.

Construction of the wall (between flats): 1.25 + 1.5 cm Fermacell (heavy plasterboard), 2 x 10 cm frame with Isofloc (cellulose insulation)<sup>3</sup>, 1.25 + 1.5 cm Fermacell

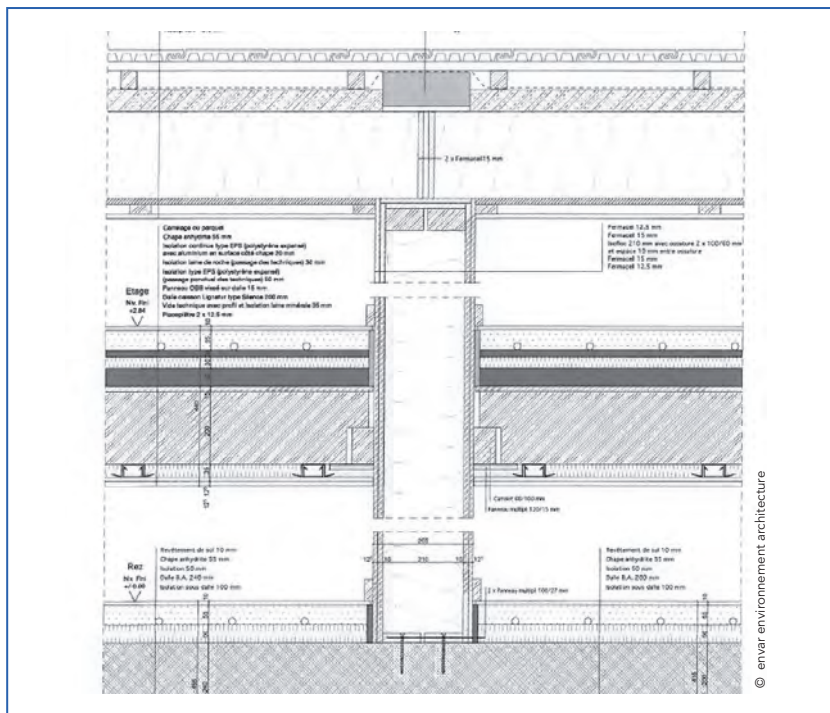
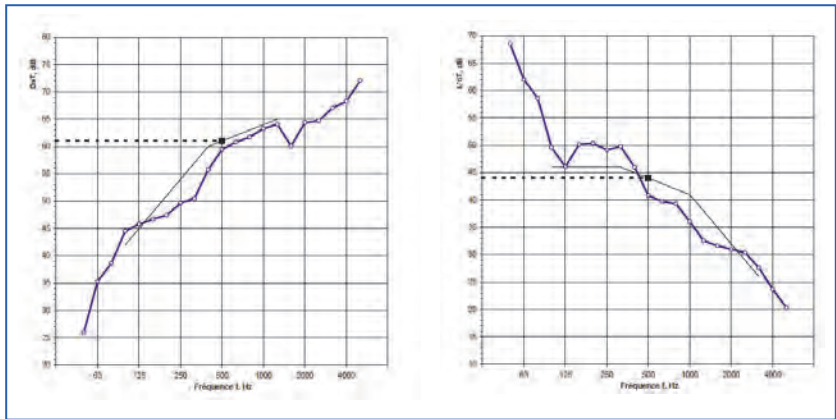


Figure 27.13. Quality lightweight construction designed to fulfill Swiss increased requirements.

The acoustical performances of this high quality wooden floor are:

- airborne sound insulation:  $R'_w(C, C_{tr}) = 58 (-2; -3) \pm 3$  dB ( $D_i = 56 \pm 2$  dB)
- impact sound insulation:  $L'_{n,w}(C_i) = 55 (-1) \pm 2$  dB ( $L'_{tot} = 53$  dB)

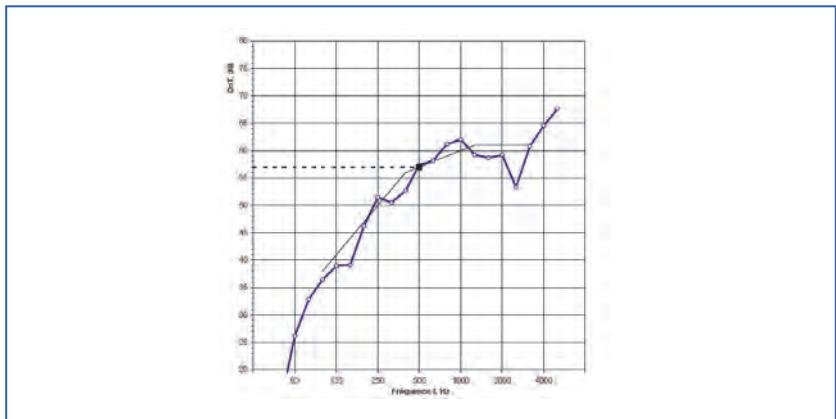
<sup>3</sup> Sustainable materials are often used in Swiss lightweight constructions [21].



**Figure 27.14.** Airborne ( $D_{nT,w}(C, C_{tr}) = 61 (-2, -5)$  dB) and impact sound insulation ( $L'_{nT,w}(C) = 44 (-1)$  dB) of a high quality floor (fulfills Swiss increased requirements).

The acoustical performance of the lightweight wall is:

- airborne sound insulation:  $R'_{w}(C, C_{tr}) = 57(-2; -6)$  ( $D_i = 55$  dB)

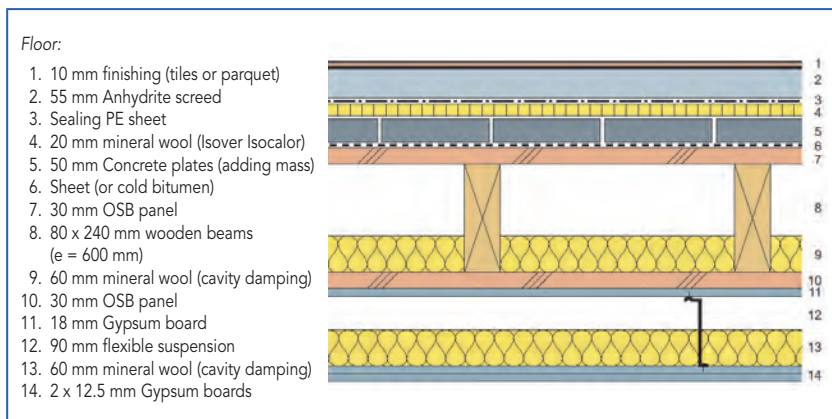


**Figure 27.15.** Airborne  $D_{nT,w}(C, C_{tr}) = 57 (-2, -6)$  dB) of a high quality wall (fulfills Swiss increased requirements).

#### 27.3.2.4. High quality construction

A particular 6-storey Swiss lightweight construction building in Steinhausen, designed to fulfill special (very high quality) requirements is

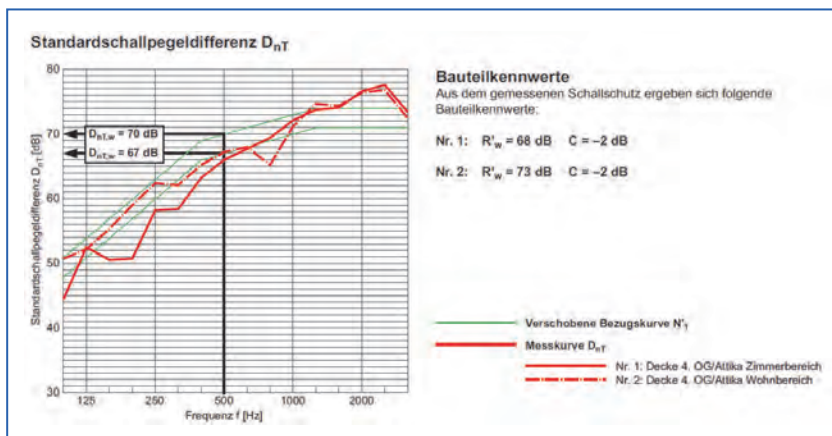
presented below (with special authorization of the constructor Renggli AG, Sursee [20]).



**Figure 27.16.** Very high quality lightweight floor designed to fulfill Swiss increased (or even special) requirements.

The acoustical performances of this very high quality wooden floor are:

- airborne sound insulation:  $R'_w(C) = [70(-2) \pm 3]$  dB
- impact sound insulation:  $L'_{nw}(C_i) = [38(-1) \pm 2]$  dB



**Figure 27.17.** Airborne noise insulation of a high-quality floor (fulfill Swiss special requirements).

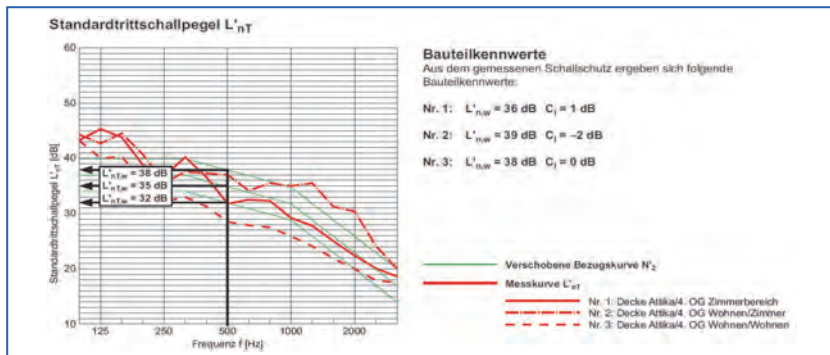


Figure 27.18. Impact sound insulation of a high quality floor (fulfill Swiss special requirements).

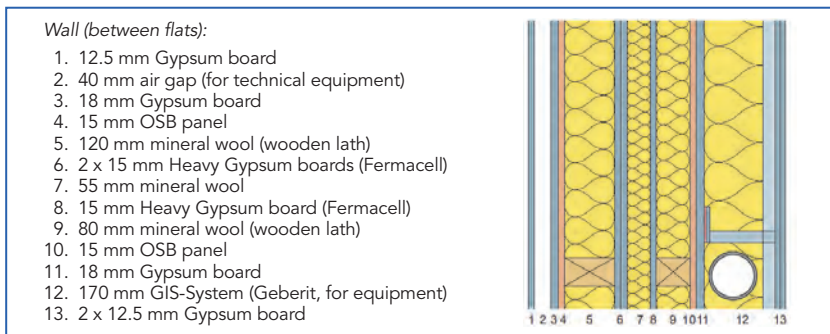


Figure 27.19. High quality lightweight wall designed to fulfill Swiss special requirements.

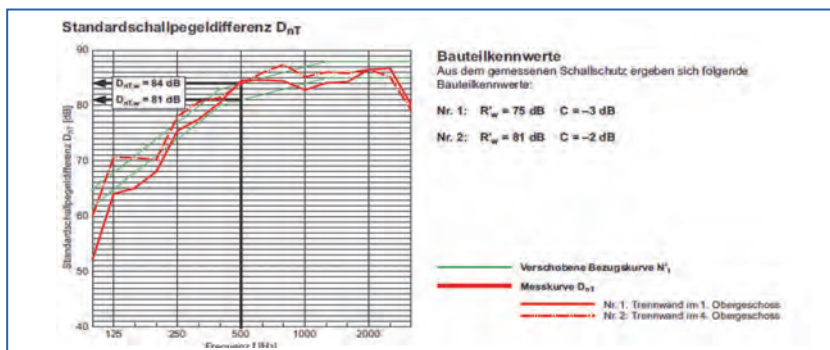


Figure 27.20. Airborne noise insulation of a high-quality wall (fulfill Swiss special requirements).

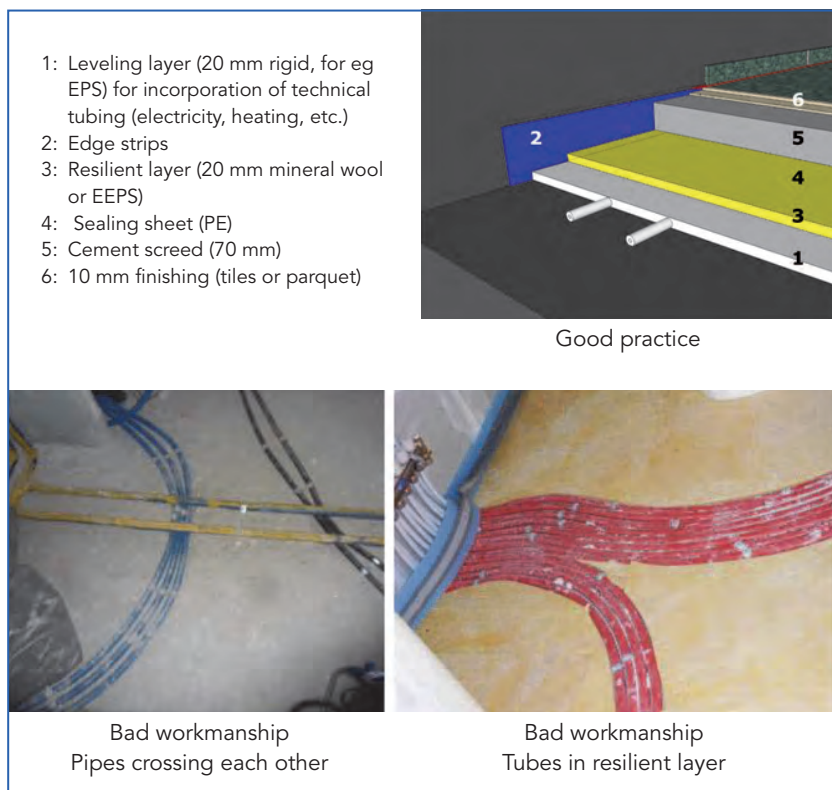


### 27.3.3. Good practice and workmanship errors

In this chapter, good practice and typical workmanship errors are presented.

#### 27.3.3.1. Floor Floating screed (edge strip)

To obtain a good sound insulation (especially for impact noise), the screed should have no rigid contact to the structure (walls and floor). A special attention should therefore be taken to the continuity of the resilient layer and sealing sheet and the edge strips.

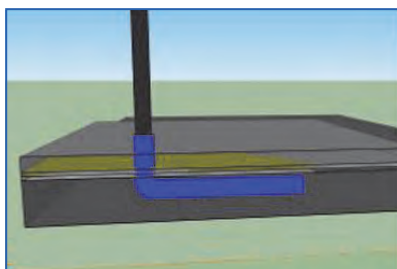


**Figure 27.21.** Good practice and bad workmanship for heavy floating floors (screed).

### 27.3.3.2. Pipes through floating screed

To avoid contact between screed and floor, all the elements (tubes and pipes) crossing the screed should be covered by a soft sleeve (for eg. edge stripe).

To avoid flushing noise underneath, at least the first meter of the pipes penetrating in the concrete floor should be covered by an resilient layer (5 mm soft layer, for eg. edge strips).



Good practice



Bad workmanship  
Electric tubes in floating floor  
without insulating sleeve



Good workmanship



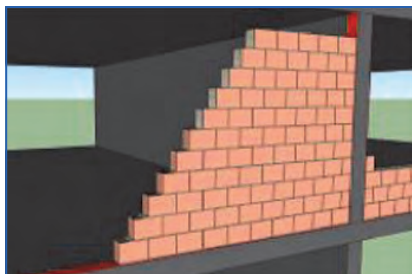
Bad workmanship  
Water pipes in concrete floor  
without insulating sleeve

**Figure 27.22.** Good practice and bad workmanship for pipes through floating screed.



### 27.3.3.3. Wall (or façade) / floor (wall) junction

To avoid flanking transmissions, all the low surface mass walls (with a surface mass lower than  $250 \text{ kg/m}^2$ ; that could be internal walls, but also façades) should be put in a resilient layer. If the wall is perpendicular to a separating wall (between two flats), a vertical resilient layer should also be used between the two walls).



Good practice



Bad workmanship  
Resilient layer on floor covered  
by plaster



Good workmanship



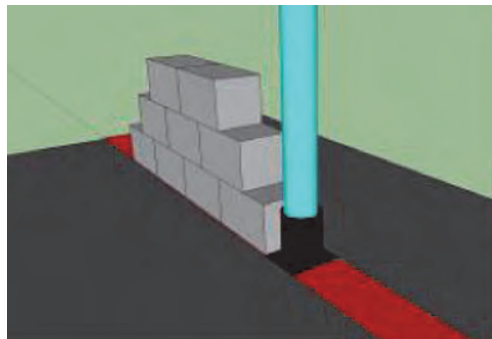
Bad workmanship  
Resilient layer on wall  
covered by mortar

**Figure 27.23.** Good practice and bad workmanship for wall/floor and wall junctions.



#### 27.3.3.4. Pipes through wall

If pipes or tubes are incorporated in low mass walls (which should be avoided if possible), the tube should be enwrapped by a soft layer and the resilient layer should be replaced by a soft sheath.



Good practice



Good workmanship



Bad workmanship

**Figure 27.24.** Good practice and bad workmanship for pipes through walls.



### 27.3.3.5. Wall/roof junction

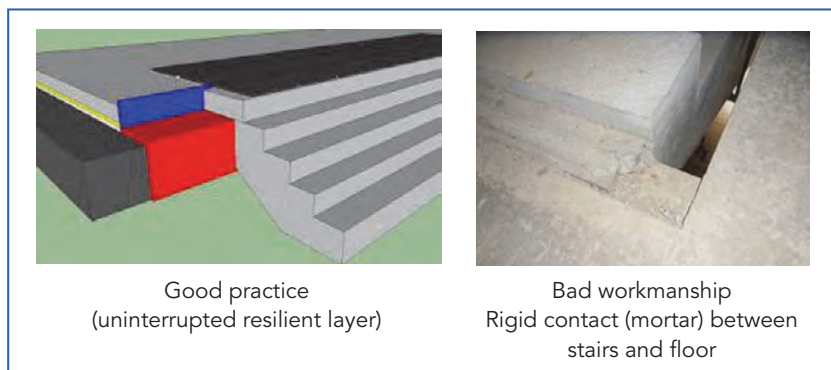
The junction between separating wall and roof should be designed to avoid flanking transmissions through the roof (no rigid connection and a good airtightness).



**Figure 27.25.** Good practice and bad workmanship for wall/roof junctions.

### 27.3.3.6. Stairs/floor junction

To obtain a good impact sound insulation, resilient layers and studs should be used for (prefabricated) stairs to avoid rigid contact to the structure (walls and floor).

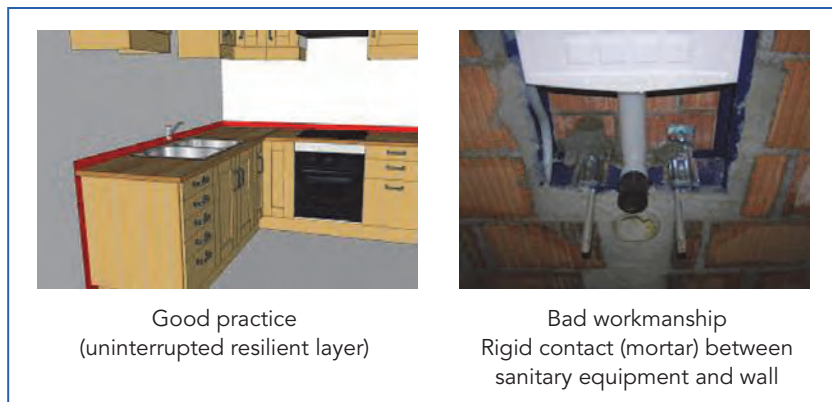


**Figure 27.26.** Good practice and bad workmanship for stairs/floor junction.



### 27.3.3.7. Service equipment fixation

To avoid service equipment noise transmission, a soft layer (mineral wool) fixations should be used between the installation and the structure (walls and floor).

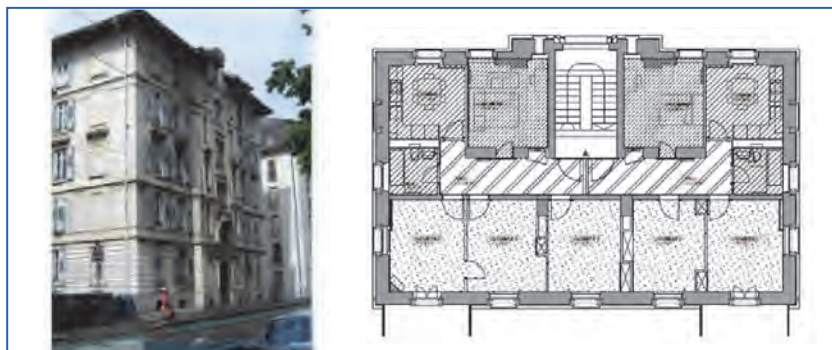


**Figure 27.27.** Good practice and bad workmanship for service equipment fixation.

## 27.4. Existing housing

This section explains the typical housing constructions found in Switzerland with description of their related acoustical performances. Examples of retrofitting are also given.

### 27.4.1. Before 1930

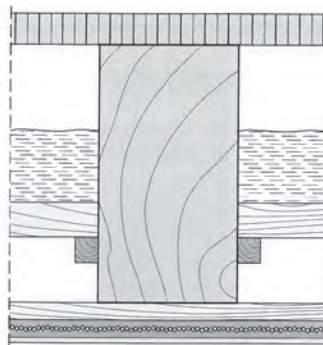


**Figure 27.28.** Typical construction from the 1900's.

### 27.4.1.1. Brief description

The typical construction of the separating elements are

- Party wall: Light or heavy masonry wall
- Inner wall: Hollow Brick wall with plaster on both faces, 10 cm thick
- Facade wall: heavy masonry wall
- Floor: lightweight wooden joist
- 2.5 cm wooden floor on studs
- 2 cm wooden panel
- 1 2 x 20 cm joist (55 cm space)
- Within 10 cm load (sand)
- 3 cm plaster on wood
- About 175 kg/m<sup>2</sup>



### 27.4.1.2. Acoustical performance

The measurement results are given below

Measured in laboratory

$$R_w(C, C_{tr}) = 49 (-2, -7) \text{ dB}$$

$$L'_{n,w}(C_p) = 62 (0) \text{ dB}$$

Measured in situ

$$R'_w(C, C_{tr}) = 47 (-2, -7) \text{ dB}$$

$$L'_{n,w}(C_p) = 63 (1) \text{ dB}$$

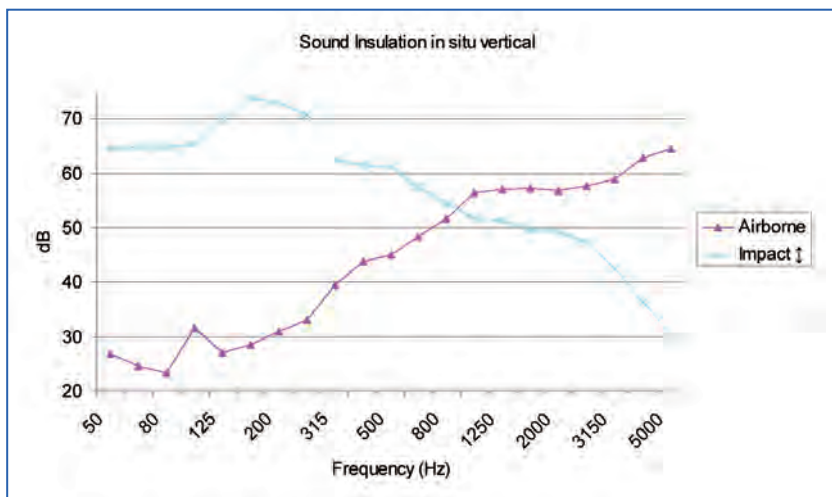
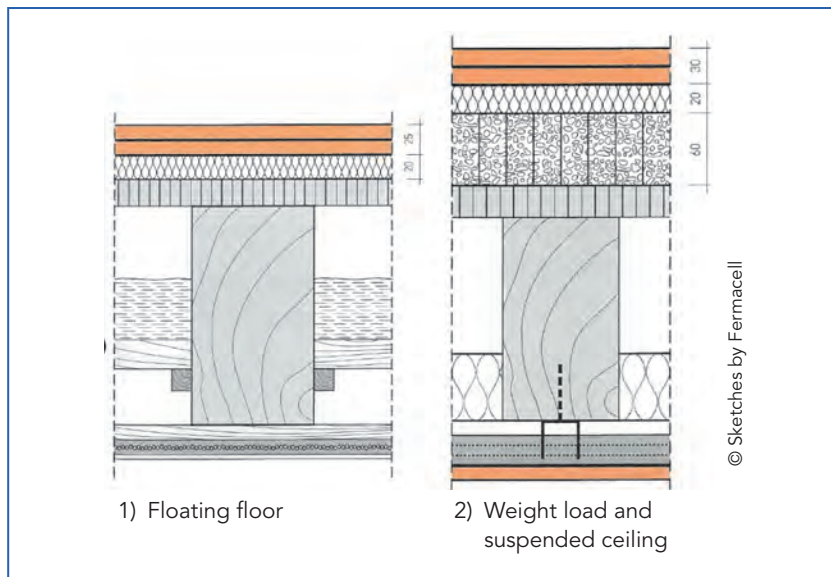


Figure 27.29. Airborne (pink triangles) and impact sound (blue crosses) insulation of 1900's timber based floors.



### 27.4.1.3. Floor retrofitting

The timber floor was retrofitted with a floating floor (solution 1, left on the following figure) or a floating floor on a weight load on top of the timber floor and a suspended ceiling (solution 2, right on the following figure).



**Figure 27.30.** 2 retrofitting solutions of 1900's timber based floors...

Retrofitted timber floor description (floating floor in *italic*, weight load + ceiling in **bold**):

- 2 x 1.25 cm heavy gypsum boards
- 2 cm mineral wool
- **6 cm honeycomb with dry sand**
- 2.5 cm wooden floor on studs
- 2 cm wooden panel
- 12 x 20 cm joist (55 cm space)
- Within 10 cm load (construction waste)
- **3 cm mineral wool**
- **2 x 1.25 cm gypsum board (resilient suspension)**



Acoustical performances measured in laboratory:

Before retrofitting:

+ floating floor (*italic*)

$$R_w(C, C_{tr}) = 49 (-2, -7) \text{ dB}$$

$$R_w(C, C_{tr}) = 68 (-4, -11) \text{ dB}$$

$$L_{n,w}(C_i) = 62 (0) \text{ dB}$$

$$L_{n,w}(C_i) = 48 (1) \text{ dB}$$

+ weight load, floating floor, suspended ceiling (*italic + bold*)

$$R'_w(C, C_{tr}) = 78 (-7, -15) \text{ dB}$$

$$L'_{n,w}(C_i) = 39 (1) \text{ dB}$$

27.4.2. Period 1920- 1950

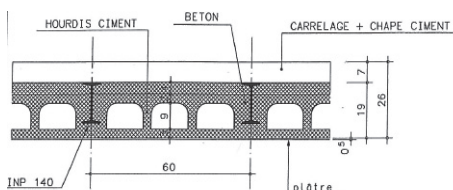


Figure 27.31. Typical construction in 1920-1950 period.

27.4.2.1. Brief description

The typical construction of the separating elements is

- Party wall: Hollow cement wall with plaster on both faces, 20 cm thick
- Inner wall: Hollow Brick wall with plaster on both faces, 10 cm thick
- Facade wall: Cavity wall, 26 cm thick
- Floor: Cement screed, concrete hollow block floor 26 cm  
1 cm tiles floor covering  
6 cm cement screed  
19 cm concrete hollow blocks  
3 cm plaster



### 27.4.2.2. Acoustical performance

The acoustical performance was measured in situ with the following results

$$R'_w(C, C_{tr}) = 49 (-1, -5) \text{ dB}$$

$$L'_{n,w}(C) = 64 (-2) \text{ dB}$$

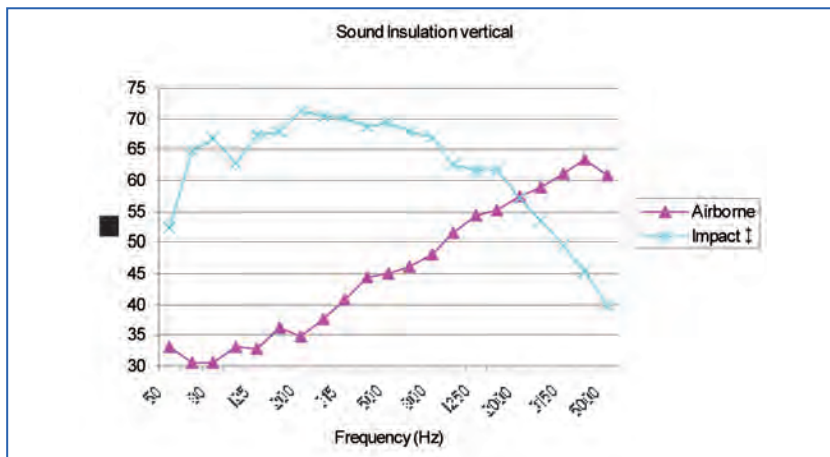


Figure 27.32. Airborne (pink triangles) and impact sound (blue crosses) insulation of hollow blocks floors.

### 27.4.2.3. Floor retrofitting

The acoustical performance of the hollow brick floor was increased with a suspended ceiling. The following figure shows a vertical cross section of the retrofitted floor.

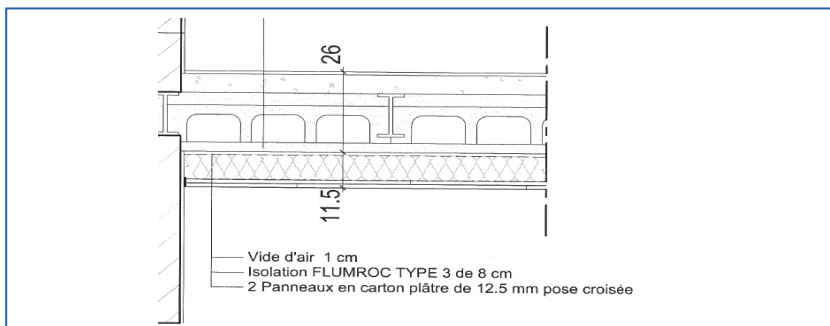


Figure 27.33. Retrofitting of hollow blocks based floors.

The construction of the retrofitted floor (*retrofitting in italic*) is given as:

- 1 cm tiles floor covering
- 6 cm cement screed
- 19 cm concrete hollow blocks
- 3 cm plaster
- 1 cm cavity
- 8 cm mineral wool
- 2 x 1.25 cm gypsum board

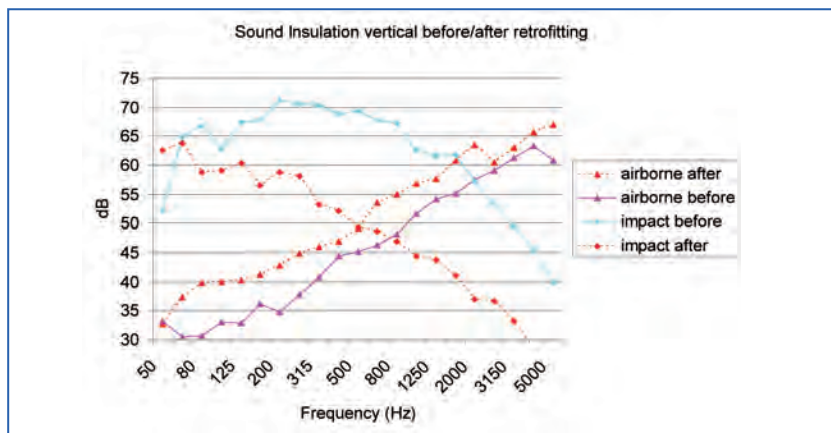
The measurements of the acoustical performance measured *in situ* are

Before retrofitting: After retrofitting (*suspended ceiling*)

$$R'_w(C, C_{tr}) = 49 (-1, -5) \text{ dB} \quad R'_w(C, C_{tr}) = 55 (-1, -5) \text{ dB}$$

$$L'_{n,w}(C_f) = 64 (-2) \text{ dB} \quad L'_{n,w}(C_f) = 51 (0) \text{ dB}$$

The next figure shows a comparison of the acoustical performance of the floor before and after the retrofitting.



**Figure 27.34.** Airborne (red and pink triangles) and impact sound (blue and red crosses) insulation before/after retrofitting the hollow blocks floor.

#### 27.4.2.4. Wall retrofitting

The construction of the separating wall is given as:

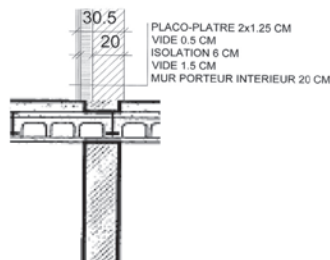
- Hollow Brick wall:
- 1 cm plaster
- 18 cm hollow cement brick
- 1 cm plaster



The acoustical performance was enhanced with an acoustical lining:

*Retrofitted brick wall description (lining in italic):*

- Hollow brick wall:
- 1 cm plaster
- 18 cm hollow cement brick
- 1 cm plaster
- 6 cm mineral wool
- 1.5 cm space
- 2 x 1.25 cm gypsum board



The next figure illustrates the measurement results of the acoustical performance measured in situ:

Before retrofitting:

+ after retrofitting (lining)

$$R'_w (C, C_{tr}) = 50 (-1, -5) \text{ dB}$$

$$R'_w (C, C_{tr}) = 58 (-1, -10) \text{ dB}$$

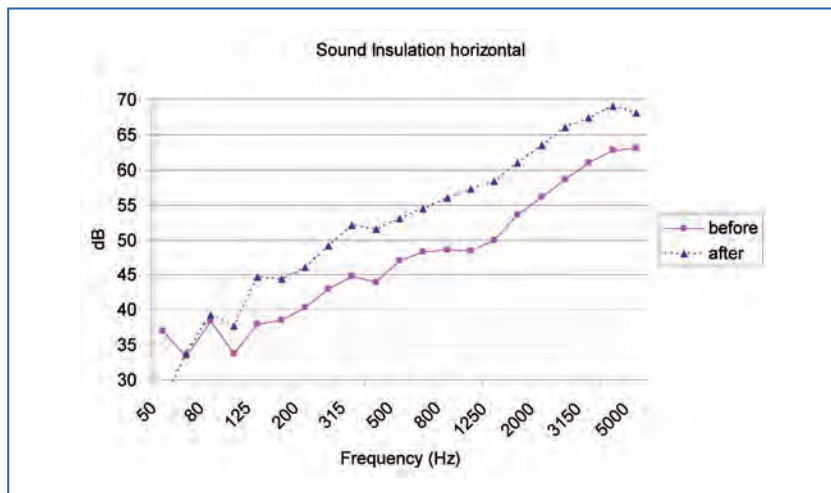


Figure 27.35. Airborne sound insulation before/after retrofitting brick wall.

#### 27.4.2.5. Façade/windows retrofitting (historical building)

The construction of the window is shown in the following figure in a horizontal section.

Original window (single 3 mm glazing):

Acoustical performance:  $R_{w, window} = 23 \text{ dB}$

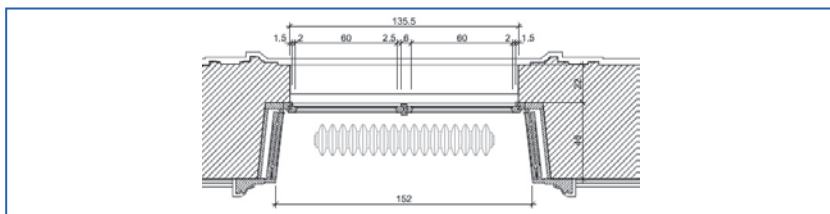


Figure 27.36. Sketch of original historical window (3 mm single glazing).

Retrofitted window 1 (new double glazing, in red in the following figure):

The acoustical performance was increased by replacing the single glazing by a double glazing even thin (3 mm glazing + 6 mm Krypton + 3 mm glazing)

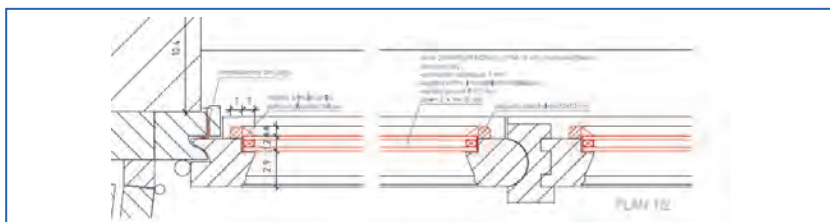


Figure 27.37. Sketch of retrofitted window (new double glazing).

Retrofitted window 2 (double window, in red in the following figure):

The acoustical performance was much more dB increased ( $R_{w, window} = 41 \text{ dB}$ ) by adding a new single glazing (3 mm glazing + 1 mm PVB + 5 mm glazing).

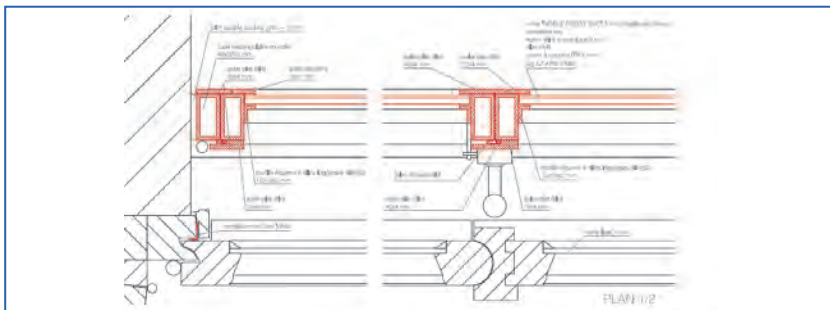


Figure 27.38. Sketch of retrofitted window (double window).

## 27.4. References

- [1] Wikipedia "Switzerland".
- [2] Eurostat, Housing Conditions Statistics. European Commission, 2013.
- [3] OFS, Logement 2000, Bulletin du logement, Volume 75.
- [4] Valeurs- Construire, Habiter : le paysage urbanisé de la Suisse. Magazine d'information de l'Office fédéral de la Statistique, N2/2011.
- [5] SIA181:2006 Standard: Protection against noise in Buildings. Swiss Society of Engineers and Architects (SIA).
- [6] Victor Desarnaulds, Full revision of the Swiss standard on building acoustics SIA181; Proceedings Internoise 2004, Prague.
- [7] Noise Abatement Ordinance of 15 December 1986 (NAO).
- [8] M. Walk, F. Emrich, F. Leuthard, Entwicklung von Simulationenmethoden für haustechnische Benutzer Geräusche, Proc. DAGA 2003, Aachen.
- [9] Delphine Bard, Victor Desarnaulds In situ and laboratory measurement of service equipment decoupling in lightweight constructions, Proc. Internoise 2013, Innsbruck.
- [10] Directive du 10 mars 1999 : Détermination et évaluation des nuisances sonores liées à l'exploitation des établissements publics.
- [11] Element 30, Protection contre le bruit dans le bâtiment, Faktor Verlag, ([www.element30.ch](http://www.element30.ch)).
- [12] Bauteildokumentation – Schallschutz im Hochbau, Dokumentation D0139 and D0189, Swiss Society of Engineers and Architects.
- [13] T. Juguin & V. Desarnaulds, Etat de la pratique constructive Suisse Frühlingstagung des Schweizerische Gesellschaft für Akustik (SGA) in Brugg May 5th 2011, <http://www.sga-ssa.ch/f/events/event.php?eid=191>.
- [14] Action FP0702 : Net-Acoustics for Timber based lightweight buildings and elements. Free E-book <http://extranet.cstb.fr/sites/cost/ebook/Forms/AllItems.aspx>.
- [15] Victor Desarnaulds et al "Swiss pendulous hammer for decoupling measurement of service equipment in wooden multi-storey building", Euronoise 2012, Prague.
- [16] D Bard, V. Desarnaulds et al, "Swiss pendulous hammer for decoupling measurement of Swiss methodology for decoupling measurement of service equipment in buildings" Internoise 2012 (New-York, August 19-22).
- [17] D Bard, V. Desarnaulds et al, "In situ and laboratory measurement of service equipment decoupling in lightweight constructions" Internoise 2013 (Innsbruck, September 15-18, 2013).

- [18] Josef Kolb, Bois – Systèmes constructifs, Presses Polytechniques et Universitaires romandes (PPUR), 2010.
- [19] Schallschutz im Holzbau, Kooperationsprojekt Lignum Holzwirtschaft Schweiz - Berner Fachhochschule Architektur, Holz und Bau [http://www.lignum.ch/uploads/media/Kooperationsprojekt\\_BFH-Lignum\\_Schallschutz\\_im\\_Holzbau.pdf](http://www.lignum.ch/uploads/media/Kooperationsprojekt_BFH-Lignum_Schallschutz_im_Holzbau.pdf).
- [20] <http://www.holzhausen.ch>.
- [21] Desarnaulds V. et al. , “Sustainability of acoustic material and acoustic characterization of sustainable materials”, ICSV12, Lisbon, 2005Sdfj.
- [22] V. Desarnaulds, B. Rasmussen, “Harmonisation des réglementations européennes dans le domaine de l’isolation acoustique dans le bâtiment (COST TU0901)”, CFA10, Lyon apr. 2010.



# Building acoustics throughout Europe

## Volume 2: Housing and construction types country by country

# 28

## Republic of Turkey

Author:  
**Selma Kurra**

Prof.Dr. (retired from Istanbul Technical University), Acoustic Consultant of dB-KES Engineering Ltd, Istanbul, Republic of Turkey,  
e-mail: selma.kurra@db-kes.com.tr





## CHAPTER

## 28

## Turkey

## 28.1. Overview of housing stock

### *The quantities of housing stock and total population*

The construction sector in Turkey grew by 11.5% in 2011 and 0.6% in 2012. Real estate leasing and business activities have become the fastest growing subsector with 9.3 % in 2011 and 6,6% in 2012. The housing stock on sale was estimated in 800.000 units in 2013. However, there is no information available about the number of residential buildings in Turkey.

The total population of the Turkish Republic is 75.627.384 (2012). (Ref: <http://www.tuik.gov.tr/UstMenu.do?metod=temelist>)

### *Most populated cities*

There are 81 cities and 800 towns in Turkey. The most populated cities are displayed in Table 28.1.

**Table 28.1.** Population in the Principal Cities (31/12/2012).

Ref: <http://en.wikipedia.org/wiki/Turkey>

	Name	Population
1	İstanbul	13.522.528
2	Ankara	4.417.522
3	İzmir	2.803.418
4	Bursa	1.734.705
5	Adana	1.628.725
6	Gaziantep	1.421.359
7	Konya	1.107.886
8	Antalya	994.306
9	Diyarbakır	892.713
10	Mersin	876.958
11	Kayseri	865.393

Istanbul, which is the biggest city, has a population density of 2.400 per km<sup>2</sup>. The number of houses in Istanbul is 2.291.228 (of which 308.000 are not occupied.)

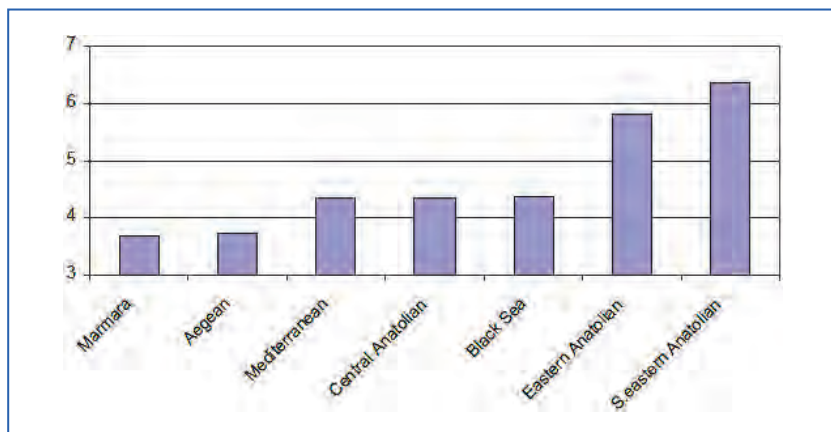
Number of households: total number of households in Turkey is 19.481.678 and the average size of household is 3,8. (Ref: <http://www.tuik.gov.tr/PreHaberBultenleri.do?id=15843>)

The list given in Table 28.2 shows the cities covering both maximum and minimum household numbers. (Ref: Population And Housing Census, 2011 published by Turkish Statistics Institute, Jan 2013)

Figure 28.1 shows the average size of households according to region.

**Table 28.2.** Cities and numbers of household (dwellings).

Cities with max household	Household number	Cities with min household	Household number
İstanbul	3.699.930	Bayburt	17.712
Ankara	1.435.174	Tunceli	21.825
İzmir	1.213.331	Ardahan	23.546
Bursa	743.394	Kilis	27.716
Antalya	600.514	Hakkari	34.345



**Figure 28.1.** Average size of the urban households (number of family members) according to the geographical regions of Turkey, 2000 (Ref: SIS 2003, General Census of 2000 (no.2759) pp.96-97) (Received from: S.C.Oğuz, “The Use and Efficiency of Housing Stock in Turkey”, Thesis report, METU Ankara, 2003).

## Types of houses

The housing sector has seen a significant rising after 2004. All over the country, urban transformation projects are being realized, especially after the earthquake risks were evidenced, thus the older parts of the cities are being demolished and completely new built-up areas are created. However, this action brings various social and economical problems causing ongoing disputes and public reactions.

23,1% of the total households in Turkey are living in buildings with 6 or more floors. The others are given in Table 28.3.

**Table 28.3.** *Distribution of households according to the building type.*  
Ref: Turkish Statistics Institute, Jan 2013.

Percentage of household living	Building floors
20 %	1 floor
25,5 %	4-5 floors
23,1 %	6 floors and above

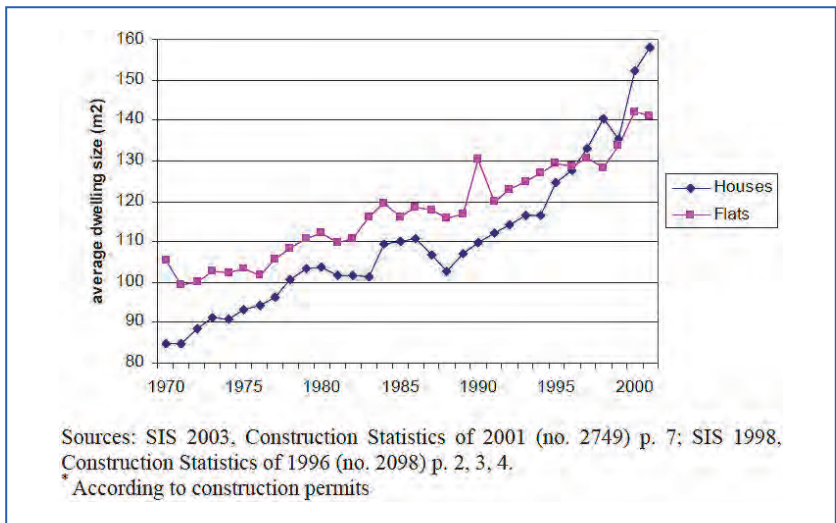
The maximum number of households living in single storey buildings are located in Eastern Anatolia and the minimum number is obtained for Istanbul and Ankara. The max number of households living in buildings with 6 and more floors, are in Istanbul (41,7%), Ankara (39,5%) and Kayseri (38,8%).

Regarding the age of the existing houses, 21,8% of the households are living in the buildings of 10 years old and less than 10 years. (Oct. 2011).

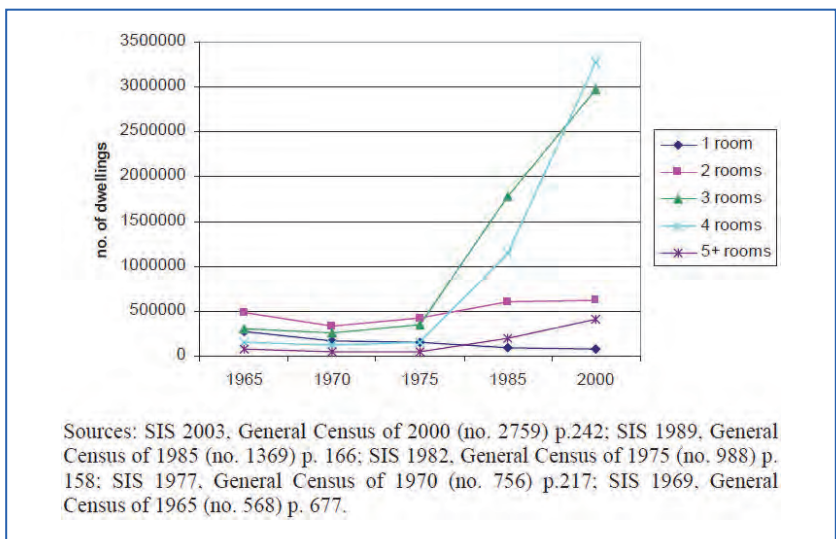
Average dwelling size in Turkey (1985-2000) according to construction permits changed from 80 m<sup>2</sup> in 1970 to 160 m<sup>2</sup> in 2000. (Ref: SIS 2003, Construction Statistics of 2001 (no. 2749) p.7). Figure 28.2 shows that the average dwelling size is increasing with years.

The average floor area is increasing yearly in line with the higher demand coming from high income groups. The average space per person for all tenures is 25,76 m<sup>2</sup> (Ref: SIS Household Income and Expenditure Survey in Turkey (Raw Data), 1994). Figure 28.3 displays the variation in number of dwellings including different number of rooms with respect to the years.

Data about ownership of Houses is given in Table 28.4.



**Figure 28.2.** Average dwelling size in Turkey (1985-2000) (Ref: S.C.Oğuz, "The Use and Efficiency of Housing Stock in Turkey", Thesis report, METU Ankara, 2003).



**Figure 28.3.** Change in number of dwellings of different size in Turkey in province centers (1965-2000) (Received from: S.C.Oğuz, "The Use and Efficiency of Housing Stock in Turkey", Thesis report, METU Ankara, 2003).

**Table 28.4.** Percentages of the households according to the ownership  
(Ref: Turkish Statistics Institute, Jan 2013).

Situation	Percentage
Owner	67,3 %
Tenant	23,8 %
Employees in public houses	1,5 %
Others	7,4 %

### *Proportion of apartments, terraced (row) and detached*

Most of the residential buildings are called “apartment-type” consisting of two or more households on one floor. In the 1980’s, those were produced by the building cooperatives founded by the owners themselves. Then the construction companies and big housing corporations became involved in the building sector.

Nowadays it is common to see various multi-storey residential blocks with 20 or even 50 floors in the cities, since the high-rise buildings are considered as symbols of modern urban life in Turkey, especially after the 1980s. Some of those have multi-functional design by mixing dwellings with offices and shopping centres located at lower floors. The high-rise luxurious residence buildings of various types are built in and around the major cities without paying much attention to environmental issues, land-use and transportation plans.

Row houses were built in 1960-1990 as cooperative summer houses by the sea-side; recently single houses (villas) are common in touristy regions and rural areas. The detached houses in cities are not preferred much because of land prices and safety concerns. There is no published document about percentages regarding house types.

### *Typical number of new homes built per year*

The entire data are not available at the moment. According to recent information given by the Housing Development Administration (TOKI), which is a governmental institution, the number of houses constructed by TOKI 1984-2013, is 608,827 (of which 85% is condominium). The number of dwellings already sold is 491,250. (Ref: Report issued on 31.10.2013 [www.toki.gov.tr/](http://www.toki.gov.tr/)). In Table 28.5 is shown the number of houses sold in major cities in 2011 and 2012. House sales reached their peak in the last quarter of 2012 with 125,815 houses. The tendency to purchase houses revealed an increase of 5.9% compared to the same quarter of the previous period.

**Table 28.5.** Houses sold per major cities in 2013 (ref: Turkish Statistics Institute).

Periods	Throughout Turkey	Istambul	Three Major Cities	Other Cities
2011 Q1	91.071	18.768	39.501	51.570
2011 Q2	107.308	22.343	46.432	60.876
2011 Q3	101.754	18.494	40.445	61.309
2011 Q4	118.867	24.249	49.547	69.320
2012 Q1	96.092	20.778	40.768	55.324
2012 Q2	106.035	23.040	45.201	60.834
2012 Q3	103.543	19.422	40.043	63.500
2012 Q4	125.815	24.244	50.887	74.928

### *Increase in construction licenses and occupancy Permits*

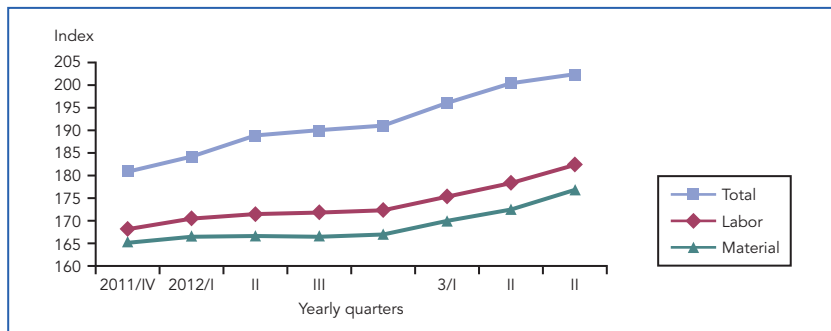
A significant increase was observed in the number of construction licenses and occupancy permits obtained in the last quarter of 2012 (Table 28.6). The number of construction licenses and occupancy permits obtained in the last quarter were respectively 225,873 and 177,980. (Ref: "The real estate sector in Turkey and the world fourth quarter, 2012" Gyoder, The Association Of Real Estate Investment Companies. [http://www.gyoder.org.tr/PDFs/Publishings/2012\\_IV\\_QuarterEN.pdf](http://www.gyoder.org.tr/PDFs/Publishings/2012_IV_QuarterEN.pdf)), The construction period depends on the size of the building and building complex, on average it is 2 years.

**Table 28.6.** Construction Licenses and Occupancy Permits at the quarters of 2011 and 2012. Ref: Turkish Statistical Institute.

Periods	Number of building permits	Number of building usage certificates
2011 Q1	110.619	105.973
2011 Q2	164.694	144.694
2011 Q3	154.923	139.341
2011 Q4	220.049	165.155
2012 Q1	115.637	108.798
2012 Q2	231.966	129.562
2012 Q3	168.116	123.645
2012 Q4	225.873	177.980



**Increase in building costs:** The costs of building construction has increased by 2,3% relative to the previous quarter in 2013. The increase in costs of workmanship is 1,2 %, material costs have increased by 6,3 %. (Figure 28.4).



**Figure 28.4.** Increase in the cost index for building (2005=100), 2011-2013.

Ref: <http://www.tuik.gov.tr>.

**Upward trend in current house prices:** Current house prices are continuing to increase yearly and rose by 17.4% in 2012. (Ref: Garanti Mortgage Reidin Real Estate Index). Parallel to this fact, house leases exhibited an increase of 15.8% throughout Turkey in 2012. This increase trend continued in all quarters of the year. Highest house lease increase was observed in İzmir with 20.8%. On the other hand, the highest increase was observed in 4+1 flats with 11.6%.

## 28.2. Regulations on sound insulation

There is no regulation regarding building acoustics issued in Turkey so far, however the By-law on environmental noise control, issued first in 1986 and revised several times up to 2010, refers to the acceptable indoor noise levels ( $L_{eq,T}$  dBA) for various functional spaces in buildings. When demand comes from the constructors or owners for a study about sound insulation, an acoustic consultant decides the required performances for building elements based on the measurements and develops alternative solutions for airborne and impact noise through calculations. The By-law only mandates the insulation measurements and evaluations by referring to ISO 140 and ISO 717 and the calculations by applying EN 12354 if a complaint exists and if the indoor limit is exceeded. However most of the complaints and measurements are handled by non-acousticians or by the personnel from companies marketing various insulation materials. The

new regulation specifically dealing with sound insulation is being prepared by the Ministry of Environment and Urban Planning.

### *Regulation relative to noise control referring briefly also to sound insulation*

- By-Law titled "Assessment and Management of Environmental Noise", issued by the Ministry of Environment and Urban Planning in 2010 (The first regulation entitled "Noise Control By-Law", was published in 1986.)

### *Building regulations not relative to sound insulation*

- Turkish Construction Law: 1985
- Condominium Law No. 634 with a new Law No. 5711, 2007
- Building Inspection Law, 2001
- Fire Control By-Law
- Thermal Insulation By- Law
- Building Material By-Law
- Others

## **28.3. New build housing constructions**

### *Multi-storey housing*

During the 1960-1990's the cooperative buildings of 4-5 floors were seen throughout the country and that was a new trend with the availabilities of housing credit from banks. However the rapid rise in land prices due to this urbanization process was inevitable, thus the legislations were changed so as to allow the high-rise apartment buildings. After 2000, the limitations regarding the height of buildings almost disappeared and the multi-story residential blocks were built destroying the major urban plans and without paying attention to the sub-structures even in the major cities. The former cooperative buildings were reinforced concrete frame system, although some were load-bearing masonry from bricks. The modern structures are also reinforced concrete but applying higher technology, e.g. pre-cast concrete floors allowing larger spans, prefabricated floor units, earthquake controlled foundations, etc. Steel structures are implemented for department stores or office buildings, but are used also on the upper floors of some high-rise residential blocks. The external walls are clad by composite panels, e.g. glass reinforced concrete (GRC) with a layer of

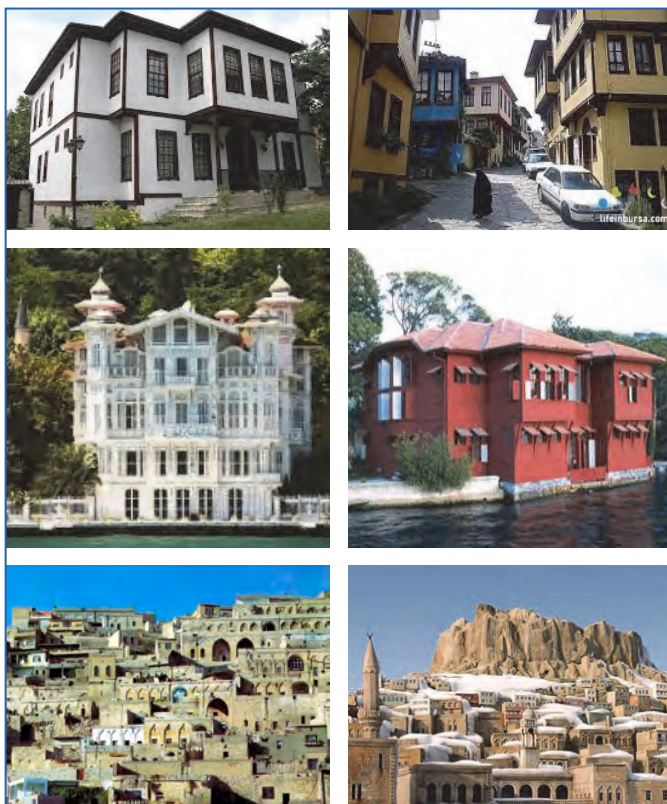




thermal insulation and a gypsum board on the inner side. The windows are double glazed without much considering the outside noise but applying the regulation requirements for thermal insulation. Some typical constructions are given in Figures 28.7-28.10. Inner walls are made of light concrete units (mostly as mechanical room walls, bathroom walls etc) and gypsum board constructions according to the advice of manufacturers.

### *Typical heavy constructions*

As mentioned above, heavy walls are not implemented much except the load-bearing structural elements made of reinforced concrete of up to 40 cm thick



**Figure 28.5.** Examples of traditional houses (first row (1,2): Bursa, Marmara region -Wooden frame and mud- brick filling+ plaster. Second row (3,4): Bosphorus mansions (yalı) in Istanbul -Wooden constructions. Third row (5,6): Stone houses in Urfa and Mardin (South eastern). Ref. [3].



(around elevator shafts and staircases or fire resistant dividing walls). Masonry cavity walls of aerated concrete blocks with a gap of 100 mm can be seen in the generator rooms, however without paying attention to the joint details. Bricks which were manufactured in different types in the past, such as solid, hollow and thermal bricks, were almost abandoned for the sake of lightweight systems.

### *Typical light-weight constructions*

Gypsum walls are rather common in modern residential buildings using various types of such constructions according to the function of spaces. The



**Figure 28.6.** Samples of the building sites. First row (1,2): Mass houses built by Government (TOKI) especially in earthquake regions and urban transformation areas (concrete frame and all walls of gas concrete). Second row (3,4): New suburban neighbourhoods (buildings with concrete frame and gas concrete walls, some gypsum board interior walls). Third row (5,6): High-rise residential blocks in Istanbul (curtain walls, some steel framed, interior walls of gypsum board constructions). Ref. [4].

decisions are made based on the manufacturer’s documents and advice, without caring about attachments, joints etc. Since there is no regulatory requirement on sound insulation, the efficiency of implementations is not confirmed by field tests.

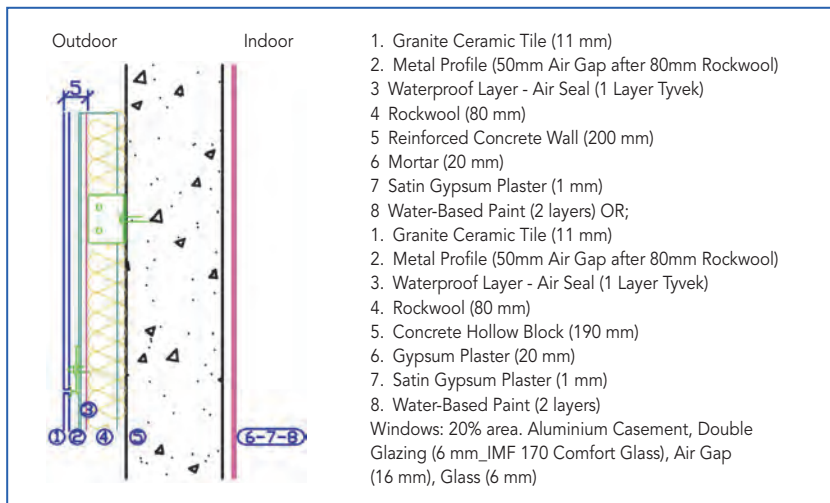


Figure 28.7. A sample external wall detail in a new residential building [1, 2].

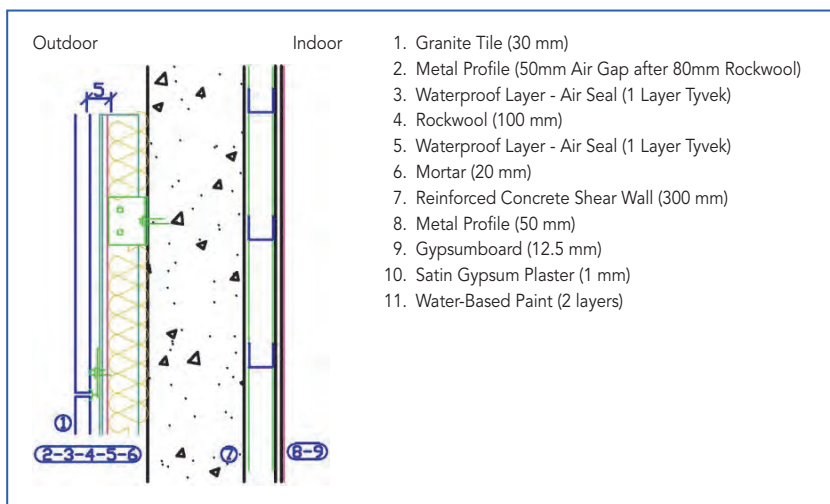


Figure 28.8. A sample external wall detail in a new residential building [1,2].

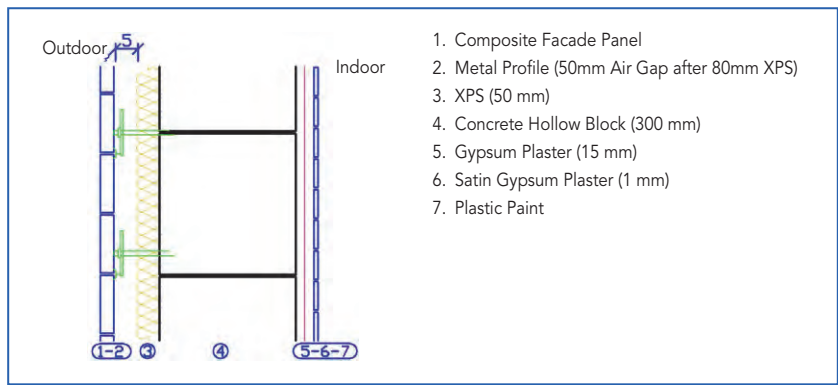


Figure 28.9. A sample external wall in a new residential building [1,2].

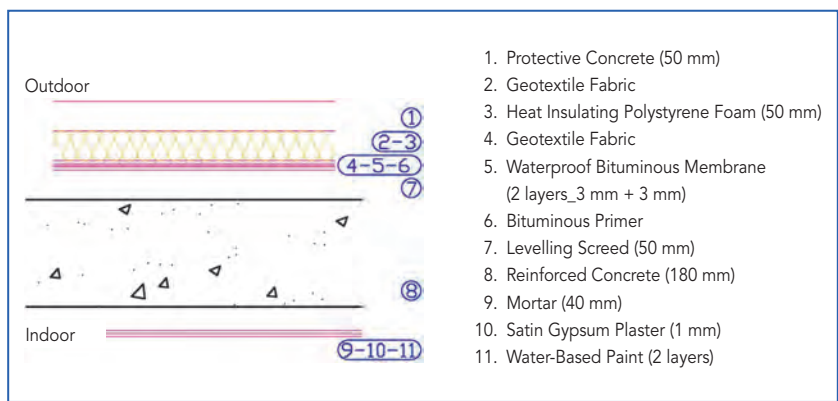


Figure 28.10. A typical roof detail in new residential buildings [1, 2].

**Typical errors in design and workmanship (from the standpoint of acoustic performance)**

Under the conditions explained above, the errors are inevitable and the typical ones are summarized below:

1. The issue causing most complaints is the impact noise from the upper floor, i.e. walking noise and children running. Lack of insulation on the floor for impact noise is an important issue. The reason is that the floors made of 20 cm thick concrete and with hollow blocks without using thick cover, typical of cooperative houses or individual apartment buildings. Nowadays, the floor thicknesses are greater due to the floor

- heating systems and the floating floors implemented in the new buildings.
2. During construction of the lightweight gypsum board walls, various construction errors (leaving gaps, cracks, not using resilient layers underneath the wall and in the junction between the ceiling and wall etc.) are observed.
  3. AC units on the external walls without inner lining and pipe wrapping
  4. Bare wooden floors with thin kilim, a type of rug in southern buildings
  5. Holes and cracks on masonry wall surfaces covered only by plaster
  6. Sanitary pipes connected directly on the bedroom walls
  7. Bedroom wall adjacent to closet (reservoir) of another flat's bathroom
  8. Noisy public spaces located at the roof floor and entrance lobbies without ceiling treatment to absorb sound
  9. Gypsum double wall construction is destroyed after completion for placement of fire cabinet (in apartment corridors), electrical sockets, even water closet reservoirs.
  10. Shaft walls are adjacent to bedrooms and without lining on the inner surfaces
  11. Noisy mechanical equipment located in the basement and roof
  12. Unsealed windows
  13. Errors in the joints between external walls and floors
  14. Façade panels placed without attention to sound insulation
  15. Generally design faults in architectural space planning

Weaknesses and problems cannot be displayed by the photographs since they are not available at the moment.

#### **28.4. Existing housing**

Squatter (gecekondu) housing is being demolished mostly because of earthquake risk and new apartment blocks are being built by TOKİ (governmental institution), private companies or by owners themselves. The cooperative buildings of 4-5 floors still exist throughout the country.

### Typical constructions found in existing stock:

Older housing blocks up to 5 floors: Structure: reinforced concrete, external and internal walls were masonry made of 23, 19 cm, 13.5 and 8.5 cm bricks. Later 20 cm cemented blocks were implemented. Single glazing was all replaced by double glazed thermal windows.

Newer housing blocks with 6 floors or more: Reinforced concrete structures, some uses tunnel formwork and precast elements, facades are 20 cm thick aerated concrete or prefabricated panel systems, the inner walls are gypsum-board constructions, windows are thermally insulated.

### Typical performance (sound insulation: values and graphs)

There is not reliable data base regarding the results of field tests. Some of the test results could not be obtained due to the big competition in the housing sector. However the evaluations through predictions made in the national research project conducted in Turkey are given below: Some measurement results obtained by Kurra are also displayed in Figures 28.11-28.17.

### Important features during improvements and brief check lists

Increase in building costs due to the extra insulation and labour time prevents owners and constructors from taking precautions on building sites, if they are not planned before. Since there is no obligation of checklist and mandatory tests for sound insulation, the applications are performed upon demand by those who are not experts or trained in acoustics. For the existing

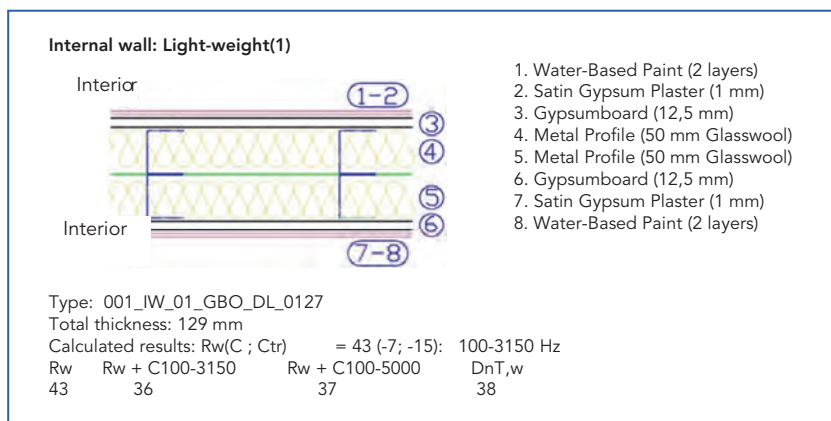


Figure 28.11. Light-weight wall. Construction details and sound insulation data.

buildings even if the tenant or house owner complains about noises from a neighbour, generally the renovation to improve the insulation is not accepted and the conflict ends up either at the court or moving house.

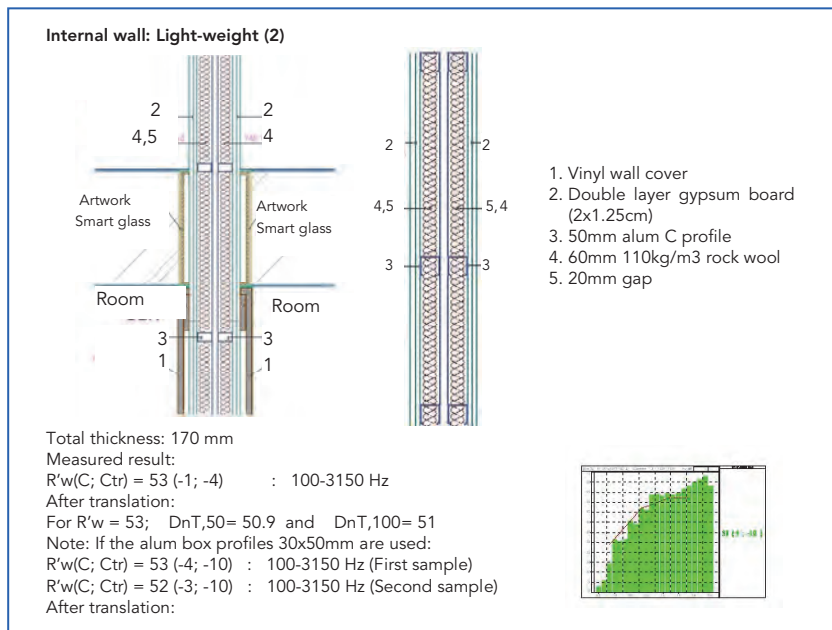


Figure 28.12. Light-weight wall. Construction details and sound insulation data.

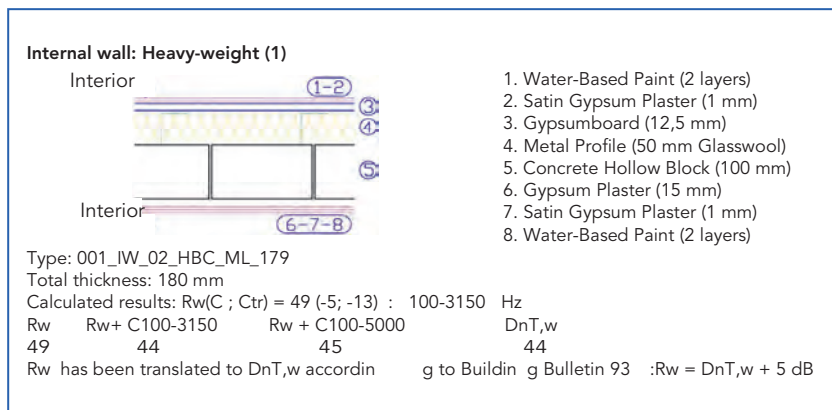


Figure 28.13. Heavy-weight wall. Construction details and sound insulation data.

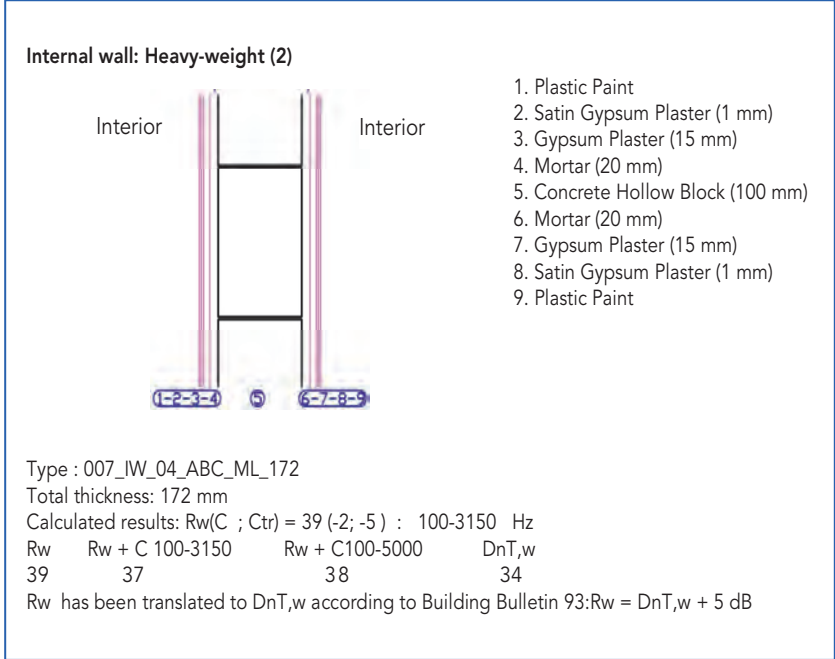


Figure 28.14. Heavy-weight wall. Construction details and sound insulation data.

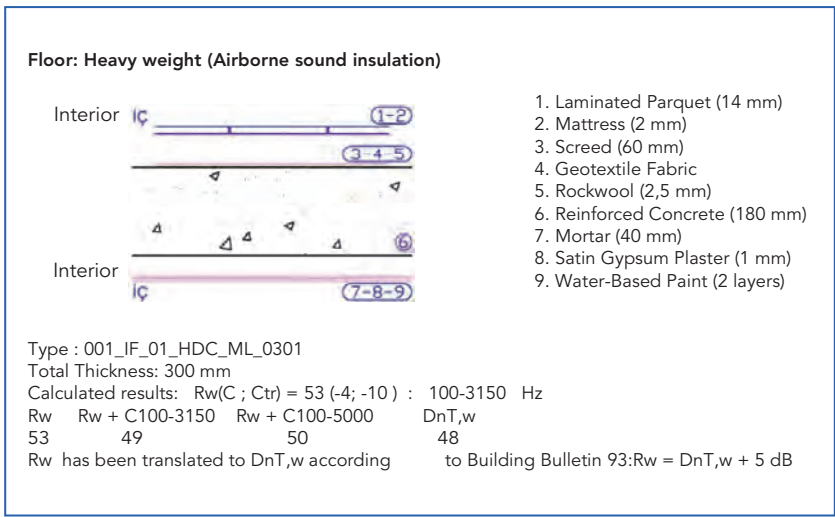
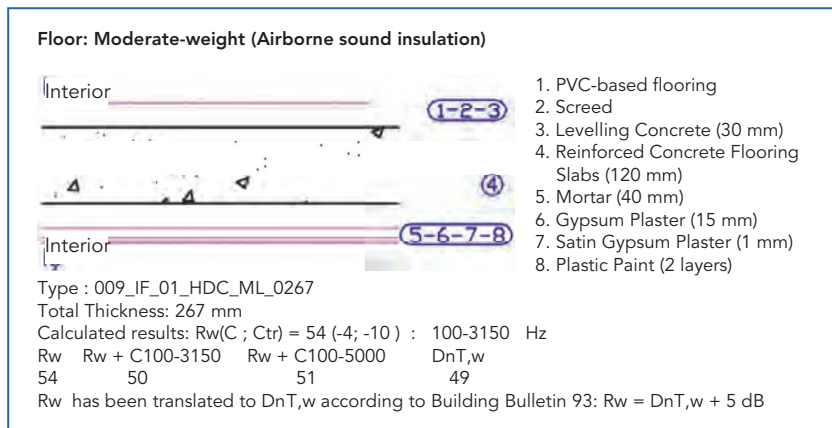
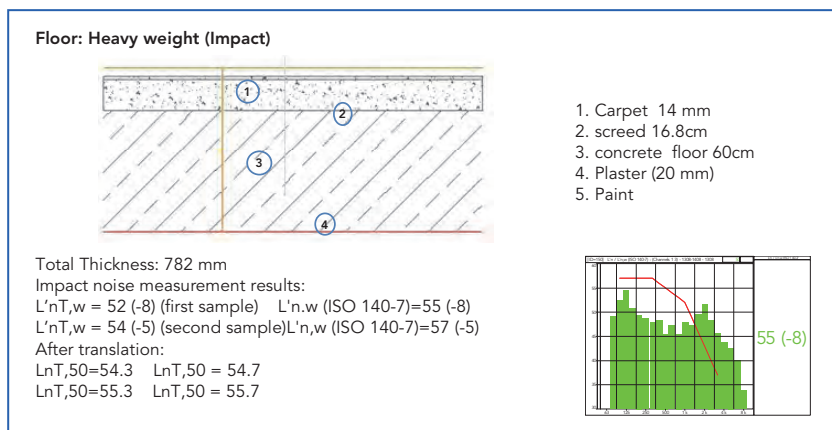


Figure 28.15. Heavy-weight floor. Construction details and sound insulation data.





**Figure 28.16.** Moderate-weight floor.  
 Construction details and airborne sound insulation data.



**Figure 28.17.** Heavy-weight floor.  
 Construction details and impact sound insulation data.

## 28.5. The possible effects of COST TU0901 project in Turkey

The results of the COST TU0901 project will certainly have a great momentum into the preparation of the new Turkish regulation dealing with all the sound insulation issues specifically. The proposed descriptors and the classification systems will be adopted in the regulation after

extensive discussions with the Universities and the representatives of the building sector. Besides it is necessary to conduct sufficient investigations while developing the sound insulation requirements and minimum categories applicable for residential buildings in Turkey.

## 28.6. References

- [1] S. Kurra (Project coordinator), Investigation of Sound Insulation Descriptors and Insulation Categories for Turkey Based on a Field Study, Project Report No: 111M784 (supported by TUBITAK) March 2013
- [2] S. Kurra, F. Demirel, G. Ilisulu, "Determination of Sound Insulation Performances and Categories For Building Elements In Turkey", National Congress on Acoustics organized by Turkish Acoustics Society, Dec. 2013 Istanbul.
- [3] References for photos in Figure 28.5:
  1. <http://akifim.blogcu.com/bursa-safranbolu-evleri/7613151>
  2. [http://www.lifeinbursa.com/fotografx/40/3708/Tarihi%20yap%C4%B1lar/bursa\\_evleri.htm](http://www.lifeinbursa.com/fotografx/40/3708/Tarihi%20yap%C4%B1lar/bursa_evleri.htm)
  3. [http://wowturkey.com/t.php?p=/tr155/Aydinsert\\_camili\\_yali.jpg](http://wowturkey.com/t.php?p=/tr155/Aydinsert_camili_yali.jpg)
  4. <http://www.renovanews.com/haberdetay.asp?id=993>
  5. Ministere Du Tourisme De la Republique de Turque- Direction Generale de l'Information, APA offset Basımevi San.ve Tic.A.Ş. 1992.
  6. [http://www.google.com.tr/imgres?imgurl=&imgrefurl=http%3A%2F%2Fwww.loadtr.com%2F203779-mardin\\_ta%25C5%25F\\_evleri.htm&h=0&w=0&sz=1&tbnid=O4LHa\\_V8k0yb2M&tbnh=194&tbnw=259&zoom=1&docid=oiZuPdQTB1UQ3M&ei=ZfHXUvDmKuKT0AXfzYcBg&ved=0CAgQsCUoAg](http://www.google.com.tr/imgres?imgurl=&imgrefurl=http%3A%2F%2Fwww.loadtr.com%2F203779-mardin_ta%25C5%25F_evleri.htm&h=0&w=0&sz=1&tbnid=O4LHa_V8k0yb2M&tbnh=194&tbnw=259&zoom=1&docid=oiZuPdQTB1UQ3M&ei=ZfHXUvDmKuKT0AXfzYcBg&ved=0CAgQsCUoAg)
- [4] References for photos in Figure 28.6:
  1. [http://www.google.com.tr/imgres?sa=X&rlz=1T4SKPB\\_enTR268TR268&biw=1272&bih=805&tbn=isch&tbnid=BgFj-RSGIQzlcM:&imgrefurl=http://www.tokitoplukonut.com/etiket/toki-bursa-hamitler-2013&docid=0RyWMAfeiZvlaM&imgurl=http://www.tokitoplukonut.com/resimler/toki-k%C3%BCTahya1.jpg&w=466&h=255&ei=TDJ1UrCUJ4OItQanzoGwCQ&zoom=1&iact=hc&vpx=2&vpy=521&dur=1359&hovh=166&hovw=304&tx=135&ty=143&page=2&tbnh=135&tbnw=259&start=27&ndsp=26&ved=1t:429,r:38,s:0,i:197](http://www.google.com.tr/imgres?sa=X&rlz=1T4SKPB_enTR268TR268&biw=1272&bih=805&tbn=isch&tbnid=BgFj-RSGIQzlcM:&imgrefurl=http://www.tokitoplukonut.com/etiket/toki-bursa-hamitler-2013&docid=0RyWMAfeiZvlaM&imgurl=http://www.tokitoplukonut.com/resimler/toki-k%C3%BCTahya1.jpg&w=466&h=255&ei=TDJ1UrCUJ4OItQanzoGwCQ&zoom=1&iact=hc&vpx=2&vpy=521&dur=1359&hovh=166&hovw=304&tx=135&ty=143&page=2&tbnh=135&tbnw=259&start=27&ndsp=26&ved=1t:429,r:38,s:0,i:197)
  2. <http://emlakfocus.com/2013/08/07/bingol-genc-toki-evleri-basvurulari/>
  3. <http://emlakkulisi.com/liva-sinpas-evlerinde-sifir-pesinatla-1260-tl-taksitle/16993>
  4. [http://www.emlakjet.com/haber/foto-galeri.php?imaj\\_id=10570#foto\\_td](http://www.emlakjet.com/haber/foto-galeri.php?imaj_id=10570#foto_td)
  5. <https://www.projepedia.com/sirket/ant-yapi/projeler/anthill-residence,69.html>
  6. <http://www.insaatdergisi.com/insaat-agaoglugmyworld-haberayrinti-21677-konut.html>



# Building acoustics throughout Europe

## Volume 2: Housing and construction types country by country

# 29

## United Kingdom

Authors:  
**Sean Smith<sup>1</sup>**  
**Ed Clarke<sup>2</sup>**

<sup>1</sup> Institute for Sustainable Construction, Edinburgh Napier University, UK  
e-mail: [se.smith@napier.ac.uk](mailto:se.smith@napier.ac.uk)

<sup>2</sup> Clarke Saunders Associates, UK  
e-mail: [eclarke@clarkesaunders.com](mailto:eclarke@clarkesaunders.com)



## CHAPTER

## 29

## United Kingdom

## 29.1. Design and acoustic performance: United Kingdom

### Overview of housing stock

In this chapter a review of the housing stock profile is provided along with the proportion of housing stock by dwelling type.

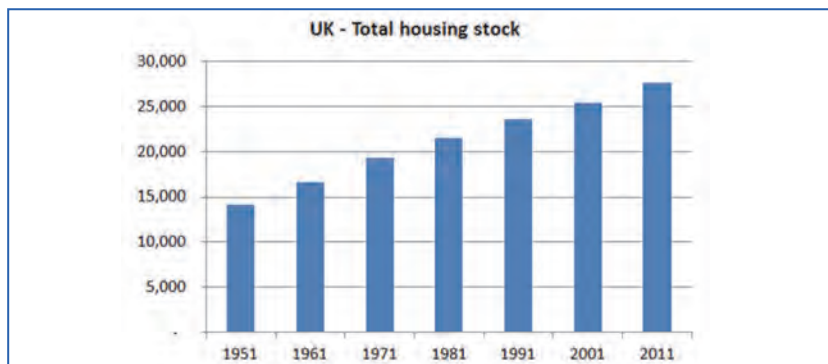
The United Kingdom is composed of four nations England, Scotland, Wales and Northern Ireland and the characteristics across the housing stock can be quite different in relation to construction form and dwelling type.

Some key statistics and characteristics are summarised below:

The UK housing stock is composed of over 27 million dwellings [1]

- 20% of housing stock is apartments/flats\*
- 55% of housing stock is semidetached or row / terrace
- 25% of housing stock is detached

Figure 29.1 shows the increase in total housing stock across the UK during the last seven decades.



**Figure 29.1.** Increase in UK total housing stock dwellings (thousands) from 1951 to 2011 [1].

\* Flats is another common term in the UK for apartments.

Across the UK there is variation in the proportion of apartments / flats. Figure 29.2 shows the percentage of apartments / flats which are found in each of the 4 nations.

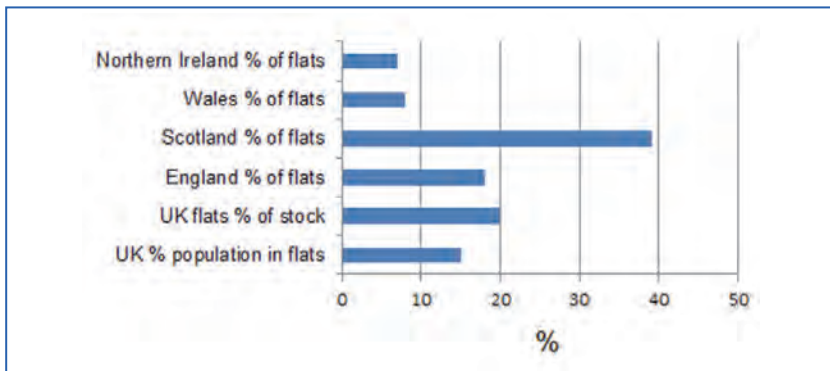


Figure 29.2. Variation in percentage of flats/apartments across the UK four nations.

Scotland has the highest proportion of apartments/flats at 38% compared to Northern Ireland at 7% and the average across the UK is 20%. Approximately 15% of the UK population live in flats/apartments. Annual new build housing 1990-2011 is shown in Figure 29.3.

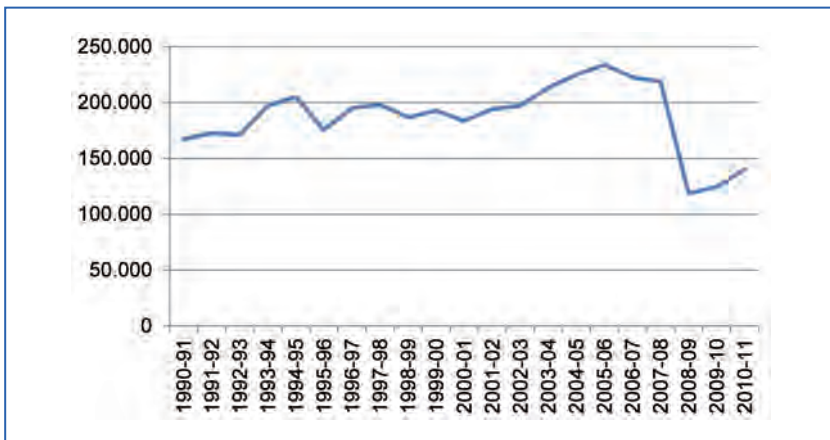


Figure 29.3. Annual new build housing supply across UK 1990-2011 [2].



The following pictures provide examples of some of the UK housing stock.



*Figure 29.4. Examples of UK housing stock.*

## 29.2. Building regulations and sound insulation

### 29.2.1. England and Wales

Following the Great Fire of London, a Royal Proclamation was issued in 1666, followed by the Fire Prevention (Metropolis) Act of 1774, requiring building to have brick or stone external walls and separating walls between dwellings.

Throughout the 1800s various recommendations emerged on suitable constructions to resist sound transmission, including work from Professor Faraday and Dr Reid, summarised in 1844 by Bill Allen in the First Report of the Commissioners for Inquiring into the State of Large Towns and Populous Districts.

The first specific performance recommendations came from the Committee on Sound Insulation and Acoustics of Buildings report of 1942 which suggested a performance for party walls of about '55dB' (parameter not specified), which also stated that a 9inch brick wall provided 'about 50dB'.

The Building Research Establishment conducted research, site testing and social surveys throughout the 1950s and 1960s which led to the first national regulations in 1965 which described 'deemed to satisfy constructions'.



This was augmented with the introduction of performance standards in 1972, which were revised in 1976 and finally issued as an Approved Document under the Building Regulations in 1985.

In 1992 a revision which extended the regulations to cover converted dwellings too, but only with the 2003 revision, which introduced compulsory post-completion testing for the first time. This had a positive impact on the levels of site compliance. Sound insulation between dwellings until that point had been one of the major issues for complaints from residents.

Compliance limits for England and Wales were introduced in 2003 at the following thresholds:

*Houses and flats (new build).*

- Walls  $D_{nT,w} + C_{tr}$  45dB (min)
- Floors  $D_{nT,w} + C_{tr}$  45dB (min)  $L'_{nT,w}$  62dB (max)

*Houses and flats (conversions).*

- Walls  $D_{nT,w} + C_{tr}$  43dB (min)
- Floors  $D_{nT,w} + C_{tr}$  43dB (min)  $L'_{nT,w}$  64dB (max)

*Rooms for residential purposes (eg hotels, student and nurses accommodation, etc.).*

- Walls  $D_{nT,w} + C_{tr}$  43dB (min)
- Floors  $D_{nT,w} + C_{tr}$  45dB (min)  $L'_{nT,w}$  62dB (max)

*Rooms for residential purposes - conversions.*

- Walls  $D_{nT,w} + C_{tr}$  43dB (min)
- Floors  $D_{nT,w} + C_{tr}$  43dB (min)  $L'_{nT,w}$  64dB (max)

### 29.2.2. Scotland

Whilst byelaws included some requirements for sound insulation, it was not until publication of the Technical Memorandum 3 'Sound Insulation in Houses' in 1957 that full guidelines for sound insulation were made available. This Technical Memorandum was published by the Department of Health for Scotland.

Following the recommendations of the Guest Committee, which informed the Building (Scotland) Act 1959, national unified standards were introduced in Scotland in 1963 and later consolidated in 1971. The Regulations were revised in 1981 but were effectively the same as those published in 1971 as regards sound insulation.



In 1984 a legal judgement (Scottish Special Housing Association v City of Glasgow District Council) stated that sound insulation tests could be used “as a means to determine whether the workmanship was satisfactory”. This then allowed Scottish Building Control departments the potential to request a sound insulation test be undertaken on any attached new build dwelling or conversion. Prior to 1987, the method used to calculate the sound insulation performance was the Aggregate Adverse Deviation (or AAD). In 1987 new methods were introduced to the Regulations for the pass/fail criteria and were changed from the AAD scale to  $D_{nT,w}$  for airborne sound and  $L'_{nT,w}$  for impact sound assessment. The new measurement criteria weakened the impact sound insulation (footstep noise) performance levels. The Technical Standards (1990) Part H: Resistance to the Transmission of Sound were updated but the criteria were very similar to those of 1987. These were superseded in May 2005 by the Technical Handbooks, with ‘Section 5: Noise’. The sound insulation performance requirements for attached dwellings were not altered, however, the primary change being a move from prescriptive (‘deemed to satisfy’) constructions to ‘guidance’ [3].

In 2010 ‘Section 5: Noise’ [4] airborne and impact requirements were significantly increased with absolute minimum (airborne) and maximum (impact) requirements (BSD, Section 5: Noise). In 2011 mandatory sound insulation testing was introduced for new build housing and alternative “robust details for Scotland” [5] were also introduced (RD Scotland).

**Table 29.1.** Comparing sound insulation criteria in Scotland 1987 onwards.

Historical Criteria	Airborne sound insulation ( $D_{nT,w}$ )	Impact sound transmission ( $L'_{nT,w}$ )
2010 onwards – Section 5: Noise	Min. 56 dB (W+F)	Max. 56 dB (F)
2005 to 2010 – Section 5:Noise	Mean 53dB (W)	
1987 to 2005 – Part H: Resistance to transmission of sound (Mean result from maximum 4 tests)	Absolute Min 49 dB Mean 52dB (F) Absolute Min 48 dB	Mean 61 dB (F) Absolute Max. 65dB

Note: W = Separating walls; F = Separating floors.

### 29.3. Typical heavyweight constructions - Walls

The two most common forms of separating wall are solid and cavity blockwork walls and represent 70% of all new housing. The range of materials used for such walls includes:





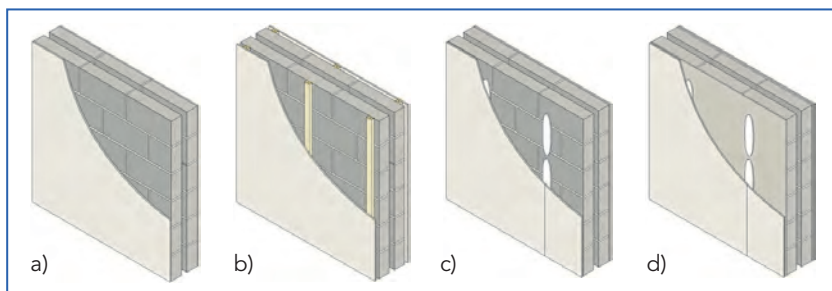
- aircrete (density of 600-850kg/m<sup>3</sup>);
- LWA - lightweight aggregate (density of 1350 – 1600 kg/m<sup>3</sup>); and
- dense aggregate (density 1800 – 2100 kg/m<sup>3</sup>).

Note: *aircrete blocks are predominantly made from coal power station waste products such as pulverised fuel ash.*

For cavity walls the core construction is two leaves of 100mm blockwork separated by a cavity. The cavity creates an isolation (or decoupling) layer. Whilst the overall mass of solid and cavity walls may be similar, this isolation means that the sound insulation performance of cavity walls is often better than solid walls.

Isolation is the most effective ingredient towards good sound insulation performance. Masonry cavity walls regularly outperform solid walls. In addition mass is not always that important for cavity walls. This is demonstrated by the higher sound insulation performance of aircrete cavity walls than dense block solid walls.

Wall ties are inserted in cavity walls to brace and stiffen the wall leaves for structural reasons. However, the structural connection formed by the ties can lead to a reduction in sound insulation performance. As well as transmitting sounds like speech, wall ties create a bridge for mortar droppings to collect on, which can further reduce performance. Separating wall cavities of less than 75mm are more likely to lead to the collection of mortar on wall ties. Typically in 2013 most cavity masonry blockwork separating walls now have 100mm cavities and are fully filled with mineral wool to reduce cavity heat loss, which also improves sound insulation performance. Figure 29.5 below shows examples of some of the blockwork cavity walls.



**Figure 29.5.** Typical blockwork cavity separating walls found in the UK :  
a) plaster finish ; b) strap and lined with gypsum board ; c) gypsum board on dabs ; d) 8mm parge coat with gypsum board on dabs [3].



In the late 1970's and early 1980's pilot sound tests were undertaken involving internal renders also known as "parge coats". Using a sand:cement mix, these coats (8mm to 13mm thick, applied to the room side of the blockwork) could improve the performance of blockwork walls, specifically for speech frequencies. Many parge coats are now supplied pre-mixed in bags for ease of application on site.

### 29.3.1. Typical errors found in cavity walls

When built correctly blockwork walls with a range of finishes can perform very well, however, areas of weakness include:

- core construction – incorrect blockwork density;
- junction designs – running the inner leaf of the external wall through, dwelling to dwelling, past the separating wall, creating strong flanking path;
- insufficiently filled mortar beds;
- wrong wall ties; and
- mortar collection on wall ties and not being cleaned off (as shown below in Figure 29.6).



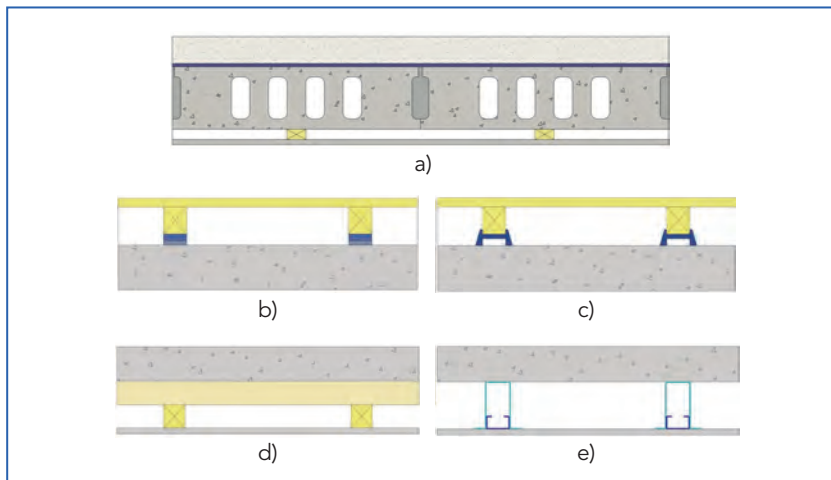
**Figure 29.6.** Example of poor workmanship in cavity separating walls, showing incorrect wall ties and also mortar being allowed to collect on ties (these provide strong acoustic bridges which weaken the sound insulation performance by 6 dB to 10 dB).

## 29.4. Typical heavyweight constructions - Floors

The most common form of separating floor in the UK utilises precast concrete floors slabs typically 150 mm to 200 mm thick with a minimum



mass per unit area of  $300\text{kg/m}^2$ . Floor finishes may include floating screeds isolated on resilient layers, floating timber floor finishes on resilient battens or cradles with various timber or metal frame ceiling supports as shown in Figure 29.7.



**Figure 29.7.** Examples of precast concrete separating floors [3] used in the UK with a) screed finish on isolating layer; b) use of resilient flooring battens; c) use of resilient cradle floor deck systems; d) Timber counter strapped ceiling frames; e) metal frame ceilings. (Note: primary resilient zones shown in dark blue).

#### 29.4.1. Typical errors found in apartment concrete floors

The typical errors which can occur in the construction of concrete precast floors involve the core floor, isolation of floating screeds or floating floor systems. These can be summarised as:

Common errors in precast concrete wide slabs include:

- Slab joints not fully grouted and sealed,
- Not building into the perimeter walls – thus creating strong flanking paths,
- Using a slab with too low a mass (i.e. less than  $300\text{kg/m}^2$ ),
- Not sealing the small void created by the camber (where slab mid-span rises/curves slightly vertically) at the slab & wall head junction.

Common errors found for flooring screeds with isolating layers include:

- Single isolating layers can be easily torn or damaged on site – depending on material used,
- Isolating layers can be poorly installed and do not fully cover the surface of the floor,
- Joints in isolating layers may not overlap,
- Gaps remained where isolating layers were turned-up at the perimeter walls that allow the screed to come into contact with the walls,
- Penetration of the isolation layer by pipes and fixings for underfloor heating that allow bridging of the isolating layer.

Common errors found in floating floor treatments in existing dwellings include:

- Mineral wool placed underneath battens which deteriorated over time,
- Omission of flanking strips at floor edge and wall perimeters allowing impact sound (footstep noise) to flank into dwelling below,
- Use of nails or screws that are too long and bridge the resilient layer creating direct contact between batten and core floor structure,
- Services being installed under battens, reducing resilient layer thickness and bridging of batten to the base floor,
- Confusing high load bearer battens with normal resilient battens

Note: *high load battens which have less resilience are commonly inserted under floor zones with higher loads, such as under kitchen units where household appliances are positioned or in bathrooms under baths and showers.*

## 29.5. Typical sound insulation performance

The concrete block work cavity walls and aircrete blockwork cavity walls have similar performances on site as shown below in Table 29.2 with precast floor shown in Table 29.3.

**Table 29.2.** Typical sound insulation performance of UK blockwork walls.

Construction of cavity walls	$D_{nT,w}$	$C_{tr}$
Aircrete 100mm block twin leaf wall, 75mm cavity	59 dB	- 6 dB
LWA 100mm block twin leaf wall, 75mm cavity	60 dB	- 8 dB
Dense block aggregate twin leaf wall, 75mm cavity	61 dB	-7 dB

Note: *all walls have 8 mm parge coat with 12.5 mm gypsum board on plaster dabs.*



**Table 29.3.** Most common separating precast concrete floor performance.

Construction	$D_{nT,w}$	$C_{tr}$	$L'_{nT,w}$
150mm precast floor with 65mm screed on isolation layer, supported by 100mm LWA blockwork walls, 12.5mm plasterboard ceiling on 150mm metal frame	59 dB	- 6 dB	54 dB

## 29.6. Timber frame construction

Timber frame construction accounts for 18% of UK housing output and accounts for 70% of housing output in Scotland. Timber frame separating walls are normally composed of two panels formed from timber 'studs' supported off timber sole plates and are closed by a head plate.

The studs are typically 100mm x 50mm with the frames separated by a 30-50mm cavity. Some frames may be smaller such as 89mmx45mm and frame separation can be 20mm. The studs may be spaced at 300mm to 600mm centres depending on loading. 'Dwangs' may be used to stiffen the stud frames. In addition, cross bracing is quite common with small metal ties bridging the studs.

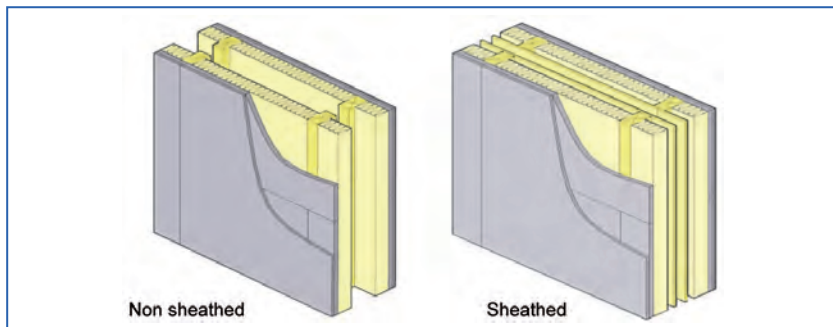
Frames are sometimes strengthened by a sheathing board (timber boarding), which is mounted on the cavity side. The sheathing board splits the core wall into multiple cavities. Mineral wool is commonly placed on each side of the twin frames and typically minimum 60mm thick.

Timber frame separating walls are commonly finished with two or more layers of gypsum based board with staggered joints. The thickness of each layer ranges from 10mm to 19mm and typical two layer linings are 19mm and 12.5mm gypsum board or 2 layers of 15mm gypsum board, each side.

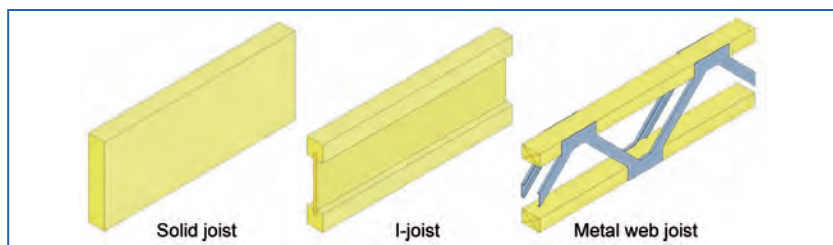
Timber frame separating walls are either sheathed or non-sheathed (using minimum 9mm timber boarding), depending on structural racking strength requirements and sheathed walls are now the most common construction, as shown in Figure 29.8.

### 29.6.1. Timber frame separating floors for apartments

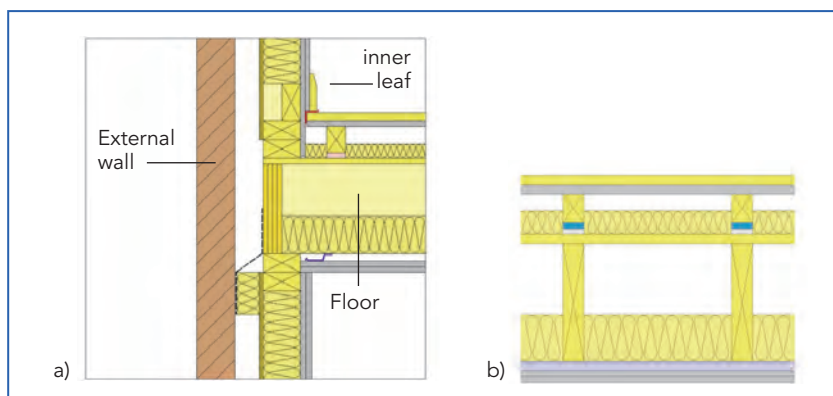
Separating floors with solid joists have been commonly used for many years. Joist depth typically varies from 220mm to 240mm and spaced at 300mm to 600mm centres. More recently, timber core floor design has diversified into a variety of other materials and engineered solutions, such as engineered 'I-joists' and metal web joists. Depths are typically 220mm to 302mm for 'I-joists' and commonly 253mm for metal web joists. Examples are provided in Figure 29.9.



**Figure 29.8.** Examples of twin frame timber frame separating walls non-sheathed and sheathed.



**Figure 29.9.** Examples of separating floor joists used in the UK.



**Figure 29.10.** a) Junction with external wall. b) Section of separating floor.

Figure 29.10a shows the cross section of the separating floor and how this junctions with the inner leaf of the external wall. Figure 29.10b shows the



cross section of the floor which is built using 16mm resilient ceiling bars to support the ceiling, floating resilient battens with a layer of 19mm gypsum and 18mm wood fibre board above.

### 29.6.2. Typical errors found in timber frame systems

Typical errors in timber frame construction can include:

- Mounting of timber frame twin walls too close together - reducing cavity width and reducing low frequency performance
- Accidentally bridging twin leaves with rigid cavity closure boards
- Use of incorrect ceiling board screw fixings for resilient ceiling bars which are too long - these bypass the resilient bar and couple directly to the joist
- Non-installation of flanking strips at the edge of floor boards – thus coupling floorboards to perimeter walls.

### 29.7. Typical sound insulation performance

The typical sound insulation performance of the timber frames constructions most commonly used in the UK is shown below in Table 29.4 for separating walls and Table 29.5 for separating i-joist floors.

**Table 29.4.** Typical sound insulation performance of UK timber separating walls.

Construction of cavity walls	$D_{nT,w}$	$C_{tr}$
Timber non-sheathed wall (240mm between gypsum layers)	61 dB	- 9 dB
Timber sheathed wall (240mm between gypsum layers)	63 dB	- 10 dB

Note: all walls have 60mm mineral wool (each side) and 2 x 15mm gypsum board.

**Table 29.5.** Typical sound insulation performance of UK timber separating floors.

Construction	$D_{nT,w}$	$C_{tr}$	$L'_{nT,w}$
18mm board, 19mm gypsum, 70mm resilient battens, 25mm insulation, 18mm subdeck, 240mm i-joist floor,	59 dB	- 6 dB	54 dB
100mm insulation, 16mm resilient bars, 2 x 15mm gypsum			

## 29.8. Pre-completion Testing approach in the UK

In 1999 Noise complaints in housing were at a record high as outlined in the government consultation in 2001 for “Part E of the building regulations”. Historic poor compliance levels for sound insulation standards (e.g. 40% floors and 25% walls) had been identified by Department of Environment Transport and Regions, BRE previous research and Scottish Executive.

Prior to the 2003 revision even the best estimates of compliance rates were less than 75% for walls and 60% for floors. It was also felt that improved low frequency performance was necessary for modern lifestyles, and the opportunity was taken to introduce regulations in other areas of interest (internal walls and floors, reverberation in common areas, and acoustic conditions in schools).

It became apparent at this time that there would not be enough UKAS accredited testers (United Kingdom Accreditation Service) to support the test market and could potentially undermine the introduction of the new regulation.

In close collaboration with the responsible government department, the UKs Association of Noise Consultants (ANC) devised an alternative scheme for its members, who were already expert acousticians, but held no external certification for sound insulation testing. The scheme involves approval of specific names individuals within registered test companies, whose tests and reports are regularly witnessed, audited and scrutinised. It has also led to the development of good practise guidance and round robin comparisons all of which help to maintain and improve standards within the industry.

This scheme was formally approved as an acceptable alternative by the UK government, and went live in early 2003 for the introduction of testing in converted dwellings.

Initially the testing requirement was introduced only for converted dwellings, in which it was accepted that the specific nature of each development did not lend itself to a ‘pattern book’ approach. Meanwhile, the UK government allowed a one year delay on the introduction of compulsory testing for all new build developments, following successful lobbying from the building industry whilst the robust standard details research project was being carried out (see section 29.9).

The House Builders Federation successfully argued that it would be preferable to put some of the resources otherwise allocated for the testing



programme into a more certain, tightly controlled and slightly over-engineered construction approach which could yield better certainty for the builder, higher compliance rates for the regulator, and ultimately, improved standards for the home owner.

Ten years after the introduction of compulsory testing, compliance rates in England and Wales are consistently well above 95% for both walls and floors, and even higher under the Robust Details Scheme at over 98%.

Both approaches have been shown to deliver impressive improvements in the performance of the housing stock in the UK, and have been heralded as major success stories by all of the stakeholders involved.

Another advantage of the organisation and collaboration between the UK Government, Robust Details Limited and the Association of Noise Consultants is the collection and preservation of a vast database of in-situ sound insulation test data from real constructions. The ANC database, as at the end of 2013, contains over 300,000 site sound insulation test results.

## 29.9. Robust Details approach in the UK

In 2001 Edinburgh Napier University had undertaken a research project to “Review sound insulation in domestic construction” funded by the Scottish Executive [6]. The analysis of high sound insulation performing walls and floors, coupled with previous investigations of complex sound transmission in buildings provided a unique research base.

Due to the future introduction of mandatory pre-completion testing as described in Section 1.8, the Home Builders Federation funded a research project to Edinburgh Napier University to develop Robust Standard Details (RSD). Key aims were to research and design robust separating wall and floors for attached houses and apartments to address a wide range of living noises, provide enhanced sound insulation, reduce complaints and deliver high level regulatory compliance rates as soon as possible. The RSD project involved 119 industry members, public sector and over 20 industry organisations.

The underpinning research involved using the Edinburgh Napier large scale database of on-site sound insulation measurements to identify key trends and weaknesses in existing construction designs and their performance. The research team analysed construction techniques that would deliver a safety margin for design, workmanship, technical compatibility with other regulations (e.g. structure) and enhanced

performance. Research was also undertaken to review the implications of International Standards, ISO 717 acoustic spectrum adaptation terms for airborne sound transmission. Using a statistical approach to deliver a 95% confidence of achieving enhanced +5 decibel sound insulation better than building regulations, the research team then designed a series of specifications for the house building industry to build and test.

During 2002-03 the industry built 1,400 new homes incorporating new acoustic robust designs by which were tested on site and the research team undertook computer modelling and empirical data analysis during the on-site period. The research project outcomes led to a public consultation by the Office of the Deputy Prime Minister [7]. During 2003/2004 the industry then funded further research for Edinburgh Napier University to develop compliance protocols and incorporation of a “no advance warning” robust site inspection scheme. Over 25 RD Inspectors regularly visit construction sites to inspect and carry out random sound tests to check compliance [8]. The inspectorate is drawn from accredited testers by UKAS and Approved testers under the Association of Noise Consultants.

Robust Details Ltd (RD) was formed in 2004 and has since been responsible for 65% of the attached housing designs in England and Wales. The RD approach has been instrumental in developing new standards for sound insulation leading to innovative knowledge transfer to industry via the robust details handbook. The compliance rates for sound insulation are now 99% and noise complaints in new dwellings have fallen four fold in 2010 when compared with previous noise complaint statistics in 2004. The quality of life for home occupants has been improved with the average sound insulation performance being 7 decibels above regulatory requirements which is similar to doubling the perceived sound insulation.

A key step change due to the industry involvement and support was the development of the Robust Detail design Handbook providing clarity of technical information, guidance and specifications. In the last five years between 2008 and 2013 there have been 1,900 site inspections and 6,000 on-site sample acoustic test undertaken which are entered into the UK's (and world leading) most in-depth sound insulation database. Over 1.2 million people in the UK now live in robust detail homes. Over 50 new innovative robust details using UK manufactured products have been developed delivering over 300 wall and floor combinations for architects and developers to specify in apartments.

In 2009 the Edinburgh Napier team were awarded the Queen's Anniversary Prize for "innovative housing for environmental benefit and quality of life" as a result of the original RSD research project.

In 2010 the Scottish Government also introduced mandatory pre-completion testing and new sound insulation performance requirements with additional technical guidance [9]. In 2011 the Scottish Government also adopted the robust details approach for sound insulation in new housing as an alternative to pre-completion testing, and a separate RD Handbook for Scotland was produced.

The significant sound insulation performance database that robust details operates has been influential in analysing proposed changes to ISO standards [10] and for assisting this COST Action TU0901.

## 29.10. Conclusion

The UK housing stock is quite varied and has regional variations in housing types and construction systems. The increase in sound insulation performance requirements has been helpful in improving the quality of life. However, the most important step changes were the introduction of mandatory testing and the introduction of robust detail solutions and checklists to assist the industry and knowledge transfer.

The involvement of key stakeholders from government, house builders, product manufacturers, local authorities, warranty providers and acoustic consultants have collectively provided a strong and robust platform that improves the quality of life for typically 200,000 new households annually.

## 29.11. References

- [1] CLG (Dept of Communities and Local Government). UK Dwelling stock (historical series) Live table 101: Dwelling stock by tenure. May 2013.
- [2] Housing data, ONS (Office of National Statistics), UK. [www.ons.gov.uk](http://www.ons.gov.uk)
- [3] S. Smith, J.B. Wood and R.G. Mackenzie. Housing and Sound insulation. *Improving existing attached dwellings and designing for conversions*. Scottish Government. Arcamedia, 2006. <http://www.scotland.gov.uk/Resource/Doc/217736/0099123.pdf>
- [4] BSD, Building Standards Division, Section 5: Noise. Technical Handbooks – Domestic, Scottish Government. 2010.
- [5] Robust Details Scotland, RD Handbook. Robust Details, 2011. [www.robustdetails.com](http://www.robustdetails.com)

- [6] R.S. Smith, R.G. Mackenzie, R.K. Mackenzie and T. Waters Fuller. A review of sound insulation in Scottish domestic construction. Part 1 - Building Standards Division, Scottish Executive. March, 2001.
- [7] R.S. Smith, J.B. Wood, R.G. Mackenzie and R.K. Mackenzie. *The Building Regulations 2000 – Amendment of the building regulations to allow robust standard details to be used as an alternative to pre-completion testing*. Public Consultation Document. Office of the Deputy Prime Minister, UK Government. August, 2003.
- [8] R.S. Smith, D. Baker, R.G. Mackenzie, J.B. Wood, P. Dunbavin and D. Panter. *The development of robust details for sound insulation in new build attached dwellings*. Journal of Building Appraisal, 2 (1). pp. 69-85. ISSN 1742-8262, (2006).
- [9] R.S. Smith, J.B. Wood and R.G. Mackenzie. "Design of separating constructions that are resistant to the transmission of noise." Part 1 Main Report and Part 2 Example Details. Scottish Building Standards Agency (SBSA), Scottish Government. 2009.
- [10] C. R., A. Monteiro, C. Mondaca Marino, M. Machimbarrena, F. Torchia, E. Nannipieri, N. Robertson and R.S. Smith. Comparative analysis of airborne sound insulation field measurements using different ISO 717-1 performance descriptors – Lightweight separating walls and floors. Euronoise 2012, Prague, Czech Republic. 2012.

## 29.12. Useful bibliography / websites

- Robust Details: [www.robustdetails.com](http://www.robustdetails.com)
- Association of Noise Consultants: [www.association-of-noise-consultants.co.uk](http://www.association-of-noise-consultants.co.uk)
- Queens Anniversary Prize: Recognition by the Office of the Queen's Anniversary Prize 2009 for world-class excellence and achievement: [www.royalanniversarytrust.org.uk](http://www.royalanniversarytrust.org.uk)
- Feedback from the house building sector relating to the positive impact of the robust standard details research project: [www.hbf.co.uk/media-centre/news/view/queens-prize-recognises-pioneering-noise-research/](http://www.hbf.co.uk/media-centre/news/view/queens-prize-recognises-pioneering-noise-research/)
- COST Action related invited presentation in Milan, to Lombardia Region and Italian Acoustic Society <http://www.agendadigitale.regione.lombardia.it/shared/ccurl/120/328/Presentazione%20Smith.pdf>
- The impact of improved compliance and success of the robust detail scheme as reviewed by the department of Communities and Local Government [www.empublishing.co.uk/noise/noise18.pdf](http://www.empublishing.co.uk/noise/noise18.pdf)



# Building acoustics throughout Europe

## Volume 2: Housing and construction types country by country

# 30

## Australia

Author:  
**John Laurence Davy<sup>1,2</sup>**

<sup>1</sup> School of Applied Sciences, RMIT University, GPO Box 2476,  
Melbourne Victoria 3001, Australia  
e-mail: john.davy@rmit.edu.au

<sup>2</sup> CSIRO Materials Science and Engineering, PO Box 56,  
Highett Victoria 3190, Australia  
e-mail: john.davy@csiro.au



## CHAPTER

## 30

## Australia

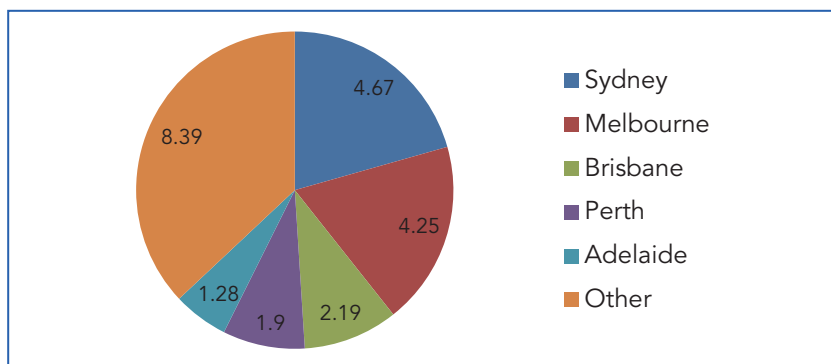
### 30.1. Introduction

New construction in Australia is regulated by the National Construction Code (NCC). The acoustical provisions are contained in the Building Code of Australia (BCA) which forms the first two volumes of the NCC. The NCC is developed by the Australian Building Codes Board (ABCB) [1]. However, the enforcement of construction requirements in Australia is the responsibility of the individual states and territories. Each state and territory has its own appendices in the NCC, which add, modify or remove requirements. It should be noted that these requirements only apply to new construction. The Association of Australian Acoustical Consultants (AAAC) [2] has introduced a star rating system for the acoustical performance of dwellings.

### 30.2. Overview of housing stock

#### 30.2.1. Population

At the 30 June 2012 the Australia population was 22.68 million. There were five cities with over one million inhabitants. These were Sydney 4.67 million, Melbourne 4.25 million, Brisbane 2.19 million, Perth 1.90 million and Adelaide 1.28 million. Australia is one of the world's most urbanised countries and most Australians live close to the coast.



**Figure 30.1.** Australian population in millions at 30 June 2012.

### 30.2.2. Housing stock

Most Australians live in separate houses on their own block of land. In 2001, 76 % of private dwellings were separate houses. 22% were higher density housing and 2% were classified as other dwellings. Between 1991 and 2001 the population increased 12% while the number of dwellings increased 21%. This resulted in the average number of people living in a dwelling falling from 2.7 to 2.6. Over the same period, the percentage of separate houses fell by 2% while the percentage of higher density housing increased by 2%. Between 1991-92 and 2003-04, the average number of new dwellings completed each year was 145,000. Over this period, 28% were higher density dwellings. In 2001, there were 7.07 million dwellings in Australia. Most of the dwellings in Australia are privately owned. The public housing stock was 0.31 million dwellings in 2006. The percentage of people living in apartment blocks of four or more stories increased from 1% in 1981 to 2% in 2001.

In 1999, 18% of Australia’s housing stock was less than 10 years old, and 55% was less than 30 years old. 12% of all occupied dwellings were aged 60 years and over.

### 30.2.3. Construction methods

Most Australian dwelling construction methods use solid brick, cavity brick, brick veneer, clad wood or steel frame, or post and beam. Traditionally

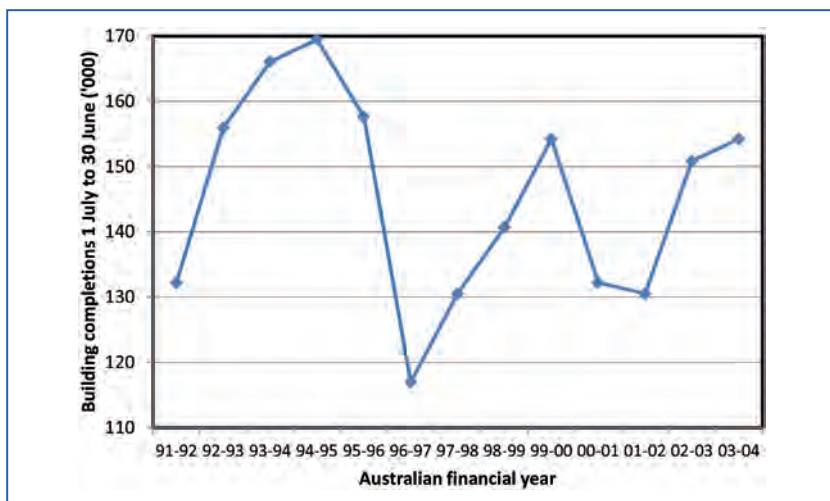


Figure 30.2. Building completions per Australian financial year.

**Table 30.1.** Number of different types of private dwellings.

Dwelling structure	1991	2001	Change 1991-2001
	%	%	%
Separate houses	78.0	75.9	17.5
Higher density housing	19.5	22.2	37.2
Semidetached, row or terrace house, townhouse etc.	7.8	9.0	39.6
Flat unit or apartment	11.7	13.2	35.6
Other dwellings	2.5	1.9	-6.1
<b>Total</b>	100.0	100.0	20.8
	'000	'000	'000
<b>Total</b>	5,852.5	7,072.2	1,219.7

most floors were wooden on wood or concrete stumps, but concrete slabs have become very popular. Factory manufactured roof trusses are now widely used. The roof cladding material is usually terracotta or concrete tiles or profiled steel sheets.

The wall cladding is normally bricks, weatherboards (including baltic pine, cedar, treated pine and cellulose fibre cement), sheets (including plywood, cellulose fibre cement or compressed wood fibre) or aerated concrete blocks or panels. Mud bricks, straw bale and rammed earth are also used. The wall cladding may also be rendered. The internal sides of walls and ceilings are usually clad in gypsum plaster board sheets.

### 30.3. Current acoustical requirements

#### 30.3.1. In-situ verification requirements-excludes aged care buildings

Walls and floor/ceilings between sole occupancy dwellings are required to have an in-situ  $D_{nT,w} + C_{tr}$  not less than 45.

Floor/ceilings between sole occupancy dwellings are required to have an in-situ  $L_{nT,w} + C_1$  of not more than 62.

Walls between a sole occupancy dwelling and a plant room, lift shaft, stairway, public corridor, public lobby or the like, or part of a different building classification, are required to have an in-situ  $D_{nT,w}$  of not less than 45.

Floor/ceilings between a sole occupancy dwelling and a plant room, lift shaft, stairway, public corridor, public lobby or the like, or part of a different



building classification, are required to have an in-situ  $D_{nT,w} + C_{tr}$  of not less than 45 and an in-situ  $L_{nT,w} + C_1$  of not more than 62.

Door assemblies between a sole occupancy dwelling and a stairway, public corridor, public lobby or the like are required to have an in-situ  $D_{nT,w}$  of not less than 25.

### 30.3.2. Habitable room

A habitable room means a room used for normal domestic activities,  
and

(a) includes a bedroom, living room, lounge room, music room, television room, kitchen, dining room, sewing room, study, playroom, family room, home theatre and sunroom;

but

(b) excludes a bathroom, laundry, water closet, pantry, walk-in wardrobe, corridor, hallway, lobby, photographic darkroom, clothes-drying room, and other spaces of a specialised nature occupied neither frequently nor for extended periods.

### 30.3.3. Impact sound insulation of walls

Walls between a bathroom, sanitary compartment, laundry or a kitchen in a sole occupancy dwelling and a habitable room (other than a kitchen) in another sole occupancy dwelling are required to be of discontinuous construction.

Discontinuous construction means a cavity which is at least 20 mm wide between two separate wall leaves.

For masonry, where wall ties are required to connect the wall leaves, the ties are required to be of the resilient type.

For other than masonry, there is no mechanical linkage between the wall leaves except at the periphery.

For an aged care building this requirement only applies between a sole occupancy unit and a kitchen or laundry and to non-masonry walls.

For an aged care building it is also possible to show that the wall performs better in a laboratory than one of the deemed-to-satisfy acceptable walls.



### 30.3.4. Deemed to satisfy laboratory requirements

Walls and floor/ceilings between sole occupancy dwellings are required to have a laboratory  $R_w + C_{tr}$  not less than 50.

Floor/ceilings between sole occupancy dwellings are required to have a laboratory  $L_{n,w} + C_i$  of not more than 62.

Walls between a sole occupancy dwelling and a plant room, lift shaft, stairway, public corridor, public lobby or the like, or part of a different building classification, are required to have a laboratory  $R_w$  of not less than 50.

Floor/ceilings between a sole occupancy dwelling and a plant room, lift shaft, stairway, public corridor, public lobby or the like, or part of a different building classification, are required to have a laboratory  $R_w + C_{tr}$  of not less than 50 and a laboratory  $L_{n,w} + C_i$  of not more than 62.

Door assemblies between a sole occupancy dwelling and a stairway, public corridor, public lobby or the like are required to have a laboratory  $R_w$  of not less than 30.

Note the 5 dB allowance for flanking of airborne sound insulation in-situ.

### 30.3.5. Acceptable forms of construction for walls

The Building Code of Australia lists a number of wall construction types which are deemed to satisfy certain acoustical requirements.

**Table 30.2.** Internal walls - Acoustical rating deemed to be not less than.

Description	$R_w + C_{tr}$ (not less than)	$R_w$ (not less than)
Two leaves of 110 mm clay brick masonry with: (a) cavity not less than 50 mm between leaves; and (b) 50 mm thick glass wool insulation with a density of 11 kg/m <sup>3</sup> or 50 mm thick polyester insulation with a density of 20 kg/m <sup>3</sup> in the cavity.	50	50
Two leaves of 110 mm clay brick masonry with: (a) cavity not less than 50 mm between leaves; and (b) 13 mm cement render on each outside face.	50	50
Single leaf of 110 mm clay brick masonry with: (a) a row of 70 mm×35 mm timber studs or 64 mm steel studs at 600 mm centres, spaced 20 mm from the masonry wall; and (b) 50 mm thick mineral insulation or glass wool insulation with a density of 11 kg/m <sup>3</sup> positioned between studs; and (c) one layer of 13 mm plasterboard fixed to outside face of studs and outside face of masonry.	50	50

Description	$R_w + C_{tr}$ (not less than)	$R_w$ (not less than)
Single leaf of 90 mm clay brick masonry with: (a) a row of 70 mm×35 mm timber studs or 64 mm steel studs at 600 mm centres, spaced 20 mm from each face of the masonry wall; and (b) 50 mm thick mineral insulation or glass wool insulation with a density of 11 kg/m <sup>3</sup> positioned between studs in each row; and (c) one layer of 13 mm plasterboard fixed to studs on each outside face.	50	50
Single leaf of 150 mm clay brick masonry with 13 mm cement render on each face.	–	50
Single leaf of 220 mm clay brick masonry with 13 mm cement render on each face.	50	50
110 mm thick clay brick masonry with 13 mm cement render on each face.	–	45
110 mm thick concrete brickwork.	–	45
150 mm thick concrete panel.	50	50
150 mm thick concrete panel with one layer of 10 mm plasterboard fixed to 28 mm metal furring channels on each face.	–	50
200 mm thick concrete panel with one layer of 13 mm plasterboard or 13 mm cement render on each face.	50	50
100 mm thick concrete panel with: (a) a row of 64 mm steel studs at 600 mm centres, spaced 25 mm from the concrete panel; and (b) 80 mm thick polyester insulation or 50 mm thick glass wool insulation with a density of 11 kg/m <sup>3</sup> , positioned between studs; and (c) two layers of 13 mm plasterboard fixed to outside face of studs and one layer of 13 mm plasterboard fixed to outside face of concrete panel.	50	50
125 mm thick concrete panel with: (a) a row of 64 mm steel studs at 600 mm centres, spaced 20 mm from the concrete panel; and (b) 70 mm polyester insulation with a density of 9 kg/m <sup>3</sup> , positioned between studs; and (c) one layer of 13 mm plasterboard fixed to the outside face of the studs.	50	50
125 mm thick concrete panel.	–	50
100 mm concrete panel with 13 mm cement render or one layer of 13 mm plasterboard on each face.	–	50
190 mm thick concrete block work.	–	45
140 mm thick concrete block work, the face shell thickness of the blocks being not less than 44 mm and with: (a) 50 mm x 50 mm timber battens spaced at not more than 610 mm centres screw-fixed on one face of the blocks into resilient plugs with rubber inserts between battens and the wall; and (b) the face of the battens clad with 13 mm plasterboard.	–	45

Description	$R_w + C_{tr}$ (not less than)	$R_w$ (not less than)
Concrete panel - 100 mm thick.	–	45
75 mm thick autoclaved aerated concrete wall panel with: (a) a row of 64 mm steel studs at 600 mm centres, spaced 20 mm from the autoclaved aerated concrete wall panel; and (b) 75 mm thick glass wool insulation with a density of 11 kg/m <sup>3</sup> positioned between studs; and (c) one layer of 10 mm moisture resistant plasterboard or 13 mm fire protective grade plasterboard fixed to outside face of studs and outside face of autoclaved aerated concrete wall panel.	50	50
75 mm thick autoclaved aerated concrete wall panel with: (a) a row of 64 mm steel studs at 600 mm centres, spaced 35 mm from the autoclaved aerated concrete panel wall; and (b) 28 mm metal furring channels fixed to the outside face of the autoclaved aerated concrete wall panel, with 50 mm thick polyester insulation with a density of 9 kg/m <sup>3</sup> positioned between furring channels and one layer of 13 mm fire protective grade plasterboard fixed to furring channels; and (c) 105 mm thick glass wool insulation with a density of 7 kg/m <sup>3</sup> positioned between studs; and (d) one layer of 13 mm fire protective grade plasterboard fixed to the outside face of the studs.	50	50
Two leaves of 75 mm autoclaved aerated concrete wall panel with: (a) a cavity not less than 30 mm between panels containing 50 mm glass wool insulation with a density of 11 kg/m <sup>3</sup> ; and (b) one layer of 10 mm plasterboard fixed to outside face of each panel.	50	50
75 mm thick autoclaved aerated concrete wall panel with: (a) one layer of 10 mm moisture resistant plasterboard on one face; and (b) 28 mm metal furring channels and resilient mounts, 75 mm polyester insulation with a density of 9 kg/m <sup>3</sup> and 13 mm fire protective grade plasterboard fixed to the other face.	–	50
Two rows of 90×35 mm timber studs or two rows of 64 mm steel studs at 600 mm centres with: (a) an air gap not less than 20 mm between the rows of studs; and (b) 50 mm thick glass wool insulation or 60 mm thick polyester insulation with a density of 11 kg/m <sup>3</sup> ; positioned between one row of studs; and (c) two layers of 13 mm fire protective grade plasterboard or one layer of 6 mm fibre cement sheet and one layer of 13 mm fire protective grade plasterboard, fixed to outside face of studs.	50	50
Two rows of 64 mm steel studs at 600 mm centres with: (a) an air gap not less than 80 mm between the rows of studs; and (b) 200 mm thick polyester insulation with a density of 14 kg/m <sup>3</sup> ; positioned between studs; and (c) one layer of 13 mm fire-protective grade plasterboard and one layer 13 mm plasterboard on one outside face and one layer of 13 mm fire-protective grade plasterboard on the other outside face.	50	50



Description	$R_w + C_{tr}$ (not less than)	$R_w$ (not less than)
One row of 92 mm steel studs at 600 mm centres with: (a) 50 mm thick glass wool insulation with a density of 11 kg/m <sup>3</sup> or 60 mm thick polyester insulation with a density of 8 kg/m <sup>3</sup> , positioned between studs; and (b) two layers of 13 mm fire protective grade plasterboard or one layer of 6 mm fibre cement sheet and one layer of 13 mm fire protective grade plasterboard, fixed to each face.	–	50
One row of 64 mm steel studs with 2 layers of 16 mm fire-protective grade plasterboard fixed to each face.	–	45
One row of 64 mm steel studs with: (a) 1 layer of 16 mm fire-protective grade plasterboard fixed to one face; and (b) 50 mm thick mineral insulation or glass wool insulation with a density of 11 kg/m <sup>3</sup> positioned between the studs; and (c) 2 layers of fire-protective grade plasterboard fixed to the other face, the inner layer being 16 mm thick and the outer layer being 13 mm.	–	45
One row of 64 mm steel studs with 2 layers of 13 mm plasterboard on each face.	–	45

### 30.3.6. Acceptable forms of construction for floor/ceilings

The Building Code of Australia lists a number of floor/ceiling construction types which are deemed to satisfy certain acoustical requirements.

**Table 30.3.** Floor/ceilings - Acoustical rating deemed to be not less than.

Description	$R_w + C_{tr}$ (not less than)	$L_{n,w} + C_l$ (not less than)	$R_w$ (not less than)
150 mm thick concrete slab with: (a) 28 mm metal furring channels and isolation mounts fixed to underside of slab, at 600 mm centres; and (b) 65 mm thick polyester insulation with a density of 8 kg/m <sup>3</sup> , positioned between furring channels; and (c) one layer of 13 mm plasterboard fixed to furring channels.	50	62	50
200 mm thick concrete slab with carpet on underlay.	50	62	50
100 mm thick concrete slab.	45	–	45
75 mm thick autoclaved aerated concrete floor panel with: (a) 8 mm ceramic tiles with flexible adhesive and waterproof membrane, located above the slab; and (b) timber joists at 600 mm centres; and (c) R1.5 glass wool insulation positioned between timber joists; and (d) 28 mm metal furring channels and resilient mounts fixed to underside of joists; and (e) two layers of 13 mm plasterboard fixed to furring channels.	50	62	50

Description	$R_w + C_{tr}$ (not less than)	$L_{n,w} + C_l$ (not less than)	$R_w$ (not less than)
19 mm thick chipboard floor sheeting with: (a) 190×45 mm timber joists at 450 mm centres; and (b) R2.5 glass wool insulation positioned between timber joists; and (c) 28 mm metal furring channels and isolation mounts fixed to underside of joists, isolation mounts to be of natural rubber with a dynamic factor of not more than 30.1 and static deflection of not less than 3 mm at actual operating load; and (d) two layers of 16 mm fire protective grade plasterboard fixed to furring channels.	50	62	50
19 mm thick tongued and grooved boards with: (a) timber joists not less than 175 mm x 50 mm; and (b) 75 mm thick mineral insulation or glass wool insulation with a density of 11 kg/m <sup>3</sup> positioned between joists and laid on 10 mm thick plasterboard fixed to underside of joists; and (c) 25 mm thick mineral insulation or glass wool insulation with a density of 11 kg/m <sup>3</sup> laid over entire floor, including tops of joists before flooring is laid; and (d) secured to 75 mm×50 mm battens; and (e) the assembled flooring laid over the joists, but not fixed to them, with the battens lying between the joists.	45	–	45

### 30.3.7. Aged care buildings

A floor in an aged care building separating sole-occupancy units must have an  $R_w$  not less than 45.

A wall in an aged care building must have an  $R_w$  not less than 45 if it separates:

- (i) sole-occupancy units; or
- (ii) a sole-occupancy unit from a kitchen, bathroom, sanitary compartment (not being an associated ensuite), laundry, plant room or utilities room.

### 30.3.8. Services

(a) If a duct, soil, waste or water supply pipe, including a duct or pipe that is located in a wall or floor cavity, serves or passes through more than one sole occupancy dwelling, the duct or pipe must be separated from the rooms of any sole occupancy dwelling by construction with an  $R_w + C_{tr}$  not less than:

- (i) 40 if the adjacent room is a habitable room (other than a kitchen); or

- (ii) 25 if the adjacent room is a kitchen or non-habitable room.
- (b) If a storm water pipe passes through a sole-occupancy unit it must be separated in accordance with (a)(i) and (ii).

A flexible coupling must be used at the point of connection between the service pipes in a building and any circulating or other pump.

The required sound insulation of a floor or a wall must not be compromised by:

- (a) the incorporation or penetration of a pipe or other service element; or
- (b) a door assembly.

### **30.3.9. Construction**

Where a wall required to have sound insulation has a floor above, the wall must continue to:

- (i) the underside of the floor above; or
- (ii) a ceiling that provides the sound insulation required for the wall.

Where a wall required to have sound insulation has a roof above, the wall must continue to:

- (i) the underside of the roof above; or
- (ii) a ceiling that provides the sound insulation required for the wall.

### **30.3.10. Limitations of the acoustical requirements of the current Building Code of Australia**

It only applies to the noise transmitted between sole occupancy dwellings via a common wall or between a common space and a sole occupancy dwelling.

The impact sound insulation requirements for floor/ceilings are too low unless good quality underlay and carpet are installed on the floor. This is because it was deemed to be too expensive to require higher impact sound insulation.

The requirements only apply to new construction and not to existing buildings.

There is no requirement to have a certain percentage of or all constructions tested to see if they actually comply with the acoustical requirements.

There are currently no requirements to limit the ingress of noise into a building from outside the building or from other buildings.

## 30.4. Proposed Changes

### 30.4.1. *Ingress of road and railway noise into apartments*

The following requirements to limit the ingress of road and railway noise into apartments are under consideration for possible introduction on 1 May 2015.

This proposed change will only apply to a building containing 2 or more sole-occupancy units each being a separate dwelling.

It will only apply to road and rail airborne sound.

It will only apply where the jurisdiction declares a “designated sound exposure category” for buildings near road and rail transport corridors.

If the jurisdiction does not declare a “designated sound exposure category” then the provisions will not apply.

It will only apply to a “sound sensitive space”.

### 30.4.2. *Sound sensitive space*

Sound sensitive space means in a sole-occupancy unit:

- (a) a habitable room (other than a kitchen); or
- (b) any kitchen or non-habitable rooms with unimpeded connection to a habitable room,

that adjoins an external part of a building exposed to road or rail airborne sound of a designated sound exposure category.

### 30.4.3. *Designated sound exposure categories*

External part of building is exposed to road or rail airborne sound levels of

Category 1:

for daytime  $54 \text{ dB} < L_{\text{Aeq}} \leq 58 \text{ dB}$ , for night-time  $50 \text{ dB(A)} < L_{\text{Aeq}} \leq 54 \text{ dB}$

Category 2:

for daytime  $58 \text{ dB} < L_{\text{Aeq}} \leq 62 \text{ dB}$ , for night-time  $54 \text{ dB(A)} < L_{\text{Aeq}} \leq 58 \text{ dB}$

Category 3:

for daytime  $62 \text{ dB} < L_{\text{Aeq}} \leq 66 \text{ dB}$ , for night-time  $58 \text{ dB(A)} < L_{\text{Aeq}} \leq 62 \text{ dB}$



Category 4:

for daytime  $66 \text{ dB} < L_{Aeq} \leq 70 \text{ dB}$ , for night-time  $62 \text{ dB(A)} < L_{Aeq} \leq 66 \text{ dB}$

Category 5:

for daytime  $70 \text{ dB} < L_{Aeq} \leq 74 \text{ dB}$ , for night-time  $66 \text{ dB(A)} < L_{Aeq} \leq 70 \text{ dB}$

### 30.4.4. Verification of external sound insulation requirement

Compliance for the attenuation of the transmission of road or rail airborne sound into a sound sensitive space in a sole-occupancy unit is verified when it is calculated through modelling that the average A-weighted sound pressure level ( $L_{Aeq}$ ) in the sound sensitive space will not exceed:

- (a) 35 dB(A) ( $L_{Aeq}$ ) during night-time (10.00 pm to 7.00 am) in a bedroom; and
- (b) 40 dB(A) ( $L_{Aeq}$ ) during daytime (7.00 am to 10.00 pm) in other rooms,

when subjected to an average A-weighted sound pressure level ( $L_{Aeq}$ ) of the appropriate designated sound exposure category

### 30.4.5. Deemed-to-satisfy laboratory requirements for external parts of a sound sensitive space

When subjected to a designated sound exposure category

Wall,  $R_w + C_{tr} \geq 50$

Floor,  $R_w + C_{tr} \geq 50$

Roof,  $R_w + C_{tr} \geq 45$

**Table 30.4.** Minimum  $R_w + C_{tr}$  of closed window including integral window seals in bedroom.

Category	1	2	3	4	5
Area of windows (W) as % of room floor area (F)					
$W/F \leq 20 \%$	25	28	31	34	37
$20 \% < W/F \leq 40 \%$	28	31	34	37	40
$40 \% < W/F \leq 60 \%$	31	34	37	40	
$60 \% < W/F \leq 80 \%$	34	37	40		
$80 \% < W/F \leq 100 \%$	37	40			
$100 \% < W/F \leq 120 \%$	40				
$120 \% < W/F$					

Note that the lack of an entry in the cell of a table in this chapter means that the situation that the cell covers is not permitted.

**Table 30.5.** Minimum  $R_w + C_{tr}$  of closed window including integral window seals in other sound sensitive spaces.

Category	1	2	3	4	5
Area of windows (W) as % of room floor area (F)					
$W/F \leq 20\%$	22	25	28	31	34
$20\% < W/F \leq 40\%$	25	28	31	34	37
$40\% < W/F \leq 60\%$	28	31	34	37	40
$60\% < W/F \leq 80\%$	31	34	37	40	
$80\% < W/F \leq 100\%$	34	37	40		
$100\% < W/F \leq 120\%$	37	40			
$120\% < W/F \leq 140\%$	40				
$140\% < W/F$					

**Table 30.6.** Minimum  $R_w + C_{tr}$  of external door.

Category	1	2	3	4	5
$R_w + C_{tr}$	30	30	33	35	40

### 30.4.6. External parts of a sound sensitive space

(i) Wall, floor and roof parts (not including service penetration areas) must have joints filled solid.

(ii) The internal lining system aligning with the external part of the sound sensitive space must be close fitting and have sealed joints.

(iii) Sound insulation seals must be installed to external doors or windows as follows:

(A) Appropriate sound insulation between the external frame perimeter and wall opening.

(B) A hinged door must have a foam or rubber compression strip or the like to the internal perimeter frame and the wall opening as well as a drop seal (other than a brush type) attached to the bottom of the door.

(C) An openable window must have a standard or acoustic seal between the internal perimeter frame and the closed window.

### 30.4.7. Acceptable forms of construction

The Building Code of Australia forms the first two volumes of the National Construction Code. It gives acceptable forms of construction and the acoustical requirements that each acceptable form of construction is deemed to satisfy. There are tables of these acceptable forms of construction for

Separating and external walls

Floors

Roofs

Windows

External doors other than windows.

**Table 30.7.** Windows -  $R_w + C_{tr}$  deemed to be no less than.

Glazing system	Opening window with acoustic seals	Fixed window
Single glass pane (4 mm to 6 mm thickness) sealed into a frame	25	25
Single glass pane (more than 6 mm to 10 mm thickness) sealed into a frame	31	31
Single glass pane (more than 10 mm thickness) sealed into a frame	34	34
Double glass panes (4 to 6 mm thickness) sealed into a frame with a 6 mm to 12 mm gap	34	34
Double glass panes (more than 6 mm thickness) sealed into a frame with a 100 mm to 125 mm gap	37	37

**Table 30.8.** Doors -  $R_w + C_{tr}$  deemed to be not less than.

Description	$R_w + C_{tr}$ (not less than)
38 mm solid core door, side hinged, with an acoustic door sealing system	30
50 mm solid core door, side hinged, with an acoustic door sealing system	33

**Table 30.9.** External Walls – Acoustical rating deemed to be not less than.

Description	$R_w + C_{tr}$ (not less than)	$R_w$ (not less than)
Two leaves of 110 mm clay brick masonry with: (a) a 50 mm cavity between leaves; and (b) 50 mm thick glass or mineral wool insulation with a density of 11 kg/m <sup>3</sup> or 50 mm thick polyester insulation with a density of 20 kg/m <sup>3</sup> in the cavity; and (c) one layer of 13 mm plasterboard battened 50 mm from the inside face	50	50
Single leaf of 110 mm clay brick masonry with: (a) a row of 70 mm x 35 mm timber studs or 64 mm steel studs at 600 mm centres; and (b) a 25 mm cavity; and (c) 50 mm thick glass or mineral wool insulation with a density of 11 kg/m <sup>3</sup> or 75 mm thick polyester insulation with a density of 14 kg/m <sup>3</sup> , positioned between studs; and (d) 13 mm cement render on the outside masonry face; and (e) one layer of 13 mm fire-protective grade plasterboard fixed to the inside face of studs.	50	50
Single leaf of 90 mm clay brick masonry with: (a) a row of 70 mm x 35 mm timber studs at 600 mm centres; and (b) a 25 mm cavity; and (c) 75 mm thick glass or mineral wool insulation with a density of 11 kg/m <sup>3</sup> or 75 mm thick polyester insulation with a density of 14 kg/m <sup>3</sup> , positioned between studs; and (d) one layer of 10 mm plasterboard fixed to the inside face of studs.	50	50
Single leaf of 220 mm clay brick masonry with: (a) 13 mm render on the outside face; and (b) one layer of 13 mm fire-protective grade plasterboard battened 50 mm from the inside face.	50	50
125 mm thick concrete panel with: (a) a row of 64 mm steel studs at 600 mm centres; and (b) a 25 mm cavity; and (c) 50 mm thick glass or mineral wool insulation with a density of 11 kg/m <sup>3</sup> or 50 mm thick polyester insulation with a density of 14 kg/m <sup>3</sup> , positioned between studs; and (d) one layer of 13 mm plasterboard fixed to the inside face of the studs.	50	50
100 mm thick autoclaved aerated concrete wall panel with: (a) a row of 70 mm timber studs at 600 mm centres; and (b) a 50 mm cavity; and (c) 75 mm thick glass or mineral wool insulation with a density of 11 kg/m <sup>3</sup> or 75 mm thick polyester insulation with a density of 14 kg/m <sup>3</sup> , positioned between studs; and (d) one layer of 13 mm fire-protective grade plasterboard fixed to the inside face of the studs.	50	50

Description	$R_w + C_{tr}$ (not less than)	$R_w$ (not less than)
Two rows of 70 mm studs at 600 mm centres, staggered at 300 mm (120 mm depth of frame), with: (a) 25 mm battens fixed to the outside face of studs; and (b) one layer of 11 mm fibre cement weatherboards fixed to the outside of the battens and 6 mm fibre cement sheets fixed to the inside of the battens; and (c) 75 mm thick glass or mineral wool insulation with a density of 11 kg/m <sup>3</sup> or 75 mm thick polyester insulation with a density of 14 kg/m <sup>3</sup> , positioned between studs; and (d) two layers of 13 mm plasterboard fixed to the inside face of studs.	50	50
One row of 90 mm studs at 600 mm centres with: (a) resilient steel channels fixed to the outside face of studs; and (b) one layer of 11 mm fibre cement weatherboards fixed to the outside of the channels and 6 mm fibre cement sheets fixed to the inside of the channels; and (c) 75 mm thick glass or mineral wool insulation with a density of 11 kg/m <sup>3</sup> or 75 mm thick polyester insulation with a density of 14 kg/m <sup>3</sup> , positioned between studs; and (d) two layers of 16 mm fire-protective grade plasterboard fixed to the inside face of studs.	50	50

**Table 30.10.** Additional Floors – Acoustical rating deemed to be not less than.

Description	$R_w + C_{tr}$ (not less than)	$R_w$ (not less than)
200 mm thick concrete slab.	50	50
150 mm thick concrete slab with: (a) 28 mm metal furring channels and isolation mounds fixed to underside of slab at 600 mm centres; and (b) 30 mm thick glass or mineral insulation with a density of 11 kg/m <sup>3</sup> or 30 mm thick polyester insulation with a density of 14 kg/m <sup>3</sup> , positioned between furring channels; and (c) one layer of 10 mm plasterboard fixed to furring channels.	50	50

**Table 30.11.** Roofs –  $R_w + C_{tr}$  deemed to be not less than.

Description	$R_w + C_{tr}$ (not less than)
150 mm thick concrete slab with: (a) 28 mm metal furring channels fixed to underside of slab, at 600 mm centres; and (b) 30 mm thick glass or mineral wool insulation with a density of 11 kg/m <sup>3</sup> or 30 mm thick polyester insulation with a density of 14 kg/m <sup>3</sup> , positioned between furring channels; and (c) one layer of 10 mm plasterboard fixed to furring channels.	45

Description	$R_w + C_{tr}$ (not less than)
Metal decking and sarking with: (a) 210 mm thick glass or mineral wool insulation with a density of 7 kg/m <sup>3</sup> or 210 mm thick polyester insulation with a density of 10 kg/m <sup>3</sup> , positioned between ceiling joists; and (b) two layers of 13 mm plasterboard ceiling on resilient mounts and furring channels.	45
Concrete or terracotta tiles with: (a) 165 mm thick glass or mineral wool insulation with a density of 7 kg/m <sup>3</sup> or 200 mm thick polyester insulation with a density of 14 kg/m <sup>3</sup> , positioned between ceiling joists; and (b) two layers of 10 mm ceiling grade plasterboard ceiling.	45

### 30.4.8. Limitations of proposed changes in protecting people from external noise

People are protected from road and rail airborne sound but not necessarily from other forms of external sound.

People are only protected when they are in a designated sound exposure category.

People are not protected when they are outside the building.

People are only protected when they are in a building containing two or more sole-occupancy units each being a separate dwelling.

People are only protected when they are in a sound sensitive space.

People are only protected when in a building constructed after the proposed changes come into force.

People are not fully protected when their windows and doors are open.

Protection against external noise in most parts of Australia will require whole dwelling air-conditioning for at least some parts of the year because of the climate.

## 30.5. Association of Australian Acoustical Consultants

### 30.5.1. Guideline for Apartment and Townhouse Acoustic Rating

The Association of Australian Acoustical Consultants (AAAC) [2] has issued a Guideline for Apartment and Townhouse Acoustic Rating [3]. This guideline rates various aspects of the acoustical performance of a dwelling using a rating which goes from 2 to 6 stars. The overall rating is the average of the individual ratings.



### 30.5.2. External noise intrusion

**Table 30.12.** External noise intrusion in dB(A).

Star rating	2	3	4	5	6
<b>Bedrooms 22:00 to 07:00</b>					
Continuous noises $L_{Aeq} \leq$	36	35	32	30	27
Intermittent noises $L_{Amax,ave} \leq$	50	50	45	40	35
<b>Other habitable rooms including open kitchens 06:00 to 00:00</b>					
Continuous noises $L_{Aeq} \leq$	41	40	37	35	32
Intermittent noises $L_{Amax,ave} \leq$	55	55	50	45	40

### 30.5.3. Internal building services and appliances

**Table 30.13.** Internal building services and appliances in dB(A).

Star rating	2	3	4	5	6
<b>Bedrooms</b>					
Continuous noises $L_{Aeq,adj} \leq$	36	35	32	30	27
Intermittent noises $L_{Amax,ave} \leq$	45	40	35	30	27
<b>Other habitable rooms including open kitchens</b>					
Continuous noises $L_{Aeq,adj} \leq$	41	40	35	30	27
Intermittent noises $L_{Amax,ave,adj} \leq$	55	45	40	35	32
<b>Wet areas including bathrooms, ensuites and laundries</b>					
Continuous noises $L_{Aeq,adj} \leq$	55	50	45	42	40
Intermittent noises $L_{Amax,ave,adj} \leq$	60	55	48	42	40

Air-conditioning and ventilation systems, lifts, hydraulics wastes and water supply systems, garbage chutes, spa baths and appliances of adjacent apartments are included. Appliances such as spa baths and dishwashers in the same tenancy are excluded. If the noise contains pronounced tonal or impulsive characteristics, a penalty adjustment (adj) shall be applied. If these characteristics are clearly audible a 5 dB(A) penalty shall be applied. If the characteristics are just audible then a 2 dB(A) penalty shall be applied. The noise measurements are made at relevant positions but no closer than 1.5 metres from the noise source.



### 30.5.4. Inter-tenancy sound insulation

Table 30.14. Inter-tenancy sound insulation.

Star Rating	2	3	4	5	6
<b>Airborne sound insulation for walls and floors</b>					
Between separate tenancies $D_{nT,w} + C_{tr} \geq$	35	40	45	50	55
Between a lobby/corridor & bedroom $D_{nT,w} + C_{tr} \geq$	30	40	40	45	50
Between a lobby/corridor & living area $D_{nT,w} + C_{tr} \geq$	25	40	40	40	45
Corridor/foyer to living space via door(s) $D_{nT,w} \geq$	20	25	30	35	40
<b>Impact Isolation of floors</b>					
Between separate tenancies $L_{nt,w} \leq$	65	55	50	45	40
Between all other spaces & tenancies $L_{nt,w} \leq$	65	55	50	45	40
<b>Impact isolation of walls</b>					
Between separate tenancies	No	Yes	Yes	Yes	Yes
Between common areas & tenancies	No	No	No	Yes	Yes

## 30.6. History of the regulation of building acoustics in Australia

A history of the regulation of building acoustics in Australia up to 2000 is given in (Davy, 2000) [4]. On 5 April 1974, sound insulation requirements were introduced into the New South Wales (NSW) building code. The original requirements for sound insulation in the Building Code of Australia (BCA) were based on the original NSW requirements. However, when the July 1990 version of the BCA was published, its Victorian appendix deleted the application of the sound insulation requirements in Victoria. When CSIRO was trying to obtain funding for a round robin on the wall impact sound insulation measurement method in the BCA in February 1993, CSIRO was told that there was a possibility that the sound insulation requirements would be deleted from the BCA because Victoria did not use them. Victoria finally adopted the sound insulation requirements of the BCA, more than twenty years after NSW, when amendment 7 was issued on 1 November 1994. This time difference is probably due to the much larger percentage of multi-dwelling buildings in NSW.

The original acoustical requirements of the BCA were less strict than those current in most other developed countries. They were reportedly based



on the requirements applying in England and Wales immediately after the Second World War. Thus, on 28 August 1995, the Association of Australian Acoustical Consultants (AAAC) proposed major increases to the sound insulation requirements. Although the proposed increases were probably justified acoustically, CSIRO was concerned about the economic cost. In February 1999, the AAAC submitted their proposal again and included estimates of the cost increases of their proposed changes. However the proposed AAAC changes were not included in the BCA until 1 May 2004. Only about half the states and territories initially adopted the new acoustical requirements. At the beginning of 2014, only the Northern Territory has not adopted the new acoustical requirements.

In 2007, the Australian Building Codes Board (ABCB) initiated a project to examine the feasibility of introducing requirements for apartments for the attenuation of external noise from roads and railways. During development of the scope of the project, it was expanded to include other residences such as houses, hotels, aged care units, and other noise sensitive buildings such as hospital wards, libraries and places of worship. A scoping study was produced (Greer, 2007) [5]. A working group of state building control and planning officials and industry acoustical experts was established. This working group developed a Consultation Regulatory Impact Statement (RIS) for the application to the wider range of residences. Because of comments received on the Consultation RIS, the scope of the proposal was reduced to only cover apartments as originally proposed. This scope is consistent with a number of states which have already regulated the attenuation of external noise into apartments.

The draft 2014 National Construction Code (NCC) (whose first two volumes are the BCA) included requirements for the attenuation of external road and railway noise into apartments. However these requirements were deleted from the final version which will come into force on 1 May 2014. The states and territories are considering whether to adopt these requirements on 1 May 2015.

As mentioned above, the Association of Australian Acoustical Consultants (AAAC) has developed a star rating system. The latest version (Greer, 2010) was published in September 2010.

### 30.7. Conclusion

This chapter has presented the current acoustical requirements of the National Construction Code of Australia. The current version of the

proposed extension to regulate the ingress of external noise has been given. The shortcomings of both the current regulations and their proposed extension have been described. The star rating system of the Association of Australian Acoustical Consultants for the acoustical performance of residences has been summarised. The chapter finished with a brief history of the regulation of building acoustics in Australia.

## 30.8. References

- [1] <http://www.abcb.gov.au/>
- [2] <http://www.aaac.org.au/>
- [3] Association of Australian Acoustical Consultants (2010). Guideline for Apartment and Townhouse Acoustic Rating. [http://www.aaac.org.au/au/aaac/downloads\\_website/AAAC%20Guideline%20for%20Apartment%20and%20Townhouse%20Acoustic%20Rating%202010.pdf](http://www.aaac.org.au/au/aaac/downloads_website/AAAC%20Guideline%20for%20Apartment%20and%20Townhouse%20Acoustic%20Rating%202010.pdf).
- [4] J.L. Davy (2000). The regulation of sound insulation in Australia. Proceedings of Acoustics 2000 - Putting the science and technology to work, Australian Acoustical Society Annual Conference 2000, Joonalup Resort, Western Australia, 15-17 November 2000, pp 155-160. [http://www.acoustics.asn.au/conference\\_proceedings/2000-Putting%20Science%20and%20Technology%20to%20Work.pdf](http://www.acoustics.asn.au/conference_proceedings/2000-Putting%20Science%20and%20Technology%20to%20Work.pdf)
- [5] G.Greer (2007). External Noise into Residential Apartment Buildings Scoping Study Report 60021921-GG01.REP.03.DOC Revision 03 June 2007, Bassett Acoustics, Sydney, Australia [http://www.abcb.gov.au/sitecore/shell/Controls/Rich%20Text%20Editor/~/\\_media/Files/Download%20Documents/Major%20Initiatives/External%20Noise/External%20Noise%20into%20Residential%20Apartment%20Buildings%20-%20Scoping%20Study%20Report.ashx](http://www.abcb.gov.au/sitecore/shell/Controls/Rich%20Text%20Editor/~/_media/Files/Download%20Documents/Major%20Initiatives/External%20Noise/External%20Noise%20into%20Residential%20Apartment%20Buildings%20-%20Scoping%20Study%20Report.ashx)



# Building acoustics throughout Europe

## Volume 2: Housing and construction types country by country

# 31

## New Zealand

Author:  
**Jeffrey Mahn**

University of Canterbury, Christchurch, New Zealand  
[jeffrey.mahn@canterbury.ac.nz](mailto:jeffrey.mahn@canterbury.ac.nz)

© COST Office and authors (2014)

The responsibility and copyright of each chapter belongs to the author(s). When quoting, it is mandatory to make proper reference to the book and/or the authors of the quoted chapter. Permission from copyright holder is required in case of reproducing contents of images, diagrams, tables or other material from other copyright holders.



## CHAPTER

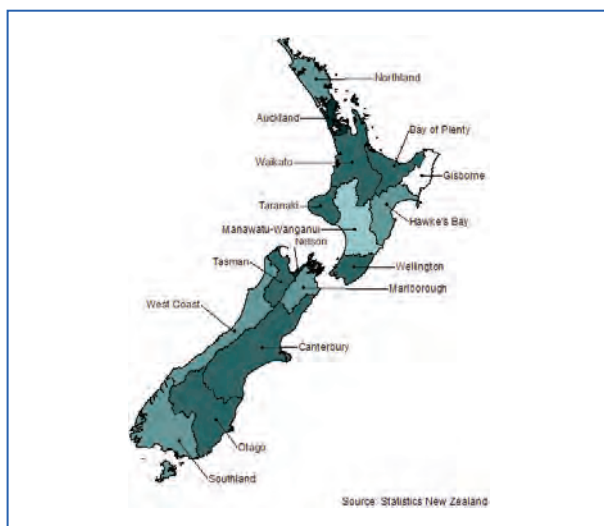
## 31

## New Zealand

## 31.1. Design and acoustic performance

### 31.1.1. Overview of housing stock

New Zealand has a population of 4,242,048 inhabitants according to the 2013 Census [1]. This represents a 5.3% increase in the population since the 2006 Census. The majority of the population (76%) lives on the North Island. The Auckland region on the North Island has the largest population (1,415,550) followed by the Canterbury Region on the South Island (539,433) as shown in *Figure 31.1*.



*Figure 31.1.* New Zealand regions from Statistics New Zealand [2].

There were 1,570,695 occupied dwellings in New Zealand in 2013. This number does not include unoccupied holiday homes, dwellings being repaired or renovated or private dwellings whose occupants were away at the time of the Census. The number of occupied dwellings has been steadily increasing since the 2001 Census as shown in *Figure 31.2*.

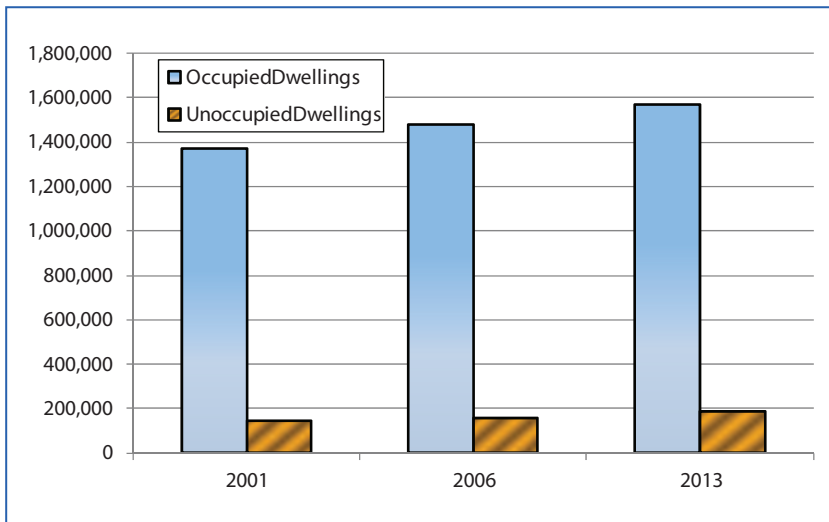


Figure 31.2. New Zealand housing stock from 2001 to 2013 [1].

The majority of the occupied dwellings in New Zealand have three bedrooms as shown in Figure 31.3.

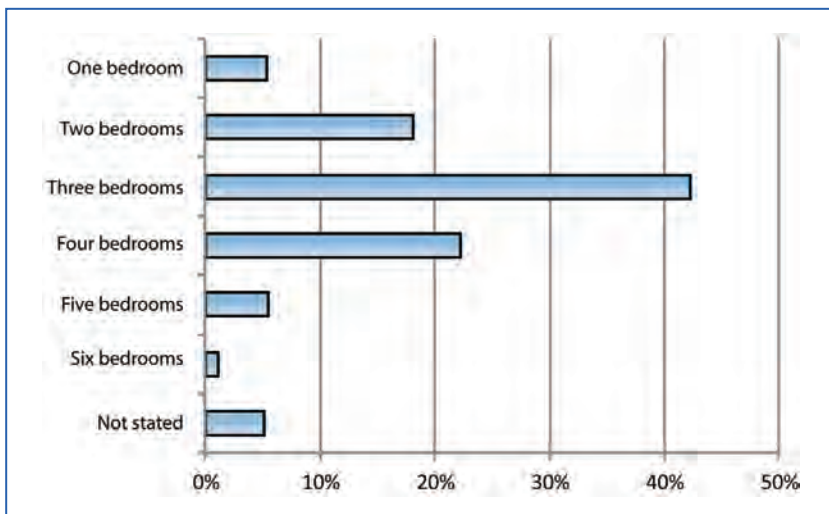
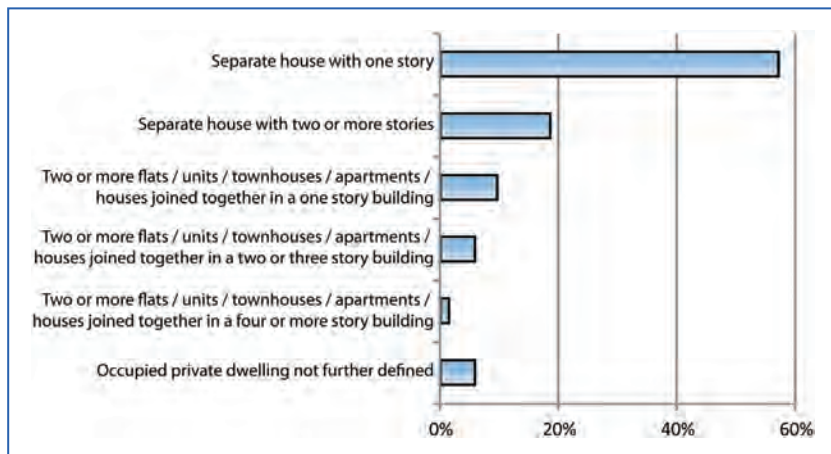


Figure 31.3. Number of bedrooms for the occupied private dwellings as recorded in the 2013 Census [3].



In terms of dwelling type, the majority of the dwellings in New Zealand are separate houses as shown in Figure 31.4. Not shown in the figure are housing types which represented less than 1% of the total number of dwellings.



**Figure 31.4.** Percentage of dwelling types for the occupied dwelling types as recorded in the 2013 Census [4].

The figure shows that one story, separate houses represent the majority (57%) of the occupied dwellings in New Zealand. Separate houses made up 76% of the occupied dwellings which represents a decrease from 81.3% in 2001. Row houses make up 10% of the occupied dwellings and multi-tenancy dwellings make up 7% of the occupied dwellings.

Historically, multi-tenancy dwellings have not been successful in New Zealand in terms of the acoustic comfort of the residents. Surveys have identified acoustical problems for apartment occupants from other, attached dwellings and from outside sources [5].

## 31.2. Building regulations and sound insulation

### 31.2.1. National requirements

Clause G6 of the New Zealand Building Code [6] defines the requirements for airborne and impact sound insulation based laboratory measurements according to ASTM International standards (STC and IIC) [7, 8]. The current requirements, regardless of dwelling type are shown in Table 31.1.

**Table 31.1.** Current requirements for airborne and impact sound insulation.

Airborne insulation of walls, floors and ceilings	STC $\geq$ 55
Impact insulation of floors	IIC $\geq$ 55

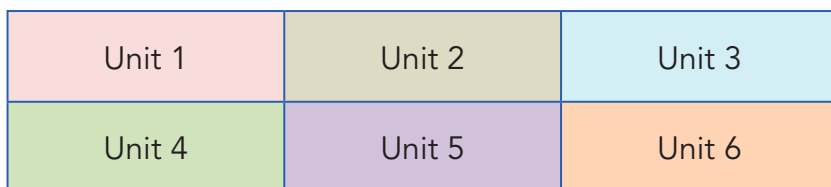
Clause G6 also includes a non-binding verification method for field testing the airborne and impact sound insulation of building elements. The measurements made according to ASTM E 336 [9] and ISO 140-7 [10] and the field measured single number quantities are defined in terms of the ASTM International quantities FSTC and FIIC as shown in Table 31.2.

**Table 31.2.** Field verification for airborne and impact sound insulation.

Airborne insulation of walls, floors and ceilings	FSTC $\geq$ 50
Impact insulation of floors	FIIC $\geq$ 50

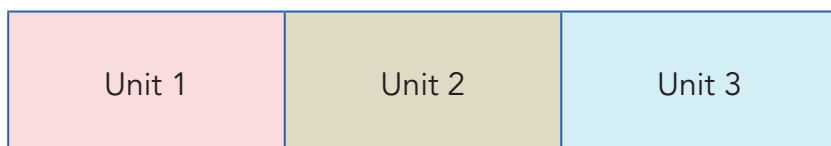
### 31.2.2. City specific requirements

Although the New Zealand Building Code does not require field measurements to ensure compliance with Clause G6, The Auckland City Council has adopted mandatory acoustic inspections for multi-storied residential tenancies where units are above and adjacent to each other [11] as shown in Figure 31.5.



**Figure 31.5.** Multi-story residential units with units adjacent and above.

However, the Auckland City Council requirements for acoustic inspections would not apply in the case of single or two story dwellings which are adjacent to each other as shown in Figure 31.6.



**Figure 31.6.** Residential units with units adjacent but not above. Acoustic inspections are not required in Auckland City for this situation.



The acoustic inspection is conducted in new buildings and in most cases when alternations are made to the elements of existing buildings such as when new party walls are constructed. The acoustic testing is undertaken by a suitably qualified acoustic engineer. The requirements shown in Table 31.2 must be achieved for the building to pass the acoustic inspection.

### 31.2.3. Comparison of the acoustic requirements versus those in Europe

In order to compare the existing New Zealand airborne sound insulation requirement to those in Europe, the STC rating used in New Zealand must be converted into an equivalent weighted apparent sound reduction index  $R'_w$ . Although there is no direct relation between STC and  $R'_w$ , the conversion from STC was based on the STC rating measured in the laboratory often being similar to the weighted sound reduction index  $R_w$  [12]. While this may not always be the case due to the 8 dB rule used to calculate the STC rating [8] and due to the difference in the 1/3 octave bands considered, the approximation was applied in the conversion from STC to  $R_w$ . The FSTC rating used by the New Zealand Building Code for verification of compliance could not be directly compared to  $R'_w$  since ASTM 336 [9] requires that the flanking paths be shielded during the measurement of the transmission loss in the field.

For the estimation of  $R'_w$  from  $R_w$ , there is anecdotal evidence that the value of  $R'_w$  is typically within 3 dB to 5 dB of the value of  $R_w$  [13]. Alternatively, Taibo and Dayan [14] used a linear fit to the data to determine the relationship between  $R_w$  and  $R'_w$  to be  $R'_w = 2.2 + 0.8R_w$ . This relationship would result in a conversion from  $R_w = 55$  dB to  $R'_w = 46$  dB. However, a relationship based on the same set of data that seems to better predict the  $R'_w$  measured by Taibo and Dayan is  $R'_w = 1.92 + 0.85R_w$ . Based on this equation, the conversion from  $R_w = 55$  dB to  $R'_w = 49$  dB which would be a much better fit with the anecdotal evidence and with the maximum difference between  $R_w$  and  $R'_w$  measured by Taibo and Dayan to be 5 dB for a  $R_w = 43$  dB wall.

The conversion for the impact sound insulation from IIC to  $L'_{nw}$  was based on a study by Warnock [15]. Warnock found that the 8 dB limitation in ASTM E989 [7] meant that the ISO  $L_{nw}$  rating [16] is not always 110 - IIC but is nearly so. Since the measurement of FIIC is comparable to that for  $L'_{nw}$ , the same relationship is expected to hold as for IIC and  $L_{nw}$ . Therefore, the estimate that  $L'_{nw} = 110$  - FIIC was used for this study.



The converted acoustic requirements for New Zealand are shown in Table 31.3.

**Table 31.3.** *Estimated airborne and impact insulation.*

Airborne insulation of walls, floors and ceilings	$R'_w \geq 49$
Impact insulation of floors	$L'_{nw} \leq 60$

These values may be compared against the sound and impact insulation requirements of the COST members as was done in the paper by Rasmussen [17]. One such study [13] found that in terms of the airborne sound insulation, New Zealand was lower than the COST member countries. However, in terms of impact sound insulation, the existing New Zealand requirement is in the lower 1/3 of the countries included in the paper by Rasmussen.

### 31.3. Discussion

Unlike many COST countries, the housing stock in New Zealand is predominantly single story, stand alone houses. Row houses and multi-tenancy buildings make up only 17% of the occupied dwellings. The focus on stand alone houses may be why the airborne sound insulation requirements are lower than those of the COST countries included in the study by Rasmussen [17]. As cities such as Auckland and Christchurch begin to focus on the construction of multi-tenancy buildings in the city centers to arrest urban sprawl, the acoustic requirements of the New Zealand Building Code will need to be reassessed. A proposal for revised acoustic requirements has been under consideration for a number of years [5, 13]. The limits for airborne and impact sound insulation in the proposal are based on field measured values rather than laboratory measurements as is currently the case.

### 31.4. References

- [1] "Statistics New Zealand," <http://www.stats.govt.nz/Census/2013-census/profile-and-summary-reports.aspx>, Accessed 5 January 2014.
- [2] "Statistics New Zealand," <http://www.stats.govt.nz>, Accessed 5 January 2014.
- [3] Statistics New Zealand, "Number of Bedrooms for Occupied Dwellings 2013 Census," <http://www.stats.govt.nz/~media/Statistics/Browse%20for%20stats/2013CensusUsuallyResidentPopulationCounts/HOTP2013Census/2013-census-urpc-tables.xls>, Accessed 5 January 2014.

- [4] Statistics New Zealand, "Occupied Dwelling Type for Occupied Dwellings 2013 Census," <http://www.stats.govt.nz/~media/Statistics/Browse%20for%20stats/2013CensusUsuallyResidentPopulationCounts/HOTP2013Census/2013-census-urpc-tables.xls>, Accessed 5 January 2014.
- [5] "Proposed Changes to Building Code Requirements and Associated Documents for Protection from Noise," New Zealand Department of Building and Housing, Wellington, New Zealand, 2010.
- [6] Compliance Document for New Zealand Building Code - Clause G6 - Airborne and Impact Sound, New Zealand Department of Building and Housing.
- [7] ASTM E989 - 06 Standard Classification for Determination of Impact Insulation Class (IIC), West Conshohocken, PA, USA, ASTM International.
- [8] ASTM E413 - 10 Classification for Rating Sound Insulation, West Conshohocken, PA, USA, ASTM International.
- [9] ASTM E336 - 10 Standard Test Method for Measurement of Airborne Sound Attenuation between Rooms in Buildings, West Conshohocken, PA, USA, ASTM International.
- [10] ISO 140-7:1998 Acoustics - Measurement of Sound Insulation in Buildings and of Building Elements - Part 7: Field Measurements of Impact Sound Insulation of Floors, Geneva, International Organization for Standardization.
- [11] "Practice Note: G6 Airborne and Impact Sound," Auckland Council, Auckland, New Zealand, Report AC2204 Version 3, 2013.
- [12] Crocker, M. J., Handbook of Acoustics, Wiley, New York, 1998.
- [13] Mahn, J., Davy, J. L., and Pearse, J., The Acoustic Requirements of Dwellings in New Zealand, Proceedings of Forum Acusticum 2011, Aalborg, Denmark, 2011.
- [14] Taibo, L. and Dayan, H. G. D., Comparison of Laboratory and Field Sound Insulation Measurements of Party Walls and Facade Elements, The Journal of the Acoustical Society of America, 1984, 75(5), 1522-1531.
- [15] Warnock, A., Low-Frequency Impact Sound Transmission through Floor Systems, INCE Conference Proceedings, 2000, 204(1), 1-10.
- [16] ISO 717-2:1996 Acoustics - Rating of Sound Insulation in Buildings and of Building Elements - Part 2: Impact Sound Insulation, Geneva, International Organization for Standardization.
- [17] Rasmussen, B., Sound Insulation between Dwellings - Requirements in Building Regulations in Europe, Applied Acoustics, 2010, 71(4), 373-385. <http://dx.doi.org/10.1016/j.apacoust.2009.08.011>.

***“Building acoustics throughout Europe”*** is a summary of the work undertaken during four years of close co-operation and discussions between experts from 32 countries participating in COST Action TU0901 *“Integrating and Harmonizing Sound Insulation Aspects in Sustainable Urban Housing Constructions”*.

***“Building acoustics throughout Europe”*** is a two-volume publication. The contents of Volume 1, ***“Towards a common framework in building acoustics throughout Europe”***, range from the diverse existing situation in Europe concerning sound insulation requirements and classification schemes through subjective perception of neighbour noise to proposals for harmonized sound insulation descriptors and an acoustic classification scheme for dwellings. The book also includes overview chapters on typical European housing constructions, their design and acoustic performance and workmanship errors. Volume 2, ***“Housing and construction types country by country”*** consists of country chapters describing the national housing stock, construction types and related sound insulation performance in countries involved in COST TU0901.

The findings made by COST TU0901 and the co-operation established are excellent stepping stones for continued research and future development towards future quieter European homes.

*“TU0901 has delivered a series of harmonization proposals, identified future research areas for industry and government and led to unparalleled knowledge exchange of which it has been an honour to be part of”.*

Professor Sean Smith, Chair of TU0901 WG3 Institute for Sustainable Construction, Edinburgh Napier University, UK



COST is supported  
by EU RTD Framework Programme



ESF provides the COST Office  
through a European Commission contract